

# Russellstoll®

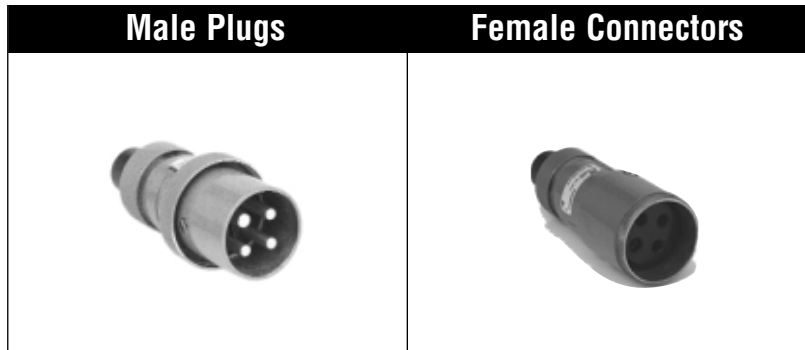









## FS/FD™ 10-30A Metallic Connections — Ordering Information

Metallic Plugs, Connectors, Receptacles and Reverse Service Female Plugs/Male Inlets.

10-30A, Maximum 600VAC/250VDC



\*See also DuraGard section for Thermoplastic families.

Poles Wires	Amperes	Voltage	Polarization (Receptacle)	Aluminum	Cast Brass	Aluminum	Cast Brass
2P/3W	15 A	250 V		3720U-2	3720BU-2	3913U-2	3913BU-2
		277 VAC		3720U-3	3720BU-3	3913U-3	3913BU-3
		480 VAC		3720U-4	3720BU-4	3913U-4	3913BU-4
		600 VAC		3720U-5	3720BU-5	3913U-5	3913BU-5
	20 A	250 VAC		3720	3720B	3913	3913B
		125 V		3720U-1	3720BU-1	3913U-1	3913BU-1
		250 VAC		3750	3750B	3933	3933B
	3P/4W	10 A	600 VAC		3730	3730B	3914
15 A		250 VAC		3730	3730B	3914	3914B
20 A		600 VAC		3760	3760B	3934	3934B
30 A		250 VAC		3760	3760B	3934	3934B

### Standard Cable Bushing Hole Diameter

Prefix	Hole Dia.	Prefix	Hole Dia.	Prefix	Hole Dia.
3720		3730		3750, 3760	
3913	5/8"	3914	1 1/16"	3933, 3934	3/4"
3789		3790		3809, 3810	

**Cable Bushings** – oil-resistant, neoprene cable bushing furnished with hole sizes listed above. Other hole sizes are available at no extra cost when specified on order. See page 127 for available sizes.

For other plug and connector accessories see pages 124 and 125.

Plugs can be furnished with adapters to accommodate rigid conduit or standard connectors for armored cable or flexible conduit, see page 127.

**Screw Caps For Connectors** can be furnished with screw cap and chain at extra cost. For Kits order:

- 9X2PSC 20A Screw Cap
- 9X3PSC 30A Screw Cap
- F26874C 30A Plug Cup Cap

# Russellstoll®

## FS/FD™ 10-30A Metallic Connections

Metallic Plugs, Connectors, Receptacles and Reverse Service Female Plugs/Male Inlets.  
10-30A, Maximum 600VAC/250VDC

Female Receptacles		Reverse Service			
		Female Plugs 		Male Receptacles 	
		(Inlets)			
Aluminum with Box **	Cast Brass with Box **	Aluminum	Cast Brass	Aluminum w/Box FDWS-62	Cast Brass w/Box 3731
3743U-2	3763U-2	3789U-2	3789BU-2	3776U-2	3779U-2
3743U-3	3763U-3	3789U-3	3789BU-3	3776U-3	3779U-3
3743U-4	3763U-4	3789U-4	3789BU-4	3776U-4	3779U-4
3743U-5	3763U-5	3789U-5	3789BU-5	3776U-5	3779U-5
3743	3763	3789	3789B	3776	3779
3743U-1	3763U-1	3789U-1	3789BU-1	3776U-1	3779U-1
3753	3773	3809 <sup>1</sup>	3809B <sup>1</sup>	3796 <sup>2</sup>	3799 <sup>3</sup>
3744	3764	3790	3790B	3777	3780
3744	3764	3790	3790B	3777	3780
3754	3774	3810	3810B	3797	3800
3754	3774	3810	3810B	3797	3800

\*\* Receptacles come with the following boxes:

Material	Amperes	Box
Aluminum	10, 15 and 20 30	FSWS-62 FDWS-62
Brass	10, 15 and 20 30	3721 3731

For 20/30A thermoplastic devices, see DuraGard section.

Mating with DuraGard Line

- 20A devices will mate and lock across lines.
- 30A metal male devices cannot mate to DuraGard 30A female devices.

<sup>1</sup> Also in plastic. Use 3809P or 9F33U0

<sup>2</sup> Also in plastic. Use 3796PA – Aluminum back box (use 3797-P for brass)

<sup>3</sup> Also in plastic. Use 3799P (Brass J-Box) or 9B33U0F (w/o J-Box)

**For NEMA style (bladed) Convenience Receptacles, see page 124.**

RUSSELLSTOLL® DURAGARD®/FS/FD

# Russellstoll®

## FS/FD™ 10-30A Metallic Connections

Metallic Plugs, Connectors, Receptacles and Reverse Service Female Plugs/Male Inlets.  
10-30A, Maximum 600VAC/250VDC

### Dimensions

#### Plugs and Female Plugs

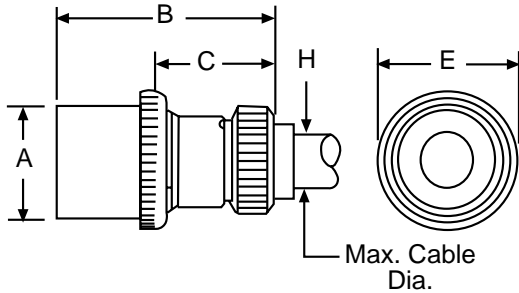

#### Connectors

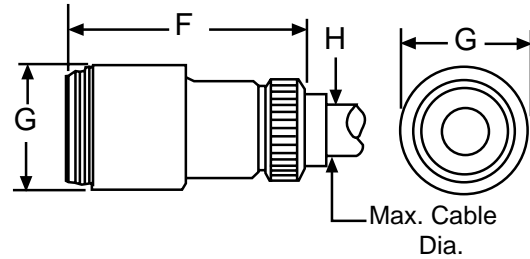

#### Plug, Female Plug and Connector Dimensions

Amps		A	B	C	E	F	G	H
10 Amp	Inches	1.75	3.62	2.25	2.00	4.00	1.87	0.75
	mm	45.65	92.07	57.15	50.80	101.60	47.62	19.050
15 Amp	Inches	1.75	3.62	2.25	2.00	4.00	1.87	0.75
	mm	45.65	92.07	57.15	50.80	101.60	47.62	19.050
20 Amp	Inches	1.75	3.62	2.25	2.00	4.00	1.87	0.75
	mm	45.65	92.07	57.15	50.80	101.60	47.62	19.050
30 Amp	Inches	1.87	3.75	2.25	2.25	4.25	2.25	1.12
	mm	47.62	95.25	57.15	57.15	107.95	57.15	28.57

### Receptacles and Male Receptacles

Standard Die Cast Aluminum Back Box  
(FSWS/FDWS)

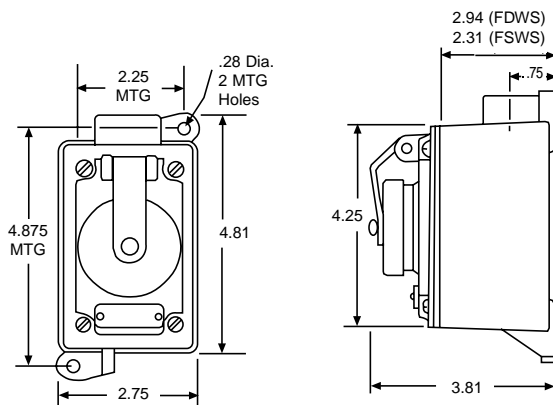

Cast Aluminum / Cast Brass Back Box  
(3701-3732 Series)

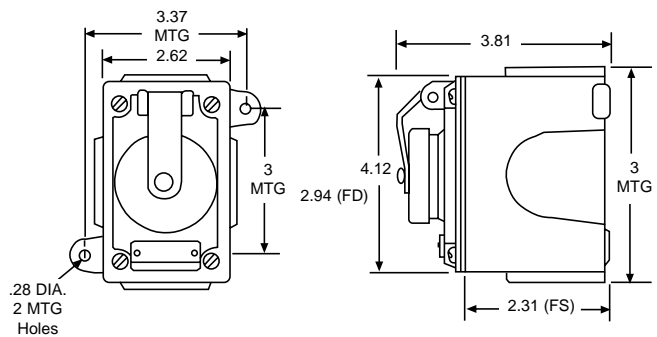

# Russellstoll®

## FS/FD™ 10-30A Metallic Connections





Metallic Plugs, Connectors, Receptacles and Reverse Service Female Plugs/Male Inlets.  
10-30A, Maximum 600VAC/250VDC

### Convenience Bladed NEMA Style Receptacles

Designed for **rugged service/commercial interface**, the receptacles below accommodate standard bladed convenience type plugs. They can be furnished in single

or tandem units and in combination with other Russellstoll FS/FD devices. Each **includes** a standard heavy duty cast back box.

### Ordering Information

	Weathertight (Flap Cap)			Watertight (Screw Cap)	
					
2P3W NEMA Rating*	Aluminum Duplex Receptacle	Brass Single Receptacle	Cast Aluminum (FDWS-62)* Duplex Receptacle	Aluminum Single Receptacle	Brass Single Receptacle
15 Amp 125V 5-15	<b>3998G**</b>	<b>3918G</b>	<b>3960G</b>	<b>3910G</b>	<b>3920G</b>
20 Amp 125V 5-20	<b>3998G-20**</b>	<b>3918G-20</b>	<b>3960G-20</b>	<b>3910G-20</b>	<b>3920G-20</b>

**Finish** – Cast aluminum, corrosion-resistant copper-free alloy, epoxy powder coat finish. Cast brass, natural finish.

**Gang Types** – Can be furnished in gang or tandem units in combination with other Russellstoll FS/FD devices. See Accessory reference charts on page 125 for more information.

**Outlet Boxes** – Unless otherwise specified, furnished with one 3/4" threaded conduit hole at B or D. Additional or larger conduit holes charged extra – see price list. Maximum hole one inch, four way. Specify size and location. Use symbols as indicated on diagram.

All the above receptacles accommodate standard convenience-type plugs.



\* Can be furnished with 250 Volt receptacles. Price on application.

\*\* The aluminum duplex cover assembly will accept many varied electrical and electronic devices. Please contact your local representative or Regional Sales Office with your requirements.

- ◆ Furnished with stamped Flap Cover made of heavy gage steel, zinc plated, with spring-hinged flap.

### Dimensions

#### Duplex Receptacles

