

B

Sta-Kon® - Termination products



—

B

Sta-Kon - Termination products

Table of contents

Section B

Overview	B4
Ring terminals	B8
Flag terminals	B23
Fork terminals	B24
Pin terminals	B30
Butt splices	B31
Butt splices and parallel splices	B33
Wire joints	B34
Heat-shrinkable terminals, splices and disconnects	B37
Disconnects and male tabs	B39
Luminaire disconnects	B46
Ferrules	B48
Installing kits	B53
Application tools	B56
Die selection chart	B68
Wire guide table	B71
Military standard cross reference	B75
Packaging cross reference	B76
Catamount® terminals	B80
Catamount terminal tools	B83
Insulated terminals	B84
Insulated disconnects	B91
Insulated butt splices	B94
Insulated wire joints	B95
Tools	B96

Overview

Experience the Sta-Kon advantage.



Sta-Kon developed the first tool-applied solderless terminals and connectors more than 70 years ago in response to industry awareness of the need for better performance of electrical systems.

Key features and benefits

- Metal insulation grip sleeve is included on all nylon terminal for strain relief
- Long barrel selectively annealed
- CSA Certified
- UL Listed unless otherwise specified

Deep internal serrations

After the insertion of a wire into the terminal's barrel, a deep, serrated interior ensures a large area of contact that lowers the resistance of a connection. With the mechanical force of the tool, the wire strands cold flow into the serrated interior. This guarantees electrical resistance lower than the wire to which it is applied. This feature also prevents pullout from vibration and mechanical strain. Deep internal serrations can be compared to the effective holding power of a well-treaded tire on a wet highway.

Funneled terminal barrel entry

This feature makes wire insertion faster and easier. A funneled barrel eliminates wire strand "hang up" upon insertion into the terminal's barrel. The loss of even a couple of wire strands can have negative results on electrical efficiency and resistance to mechanical strain.

Sta-Kon long barrel design

If lowering electrical resistance, preventing wire pullout, eliminating a "missed" crimp and having an insulator that stays on the barrel during installation are your goals, then you must design a terminal with a long barrel. This also provides the insulator with additional surface area, holding tight to the barrel. Most competitive barrel lengths range from 20–50% shorter than Sta-Kon terminals. The results are usually a stream of electrical failure, rework and added expense. Many competitive insulators come off during crimping due to a limited barrel length.

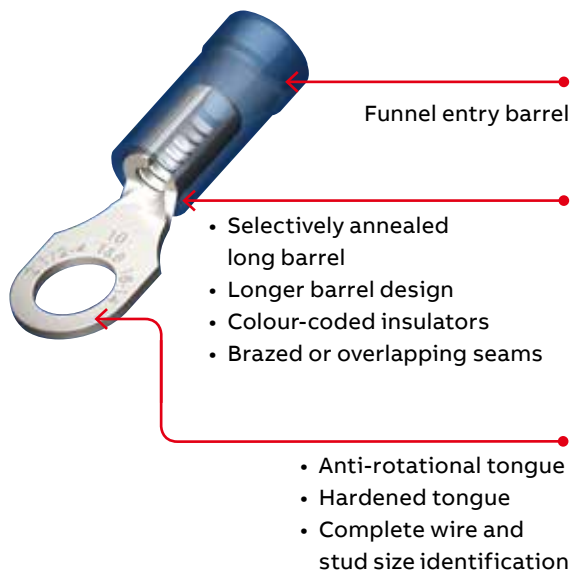

Note: Listed for solid wire up to #10 AWG, terminals only.

Why Sta-Kon terminals are better

Selective annealing

Because of the mechanical strength of copper, an installer can experience fatigue associated with repeated installations. For this reason, ABB puts our terminals through one more step called selective annealing. This process leaves the barrel soft enough to crimp and form around the wire. However, we “cold form” the tongue during the manufacturing process so it remains strong. This is done so the tongue can withstand repeated bends and bolt tightening strain common in most electrical installations. Many competitors attempt to accomplish similar goals by removing valuable material or using a softer copper that has lower conductivity. This increases electrical resistance as well as the odds for shorting and downtime.

Anti-rotational tongues

This is a unique feature to the ABB ring tongue terminal. This design prevents terminal shorting by keeping the terminal secure in the terminal block. The installer can place a greater number of terminals closer together without worry.

Proper identification

We identify all terminals with wire and stud sizes. These markings are clearly visible on the surface of the tongue, taking any guesswork out of replacing or reordering additional parts. Our superior bright plating also assists in visibility.

All Sta-Kon terminals are deburred and degreased

To ensure a Sta-Kon terminal is properly plated and insulated, all our parts are put through a process that cleans and smooths the terminal of any manufacturing residues, mainly grease, oils and sharp edges. Many competitive products do not put their product through such rigorous finishing.

Platings

Electro-plated tin is the standard. All others require minimum order quantities and are generally not stocked. Alternative platings as follows: gold, silver, tin-alloys, nickel, etc. The following finishes are available on most one-piece Sta-Kon terminals:

Finish	Suffix	Spec.	Temp. Rating
Gold plate	GP	MIL-G-45204 Type II, Grade B, C, D, Class O	260 °C
Nickel plate	NP	QQ-N-290 Class 2, Grade G	260 °C
Plain finish	PF	None	150 °C
Silver plate	SP	MIL-T-16366 Type I, or II, 400°F, 204°C	150 °C
Tin plate	TP	MIL-T-10727 Type I	150 °C

To order, add the indicated suffix to the regular catalogue number.

Underwriters Laboratories listing

Sta-Kon rings, forks, locking forks, two-way splices and disconnects are tested and listed to UL standards and all applicable products to CSA standards.

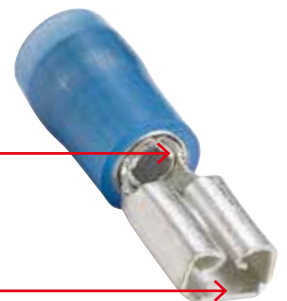

Deep internal serrations

- Flat bottom box
- Electro-tin plating
- Center reinforced spring detent for minimum insertion force
- Compound spring rails provide positive contact after repeated insertions

Overview

—
01 ERG4001

Sta-Kon ring, fork and locking fork

- Complete line of installing tools engineered to match tool with terminal
- First to gain military approval for pressure connections ... many styles available for military applications
- Sta-Kon products exceed test specification requirements of military, UL and CSA
- Fluoropolymer and nylon terminals provided with extra metal sleeve to grip insulation
- Vinyl-insulated and bare Sta-Kon terminals feature brazed seam wire barrels that can be crimped at any place on the barrel circumference
- Ring and fork terminals can be used with solid wire as follows:
 - Non-insulated: 22–8 AWG
 - Insulated: 22–10 AWG

Sta-Kon disconnects

- Internal barrel serrations and long barrel provide for maximum tensile strength
- Complete line of installing tools, engineered to match tool with terminal
- Funnel entry insulators allow for easier inserting of wire into barrel
- Colour-coded for easy installation

The Shure-Stake® tools are matched to terminals

The Shure-Stake mechanism prevents the dies from releasing the terminal until the proper compression has been completed. With this method, an operator achieves a reliable crimp everytime. ABB tooling techniques correctly match tools, wire size and terminal to produce optimum mechanical and electrical performance.





Sta-Kon RA, RB and RC insulated quick disconnect products are now UL Listed at 600 volts.

Sta-Kon technical data

Terminals and splices insulation rating	UL 94 flammability	Voltage	Temperature
Nylon	V-2	600	105 °C
Vinyl	V-0	600	105 °C
Tefzel®	V-0	600	105 °C
Disconnects (non-insulated)		300	105 °C

Tefzel is a registered trademark of DuPont.

The Sta-Kon terminals numbering system

Distributor package 100/50
Bulk OEM package 1000/500

Common to both packages

- Letter **A** denotes 22–18 AWG wire range = Red
- Letter **B** denotes 16–14 AWG wire range = Blue
- Letter **C** denotes 26–22 AWG, 12–10 AWG wire range = Yellow
- Letter **R** preceding the above letters indicates the terminal is insulated
- No letter **R**... no insulation... no exception!

Distributor packaged

Part numbers are very descriptive, indicating insulation and type, stud size, tongue style and the largest maximum wire that can be put inside.

- If the letter **R precedes** the number, the part is nylon insulated – RA18-6
- If the letter **R follows** the number, the part is vinyl insulated – 14RB-8

Example: 10RC-8F	
C	Indicates 12–10 AWG
10RC	Vinyl insulated
8	Indicates stud size
F	Means a fork tongue terminal
FL	Would indicate locking fork

Example: 2RA18X	
2	Indicates a 2-way or butt-style connector
X	Means expanded insulation

Ring terminals

Nylon-insulated ring terminals



- Complete line of installing tools engineered to match tool with terminal
- First to gain military approval for pressure connections... many styles available for military applications
- Sta-Kon products exceed test specification requirements of military, UL and CSA
- Include extra metal sleeve to grip insulation
- Vinyl insulated and bare Sta-Kon terminals feature brazed seam wire barrels that can be crimped at any place on the barrel circumference
- Can be installed with crimping tools having a single indentor or double indentor (recommended for solid wire)
- Serrated barrel increases grip on wire
- Wire range identification on the tongue of each terminal
- Constructed of electrolytic copper for high conductivity



Cat. no.	Wire Pkg. range qty. (AWG)	Max. ins. (in.)	Bolt hole (in.)	Rec. tool	Dimensions (in.)				Stock thick. (in.)
					A	B	C	M	
RZ22-2**	100 26-22	0.083	#2	ERG4006	0.57	0.14	0.13	0.49	0.02
RZ22-4**	100 26-22	0.083	#4	ERG4006	0.65	0.21	0.20	0.54	0.02
RZ22-6**	100 26-22	0.083	#6	ERG4006	0.65	0.21	0.20	0.54	0.02
RZ22-8**	100 26-22	0.083	#8	ERG4006	0.75	0.25	0.23	0.62	0.02
RZ22-10**	100 26-22	0.083	#10	ERG4006	0.75	0.25	0.23	0.62	0.02
RAX23*	1,000 26-24	0.125	#2	WT145A	0.66	0.14	0.14	0.59	0.02
RAX43*	1,000 26-24	0.125	#4	WT145A	0.74	0.20	0.19	0.64	0.02
RAX63*	1,000 26-24	0.125	#6	WT145A	0.84	0.25	0.22	0.72	0.02
RAX83*	1,000 26-24	0.125	#8	WT145A	0.84	0.25	0.22	0.72	0.02
RAX103*	1,000 26-24	0.125	#10	WT145A	0.84	0.25	0.24	0.72	0.02
RA18-4	100 22-16	0.136	#4	ERG4001	0.72	0.23	0.14	0.59	0.03
RA323	1,000 22-16	0.136	#4	ERG4001	0.72	0.23	0.14	0.59	0.03
RA333	1,000 22-16	0.136	#6	ERG4001	0.72	0.23	0.14	0.59	0.03
RA18-6	100 22-16	0.136	#6	ERG4001	0.86	0.26	0.25	0.71	0.03

* Not listed by UL or CSA

** CSA Certified only

Most standard bulk catalogue numbers can be put on mylar tape for reel feed applications (i.e. 12050 tool and application). Please add suffix M for mylar tape i.e. RA2573M.



Cat. no.	Wire Pkg. range qty. (AWG)	Max. ins. (in.)	Bolt hole (in.)	Rec. tool	Dimensions (in.)				Stock thick. (in.)
					A	B	C	M	
RA853	1,000 22-16	0.136	#6	WT145A	0.86	0.26	0.25	0.71	0.03
RA18-8	100 22-16	0.136	#8	WT145A	0.89	0.26	0.25	0.71	0.03
RA833	1,000 22-16	0.136	#8	WT145A	0.86	0.26	0.25	0.71	0.03
RA863	1,000 22-16	0.136	#8	WT145A	0.89	0.26	0.25	0.71	0.03
RA18-10	100 22-16	0.136	#10	WT145A	0.89	0.31	0.25	0.71	0.03
RA873	1,000 22-16	0.136	#10	WT145A	0.89	0.31	0.25	0.71	0.03
RA18-14	100 22-16	0.136	¼	WT145A	1.10	0.46	0.31	0.84	0.03
RA713	1,000 22-16	0.136	¼	WT145A	1.10	0.46	0.31	0.84	0.03
RA18-516	100 22-16	0.136	⅜	WT145A	1.10	0.46	0.31	0.84	0.03
RA723	1,000 22-16	0.136	⅜	ERG4001	1.10	0.46	0.31	0.84	0.03
RA18-38	100 22-16	0.136	⅝	ERG4001	1.20	0.53	0.35	0.87	0.03
RA733	1,000 22-16	0.136	⅝	ERG4001	1.20	0.53	0.35	0.87	0.03
RA18-12	100 22-16	0.136	½	ERG4001	1.30	0.72	0.50	0.92	0.03
RA753	1,000 22-16	0.136	½	ERG4001	1.30	0.72	0.50	0.92	0.03

Diagram

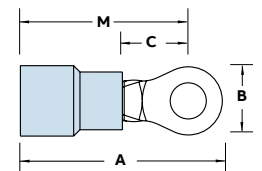

Ring terminals

Nylon-insulated ring terminals



Cat. no.	Pkg. qty.	Wire range (AWG)	Max. ins. (in.)	Bolt hole (in.)	Rec. tool	Dimensions (in.)				Stock thick. (in.)
						A	B	C	M	
RB14-4	100	18-14	0.162	#4	ERG4001	0.72	0.26	0.14	0.59	0.03
RB1323	1,000	18-14	0.162	#4	ERG4001	0.72	0.26	0.14	0.59	0.03
RB14-6	100	18-14	0.162	#6	ERG4001	0.89	0.31	0.25	0.71	0.03
RB853	1,000	18-14	0.162	#6	ERG4001	0.89	0.31	0.25	0.71	0.03
RB1333	1,000	18-14	0.162	#6	ERG4001	0.74	0.26	0.14	0.59	0.03
RB14-8	100	18-14	0.162	#8	ERG4001	0.89	0.31	0.25	0.71	0.03
RB863	1,000	18-14	0.162	#8	ERG4001	0.89	0.31	0.25	0.71	0.03
RB14-10	100	18-14	0.162	#10	ERG4001	0.89	0.31	0.25	0.71	0.03
RB873	1,000	18-14	0.162	#10	ERG4001	0.89	0.31	0.25	0.71	0.03
RB14-14	100	18-14	0.162	¼	ERG4001	1.08	0.47	0.31	0.81	0.03
RB713	1,000	18-14	0.162	¼	ERG4001	1.08	0.47	0.31	0.81	0.03
RB14-516	100	18-14	0.162	⅜	ERG4001	1.08	0.47	0.31	0.84	0.03
RB723	1,000	18-14	0.162	⅜	ERG4001	1.08	0.47	0.31	0.84	0.03
RB14-38	100	18-14	0.162	⅝	ERG4001	1.17	0.53	0.35	0.87	0.03
RB733	1,000	18-14	0.162	⅝	ERG4001	1.17	0.53	0.35	0.87	0.03
RB14-12	100	18-14	0.162	½	ERG4001	1.25	0.72	0.50	0.90	0.03
RB753	1,000	18-14	0.162	½	ERG4001	1.25	0.72	0.50	0.90	0.03



Cat. no.	Pkg. qty.	Wire range (AWG)	Max. ins. (in.)	Bolt hole (in.)	Rec. tool	Dimensions (in.)				Stock thick. (in.)
						A	B	C	M	
RC10-6	50	12-10	0.210	#6	ERG4001	1.00	0.37	0.27	0.81	0.04
RC333	500	12-10	0.210	#6	ERG4001	1.00	0.37	0.27	0.81	0.04
RC10-8	50	12-10	0.210	#8	ERG4001	1.00	0.37	0.27	0.81	0.04
RC863	500	12-10	0.210	#8	ERG4001	1.00	0.37	0.27	0.81	0.04
RC10-10	50	12-10	0.210	#10	ERG4001	1.00	0.37	0.27	0.81	0.04
RC363	500	12-10	0.210	#10	ERG4001	1.00	0.37	0.27	0.81	0.04
RC10-14	50	12-10	0.210	¼	ERG4001	1.12	0.53	0.32	0.86	0.04
RC713	500	12-10	0.210	¼	ERG4001	1.12	0.53	0.32	0.86	0.04
RC10-516	50	12-10	0.210	⅜	ERG4001	1.21	0.53	0.31	0.94	0.04
RC703	500	12-10	0.210	⅜	ERG4001	1.21	0.53	0.31	0.94	0.04
RC10-38	50	12-10	0.210	⅝	ERG4001	1.27	0.59	0.35	0.98	0.04
RC733	500	12-10	0.210	⅝	ERG4001	1.27	0.59	0.35	0.98	0.04
RC10-12	50	12-10	0.210	½	ERG4001	1.37	0.72	0.52	1.02	0.04
RC753	500	12-10	0.210	½	ERG4001	1.37	0.72	0.52	1.02	0.04

Diagram

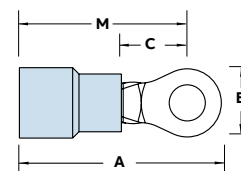

Ring terminals

Nylon-insulated ring terminals — expanded entry



Cat. no.	Pkg. qty.	Wire range AWG	Max. ins. (in.)	Bolt hole (in.)	Rec. tool	Dimensions (in.)				Stock thick. (in.)
						A	B	C	M	
RB14-4X	100	18-14	0.190	#4	ERG4001	0.80	0.26	0.14	0.67	0.03
RB14-6X	100	18-14	0.190	#6	ERG4001	0.95	0.31	0.25	0.79	0.03
RB854	1,000	18-14	0.190	#6	ERG4001	0.95	0.31	0.25	0.79	0.03
RB14-8X	100	18-14	0.190	#8	ERG4001	0.95	0.31	0.25	0.79	0.03
RB864	1,000	18-14	0.190	#8	ERG4001	0.95	0.31	0.25	0.79	0.03
RB14-10X	100	18-14	0.190	#10	ERG4001	0.95	0.31	0.25	0.79	0.03
RB874	1,000	18-14	0.190	#10	ERG4001	0.95	0.31	0.25	0.79	0.03
RB14-14X	100	18-14	0.190	¼	ERG4001	1.16	0.47	0.31	0.92	0.03
RB714	1,000	18-14	0.190	¼	ERG4001	1.16	0.47	0.31	0.92	0.03
RB14-516X	100	18-14	0.190	5/16	ERG4001	1.16	0.47	0.31	0.92	0.03
RB724	1,000	18-14	0.190	5/16	ERG4001	1.16	0.47	0.31	0.92	0.03
RB14-38X	100	18-14	0.190	¾	ERG4001	1.25	0.53	0.42	0.95	0.03
RB734	1,000	18-14	0.190	¾	ERG4001	1.25	0.53	0.42	0.95	0.03



Cat. no.	Pkg. qty.	Wire range AWG	Max. ins. (in.)	Bolt hole (in.)	Rec. tool	Dimensions (in.)				Stock thick. (in.)
						A	B	C	M	
RC10-6X	50	12-10	0.250	#6	ERG4001	1.10	0.37	0.27	0.91	0.04
RC334	500	12-10	0.250	#6	ERG4001	1.10	0.37	0.27	0.91	0.04
RC10-8X	50	12-10	0.250	#8	ERG4001	1.10	0.37	0.27	0.91	0.04
RC864	500	12-10	0.250	#8	ERG4001	1.10	0.37	0.27	0.91	0.04
RC10-10X	50	12-10	0.250	#10	ERG4001	1.10	0.37	0.27	0.91	0.04
RC364	500	12-10	0.250	#10	ERG4001	1.10	0.37	0.27	0.91	0.04
RC10-14X	50	12-10	0.250	¼	ERG4001	1.22	0.53	0.32	0.96	0.04
RC714	500	12-10	0.250	¼	ERG4001	1.22	0.53	0.32	0.96	0.04
RC10-516X	50	12-10	0.250	5/16	ERG4001	1.32	0.53	0.31	1.05	0.04
RC704	500	12-10	0.250	5/16	ERG4001	1.32	0.53	0.31	1.05	0.04
RC10-38X	50	12-10	0.250	¾	ERG4001	1.38	0.59	0.48	1.09	0.04
RC734	500	12-10	0.250	¾	ERG4001	1.38	0.59	0.48	1.09	0.04
RC10-12X	50	12-10	0.250	½	ERG4001	1.48	0.72	0.52	1.13	0.04

Diagram

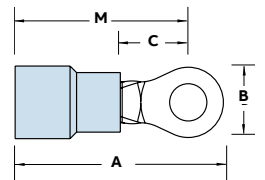

Ring terminals

Nylon-insulated large ring terminals



Cat. no.	Pkg. qty.	Wire range (AWG)	Max. ins. (in.)	Bolt hole (in.)	Rec. tool	Dimensions (in.)				Stock thick. (in.)
						A	B	C	M	
Flex class 41/24										
RD167	200	8	0.340	#8	ERG4007	1.48	0.42	0.28	1.29	0.04
RD8-10	25	8	0.340	#10	ERG4007	1.48	0.42	0.28	1.29	0.04
RD367	200	8	0.340	#10	ERG4007	1.48	0.42	0.28	1.29	0.04
RD8-14	25	8	0.340	¼	ERG4007	1.54	0.46	0.36	1.32	0.04
RD717	200	8	0.340	¼	ERG4007	1.54	0.46	0.36	1.32	0.04
RD8-516	25	8	0.340	⅝	ERG4007	1.63	0.57	0.36	1.35	0.04
RD727	200	8	0.340	⅝	ERG4007	1.63	0.57	0.36	1.35	0.04
RD8-38	25	8	0.340	¾	ERG4007	1.63	0.57	0.36	1.35	0.04
RD737	200	8	0.340	¾	ERG4007	1.63	0.57	0.36	1.35	0.04
RD8-12*	25	8	0.310	½	TBM6S	1.79	0.82	0.55	1.39	0.04
RD757*	200	8	0.310	½	TBM6S	1.79	0.82	0.55	1.39	0.04
RD10161	200	8AN	0.270	#8	ERG4007	1.40	0.41	0.24	1.20	0.04
RD10361	200	8AN	0.270	#10	ERG4007	1.40	0.41	0.24	1.20	0.04
RD10711	200	8AN	0.270	¼	ERG4007	1.45	0.45	0.27	1.22	0.04
RD10721	200	8AN	0.270	⅝	ERG4007	1.53	0.56	0.34	1.25	0.04
RD10731	200	8AN	0.270	¾	ERG4007	1.53	0.56	0.34	1.25	0.04
Flex class 63/24										
RE6-10	20	6	0.420	#10	ERG4007	1.65	0.49	0.28	1.40	0.04
RE267	200	6	0.420	#10	ERG4007	1.65	0.49	0.28	1.40	0.04
RE6-14	20	6	0.420	¼	ERG4007	1.65	0.49	0.28	1.40	0.04
RE717	200	6	0.420	¼	ERG4007	1.65	0.49	0.28	1.40	0.04
RE6-516	20	6	0.420	⅝	ERG4007	1.76	0.61	0.34	1.47	0.04
RE727	200	6	0.420	⅝	ERG4007	1.76	0.61	0.34	1.47	0.04
RE6-38	20	6	0.420	¾	ERG4007	1.76	0.61	0.34	1.47	0.04
RE737	200	6	0.420	¾	ERG4007	1.76	0.61	0.34	1.47	0.04
RE6-12*	20	6	0.395	½	TBM6S	1.83	0.82	0.55	1.43	0.04
RE757*	200	6	0.395	½	TBM6S	1.83	0.82	0.55	1.43	0.04
RE10261	200	6AN	0.315	#10	ERG4007	1.55	0.49	0.24	1.31	0.04
RE10711	200	6AN	0.315	¼	ERG4007	1.55	0.49	0.27	1.31	0.04
RE10721	200	6AN	0.315	⅝	ERG4007	1.70	0.60	0.34	1.40	0.04
RE10731	200	6AN	0.315	¾	ERG4007	1.70	0.60	0.34	1.40	0.04



Cat. no.	Pkg. qty.	Wire range AWG	Max. ins. (in.)	Bolt hole (in.)	Rec. tool	Dimensions (in.)				Stock thick. (in.)
						A	B	C	M	
Flex Class 105/24										
RF4-10	15	4	0.510	#10	TBM6S	1.76	0.56	0.36	1.49	0.04
RF267	100	4	0.510	#10	TBM6S	1.76	0.56	0.36	1.49	0.04
RF4-14	15	4	0.510	¼	TBM6S	1.76	0.56	0.36	1.49	0.04
RF717	100	4	0.510	¼	TBM6S	1.76	0.56	0.36	1.49	0.04
RF4-516	15	4	0.510	⅝	TBM6S	1.84	0.62	0.35	1.53	0.04
RF727	100	4	0.510	⅝	TBM6S	1.84	0.62	0.35	1.53	0.04
RF4-38	15	4	0.510	¾	TBM6S	1.84	0.62	0.35	1.53	0.04
RF737	100	4	0.510	¾	TBM6S	1.84	0.62	0.35	1.53	0.04
RF757*	100	4	0.500	½	TBM6S	1.90	0.82	0.55	1.49	0.04
RF10261	100	4AN	0.380	#10	TBM6S	1.78	0.55	0.30	1.51	0.04
RF10711	100	4AN	0.380	¼	TBM6S	1.78	0.55	0.30	1.51	0.04
RF10721	100	4AN	0.380	⅝	TBM6S	1.80	0.62	0.34	1.49	0.04
RF10731	100	4AN	0.380	¾	TBM6S	1.80	0.62	0.34	1.49	0.04

*Brazead seam
AN=Aircraft wire

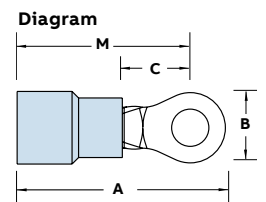

Ring terminals

Nylon-insulated large ring terminals (cont.)



Cat. no.	Pkg. qty.	Wire range (AWG)	Max. ins. (in.)	Bolt hole (in.)	Rec. tool	Dimensions (in.)				Stock thick. (in.)
						A	B	C	M	
RG2-10	10	2	0.588	#10	TBM6S	2.15	0.69	0.40	1.83	0.05
RG267	50	2	0.588	#10	TBM6S	2.15	0.69	0.40	1.83	0.05
RG2-14	10	2	0.588	¼	TBM6S	2.15	0.69	0.40	1.83	0.05
RG717	50	2	0.588	¼	TBM6S	2.15	0.69	0.40	1.83	0.05
RG2-516	10	2	0.588	⅝	TBM6S	2.15	0.69	0.40	1.83	0.05
RG727	50	2	0.588	⅝	TBM6S	2.15	0.69	0.40	1.83	0.05
RG2-38	10	2	0.588	¾	TBM6S	2.15	0.69	0.40	1.83	0.05
RG737	50	2	0.588	¾	TBM6S	2.15	0.69	0.40	1.83	0.05
RG2-12	10	2	0.588	½	TBM6S	2.35	0.80	0.49	1.93	0.05
RG757	50	2	0.588	½	TBM6S	2.35	0.80	0.49	1.93	0.05
RG9711	50	2AN	0.453	¼	TBM6S	2.07	0.69	0.40	1.74	0.05
RG9731	50	2AN	0.453	⅜	TBM6S	2.07	0.69	0.40	1.74	0.05
RG9751	50	2AN	0.453	½	TBM6S	2.26	0.80	0.49	1.84	0.05
RH717	50	1/0	0.629	¼	TBM6S	2.14	0.77	0.43	1.81	0.05
RH727	50	1/0	0.629	⅝	TBM6S	2.14	0.77	0.43	1.81	0.05
RH737	50	1/0	0.629	¾	TBM6S	2.14	0.77	0.43	1.81	0.05
RH757	50	1/0	0.629	½	TBM6S	2.34	0.77	0.54	1.90	0.05
RH9711	50	1AN	0.500	¼	TBM6S	2.14	0.77	0.44	1.81	0.05
RH9731	50	1AN	0.500	⅜	TBM6S	2.14	0.77	0.44	1.81	0.05
RH9751	50	1AN	0.500	½	TBM6S	2.34	0.77	0.54	1.90	0.05

Cat. no.	Pkg. qty.	Wire range AWG	Max. ins. (in.)	Bolt hole (in.)	Rec. tool	Dimensions (in.)				Stock thick. (in.)
						A	B	C	M	
RJ717	100	2/0	0.675	¼	TBM6S	2.34	0.83	0.46	1.96	0.06
RJ727	100	2/0	0.675	⅝	TBM6S	2.34	0.83	0.46	1.96	0.06
RJ737	100	2/0	0.675	¾	TBM6S	2.34	0.83	0.46	1.96	0.06
RJ757	100	2/0	0.675	½	TBM6S	2.48	0.89	0.54	2.03	0.06
RJ9711	50	1/0AN	0.550	¼	TBM6S	2.35	0.83	0.46	1.97	0.06
RJ9731	50	1/0AN	0.550	⅜	TBM6S	2.35	0.83	0.46	1.97	0.06
RJ9751	50	1/0AN	0.550	½	TBM6S	2.49	0.89	0.55	2.04	0.06
RK717	25	3/0	0.765	¼	TBM6S	2.60	0.93	0.54	2.21	0.06
RK727	25	3/0	0.765	⅝	TBM6S	2.60	0.93	0.54	2.21	0.06
RK737	25	3/0	0.765	¾	TBM6S	2.60	0.93	0.54	2.21	0.06
RK9731	100	2/0AN	0.610	⅜	TBM6S	2.52	0.93	0.55	2.14	0.06
RK9751	100	2/0AN	0.610	½	TBM6S	2.60	0.93	0.55	2.15	0.06
RL737	25	4/0	0.785	⅜	TBM6S	2.83	1.04	0.57	2.35	0.07
RL757	25	4/0	0.785	½	TBM6S	2.83	1.04	0.57	2.35	0.07
RL9731	25	3/0AN	0.680	⅜	TBM6S	2.83	1.04	0.57	2.36	0.07
RL9751	25	3/0AN	0.680	½	TBM6S	2.83	1.04	0.57	2.36	0.07
RM737	20	250	0.868	⅜	TBM6S	3.00	1.13	0.65	2.51	0.07
RM747	20	250	0.868	⅝	TBM6S	3.00	1.13	0.65	2.51	0.07
RM757	20	250	0.868	½	TBM6S	3.00	1.13	0.65	2.51	0.07
RM9731	20	4/0AN	0.750	⅜	TBM6S	3.00	1.13	0.66	2.51	0.07
RM9751	20	4/0AN	0.750	½	TBM6S	3.00	1.13	0.66	2.51	0.07

Diagram

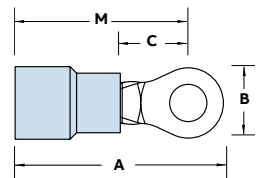

Ring terminals

Vinyl-insulated ring terminals



Extra-length PVC sleeve offers extra protection.



Cat. no.	Pkg. qty.	Wire range (AWG)	Max. ins. (in.)	Bolt hole (in.)	Rec. tool	Dimensions (in.)				Stock thick. (in.)
						A	B	C	M	
18RA-4	100	22-16	0.150	#4	ERG4001	0.97	0.31	0.27	0.81	0.03
RA77	1,000	22-16	0.150	#4	ERG4001	0.97	0.31	0.27	0.81	0.03
18RA-6	100	22-16	0.150	#6	ERG4001	0.94	0.25	0.27	0.81	0.03
RA857	1,000	22-16	0.150	#6	ERG4001	0.94	0.25	0.27	0.81	0.03
18RA-8	100	22-16	0.150	#8	ERG4001	0.97	0.31	0.27	0.81	0.03
RA867	1,000	22-16	0.150	#8	ERG4001	0.97	0.31	0.27	0.81	0.03
18RA-10	100	22-16	0.150	#10	ERG4001	0.97	0.31	0.27	0.81	0.03
RA877	1,000	22-16	0.150	#10	ERG4001	0.97	0.31	0.27	0.81	0.03
18RA-14	100	22-16	0.150	3/4	ERG4001	1.13	0.50	0.37	0.88	0.03
RA717	1,000	22-16	0.150	3/4	ERG4001	1.13	0.50	0.37	0.88	0.03
18RA-516	100	22-16	0.150	5/16	ERG4001	1.13	0.50	0.37	0.88	0.03
RA727	1,000	22-16	0.150	5/16	ERG4001	1.13	0.50	0.37	0.88	0.03
18RA-38	100	22-16	0.150	3/8	ERG4001	1.24	0.54	0.37	0.91	0.03
RA737	1,000	22-16	0.150	3/8	ERG4001	1.24	0.54	0.37	0.91	0.03
14RB-4	100	18-14	0.170	#4	ERG4001	0.94	0.25	0.27	0.81	0.03
RB1327	1,000	18-14	0.170	#4	ERG4001	0.94	0.25	0.27	0.81	0.03
14RB-6	100	18-14	0.170	#6	ERG4001	0.97	0.31	0.27	0.81	0.03
RB857	1,000	18-14	0.170	#6	ERG4001	0.97	0.31	0.27	0.81	0.03
14RB-8	100	18-14	0.170	#8	ERG4001	0.97	0.31	0.27	0.81	0.03
RB867	1,000	18-14	0.170	#8	ERG4001	0.97	0.31	0.27	0.81	0.03
14RB-10	100	18-14	0.170	#10	ERG4001	0.97	0.31	0.27	0.81	0.03
RB877	1,000	18-14	0.170	#10	ERG4001	0.97	0.31	0.27	0.81	0.03
14RB-14	100	18-14	0.170	3/4	ERG4001	1.14	0.50	0.38	0.89	0.03
RB717	1,000	18-14	0.170	3/4	ERG4001	1.14	0.50	0.38	0.89	0.03
14RB-516	100	18-14	0.170	5/16	ERG4001	1.15	0.50	0.38	0.89	0.03
RB727	1,000	18-14	0.170	5/16	ERG4001	1.15	0.50	0.38	0.89	0.03
14RB-38	100	18-14	0.170	3/8	ERG4001	1.16	0.54	0.38	0.91	0.03
RB737	1,000	18-14	0.170	3/8	ERG4001	1.16	0.54	0.38	0.91	0.03

Cat. no.	Pkg. qty.	Wire range (AWG)	Max. ins. (in.)	Bolt hole (in.)	Rec. tool	Dimensions (in.)				Stock thick. (in.)
						A	B	C	M	
10RC-6	50	12-10	0.210	#6	ERG4001	1.06	0.31	0.27	0.90	0.04
RC337	500	12-10	0.210	#6	ERG4001	1.06	0.31	0.27	0.90	0.04
10RC-8	50	12-10	0.210	#8	ERG4001	1.06	0.31	0.27	0.90	0.04
RC777	500	12-10	0.210	#8	ERG4001	1.06	0.31	0.27	0.90	0.04
10RC-10	50	12-10	0.210	#10	ERG4001	1.06	0.31	0.27	0.90	0.04
RC367	500	12-10	0.210	#10	ERG4001	1.06	0.31	0.27	0.90	0.04
10RC-14	50	12-10	0.210	3/4	ERG4001	1.16	0.50	0.27	0.90	0.04
RC717	500	12-10	0.210	3/4	ERG4001	1.16	0.50	0.27	0.90	0.04
10RC-516	50	12-10	0.210	5/16	ERG4001	1.17	0.50	0.37	0.92	0.04
RC707	500	12-10	0.210	5/16	ERG4001	1.17	0.50	0.37	0.92	0.04
10RC-38	50	12-10	0.210	3/8	ERG4001	1.29	0.59	0.44	0.99	0.04
RC737	500	12-10	0.210	3/8	ERG4001	1.29	0.59	0.44	0.99	0.04

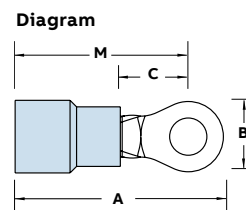

Ring terminals

Vinyl-insulated expanded insulation and large ring terminals



A wider wire entry for heavy-wall insulation



Vinyl-insulated ring terminals — Expanded insulation



Cat. no.	Pkg. qty.	Wire range (AWG)	Max. ins. (in.)	Bolt hole (in.)	Rec. tool	Dimensions (in.)				Stock thick. (in.)
						A	B	C	M	
18RA-4X	100	22-16	0.170	#4	ERG4001	0.97	0.31	0.27	0.81	0.03
18RA-6X	100	22-16	0.170	#6	ERG4001	0.97	0.31	0.27	0.81	0.03
18RA-8X	100	22-16	0.170	#8	ERG4001	0.97	0.31	0.27	0.81	0.03
18RA-38X	100	22-16	0.170	3/8	ERG4001	1.15	0.54	0.35	0.90	0.03
RA857-170	1,000	22-16	0.170	#6	ERG4001	0.97	0.31	0.27	0.81	0.03
RA867-170	1,000	22-16	0.170	#8	ERG4001	0.97	0.31	0.27	0.81	0.03
18RA-10X	1,000	22-16	0.170	#10	ERG4001	0.97	0.31	0.27	0.81	0.03
RA877-170	1,000	22-16	0.170	#10	ERG4001	0.97	0.31	0.27	0.81	0.03
18RA-14X	100	22-16	0.170	1/4	ERG4001	1.13	0.50	0.37	0.88	0.03
RA727-170	1,000	22-16	0.170	5/16	ERG4001	1.13	0.50	0.37	0.88	0.03
14RB-4X	100	18-14	0.200	#4	ERG4001	0.94	0.25	0.27	0.81	0.03
14RB-6X	100	18-14	0.200	#6	ERG4001	0.97	0.31	0.27	0.81	0.03
RB857-200	1,000	18-14	0.200	#6	ERG4001	0.97	0.31	0.27	0.81	0.03
14RB-8X	100	18-14	0.200	#8	ERG4001	0.97	0.31	0.27	0.81	0.03
RB867-200	1,000	18-14	0.200	#8	ERG4001	0.97	0.31	0.27	0.81	0.03
14RB-10X	100	18-14	0.200	#10	ERG4001	0.97	0.31	0.27	0.81	0.03
RB877-200	1,000	18-14	0.200	#10	ERG4001	0.97	0.31	0.27	0.81	0.03
14RB-14X	100	18-14	0.200	1/4	ERG4001	1.14	0.50	0.38	0.89	0.03
RB717-200	1,000	18-14	0.200	1/4	ERG4001	1.14	0.50	0.38	0.89	0.03
14RB-516X	100	18-14	0.200	5/16	ERG4001	1.15	0.50	0.38	0.89	0.03
14RB-38X	100	18-14	0.200	3/8	ERG4001	1.16	0.54	0.35	0.91	0.03
10RC-6X	50	12-10	0.250	#6	ERG4001	1.06	0.31	0.27	0.90	0.04
RC337-250	500	12-10	0.250	#6	ERG4001	1.06	0.31	0.27	0.90	0.04
10RC-8X	50	12-10	0.250	#8	ERG4001	1.06	0.31	0.27	0.90	0.04
RC777-250	500	12-10	0.250	#8	ERG4001	1.06	0.31	0.27	0.90	0.04
10RC-10X	50	12-10	0.250	#10	ERG4001	1.06	0.31	0.27	0.90	0.04
RC367-250	500	12-10	0.250	#10	ERG4001	1.06	0.31	0.27	0.90	0.04
10RC-14X	50	12-10	0.250	1/4	ERG4001	1.16	0.50	0.27	0.90	0.04
RC717-250	500	12-10	0.250	1/4	ERG4001	1.16	0.50	0.27	0.90	0.04
10RC-516X	50	12-10	0.250	5/16	ERG4001	1.17	0.50	0.37	0.92	0.04
10RC-38X	50	12-10	0.250	3/8	ERG4001	1.29	0.59	0.44	0.99	0.04
RC737-250	500	12-10	0.250	3/8	ERG4001	1.29	0.59	0.44	0.99	0.04

Vinyl-insulated large ring terminals



Cat. no.	Wire range (AWG)	Max. ins. (in.)	Bolt hole (in.)	Rec. tool	Dimensions (in.)				Stock thick. (in.)
					A	B	C	M	
RDV167	8	0.340	#8	ERG4007	1.36	0.42	0.28	1.17	0.04
RDV367	8	0.340	#10	ERG4007	1.36	0.42	0.28	1.17	0.04
RDV717	8	0.340	1/4	ERG4007	1.42	0.46	0.36	1.20	0.04
RDV727	8	0.340	5/16	ERG4007	1.51	0.57	0.36	1.23	0.04
RDV737	8	0.340	3/8	ERG4007	1.51	0.57	0.36	1.23	0.04
RDV757*	8	0.340	1/2	TBM6S	1.67	0.82	0.55	1.27	0.04
REV267	6	0.390	#10	ERG4007	1.48	0.45	0.28	1.23	0.04
REV717	6	0.390	1/4	ERG4007	1.48	0.49	0.28	1.23	0.04
REV727	6	0.390	5/16	ERG4007	1.59	0.61	0.34	1.30	0.04
REV737	6	0.390	3/8	ERG4007	1.59	0.61	0.34	1.30	0.04
REV757*	6	0.390	1/2	TBM6S	1.66	0.82	0.55	1.26	0.04

*Brazead seam

Diagram

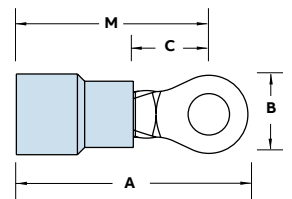

Ring terminals

Non-insulated ring terminals



Constructed of electrolytic copper for high conductivity.



Cat. no.	Pkg. qty.	Wire range (AWG)	Bolt hole (in.)	Rec. tool	Dimensions (in.)				Stock thick. (in.)
					A	B	C	M	
A18-4	100	22-16	#4	ERG4002	0.75	0.31	0.27	0.59	0.03
A18-6	100	22-16	#6		0.72	0.25	0.27	0.59	0.03
A85	1,000	22-16	#6		0.72	0.25	0.27	0.59	0.03
A18-8	100	22-16	#8		0.75	0.31	0.27	0.59	0.03
A86	1,000	22-16	#8		0.75	0.31	0.27	0.59	0.03
A18-10	100	22-16	#10		0.75	0.31	0.27	0.59	0.03
A87	1,000	22-16	#10		0.75	0.31	0.27	0.59	0.03
A18-14	100	22-16	¼		0.92	0.50	0.37	0.67	0.03
A71	1,000	22-16	¼		0.92	0.50	0.37	0.67	0.03
A18-516	100	22-16	⅜		0.92	0.50	0.37	0.67	0.03
A72	1,000	22-16	⅜		0.92	0.50	0.37	0.67	0.03
A18-38	100	22-16	⅝		0.99	0.54	0.35	0.67	0.03
A73	1,000	22-16	⅝		0.99	0.54	0.35	0.67	0.03
A18-12	100	22-16	½		1.06	0.72	0.38	0.70	0.03
A75	1,000	22-16	½		1.06	0.72	0.38	0.70	0.03
B14-4	100	18-14	#4	ERG4002	0.72	0.25	0.27	0.59	0.03
B132	1,000	18-14	#4	ERG4005	0.72	0.25	0.27	0.59	0.03
B14-6	100	18-14	#6		0.72	0.25	0.27	0.59	0.03
B133	1,000	18-14	#6		0.72	0.25	0.27	0.59	0.03
B14-8	100	18-14	#8		0.75	0.31	0.27	0.59	0.03
B86	1,000	18-14	#8		0.75	0.31	0.27	0.59	0.03
B14-10	100	18-14	#10		0.75	0.31	0.27	0.59	0.03
B87	1,000	18-14	#10		0.75	0.31	0.27	0.59	0.03
B14-14	100	18-14	¼		0.93	0.50	0.38	0.68	0.03



Cat. no.	Pkg. qty.	Wire range (AWG)	Bolt hole (in.)	Rec. tool	Dimensions (in.)				Stock thick. (in.)
					A	B	C	M	
B71	1,000	18-14	¼	ERG4002	0.93	0.50	0.38	0.68	0.03
B14-516	100	18-14	⅜	ERG4005	0.93	0.50	0.38	0.68	0.03
B72	1,000	18-14	⅜		0.93	0.50	0.38	0.68	0.03
B14-38	100	18-14	⅝		0.96	0.54	0.35	0.68	0.03
B73	1,000	18-14	⅝		0.96	0.54	0.35	0.68	0.03
B14-12	100	18-14	½		1.06	0.72	0.38	0.70	0.03
B75-TB	1,000	18-14	½		1.06	0.72	0.38	0.70	0.03
B85	1,000	18-14	#6		0.75	0.31	0.27	0.59	0.03
B134	1,000	18-14	#8		0.72	0.25	0.27	0.59	0.03
C10-6-SK	50	12-10	#6	ERG4002	0.82	0.31	0.27	0.66	0.04
C33-TB	500	12-10	#6	ERG4005	0.82	0.31	0.27	0.66	0.04
C10-8-SK	50	12-10	#8		0.82	0.31	0.27	0.66	0.04
C77	500	12-10	#8		0.82	0.31	0.27	0.66	0.04
C10-10	50	12-10	#10		0.85	0.38	0.27	0.66	0.04
C26	500	12-10	#10		0.85	0.38	0.27	0.66	0.04
C36	500	12-10	#10		0.82	0.31	0.27	0.66	0.04
C10-14	50	12-10	¼		0.91	0.50	0.27	0.66	0.04
C71	500	12-10	¼		0.91	0.50	0.27	0.66	0.04
C10-516	50	12-10	⅜		0.98	0.50	0.38	0.73	0.04
C70	500	12-10	⅜		0.98	0.50	0.38	0.73	0.04
C72	500	12-10	⅜		1.10	0.59	0.45	0.80	0.04
C10-38	50	12-10	⅝		1.10	0.59	0.45	0.80	0.04
C73	500	12-10	⅝		1.10	0.59	0.45	0.80	0.04
C10-12	50	12-10	½		1.21	0.72	0.38	0.84	0.04
C75	500	12-10	½		1.21	0.72	0.38	0.84	0.04

Diagram

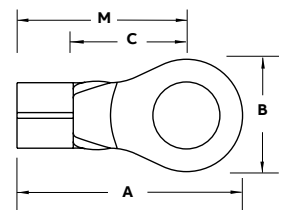

Ring terminals

Non-insulated large ring terminals — Brazed seam



Cat. no.	Pkg. qty.	Wire range (AWG)	Bolt hole (in.)	Rec. tool	Dimensions (in.)				Stock thick. (in.)
					A	B	C	M	
D8-10	25	8	#10	TBM6S	1.09	0.42	0.34	0.90	0.06
D36	200	8	#10	TBM6S	1.09	0.42	0.34	0.90	0.06
D26	200	8	#10	TBM6S	1.13	0.48	0.36	0.90	0.06
D8-14-SK	25	8	¼	TBM6S	1.13	0.48	0.36	0.90	0.06
D71	200	8	¼	TBM6S	1.13	0.48	0.36	0.90	0.06
D8-516	25	8	⅝	TBM6S	1.32	0.59	0.49	1.03	0.06
D72	200	8	⅝	TBM6S	1.32	0.59	0.49	1.03	0.06
D8-38	25	8	⅜	TBM6S	1.32	0.59	0.49	1.03	0.06
D73	200	8	⅜	TBM6S	1.32	0.59	0.49	1.03	0.06
D8-12	25	8	½	TBM6S	1.49	0.82	0.55	1.09	0.06
D75	200	8	½	TBM6S	1.49	0.82	0.55	1.09	0.06
E6-10	20	6	#10	TBM6S	1.13	0.48	0.36	0.90	0.06
E26	200	6	#10	TBM6S	1.13	0.48	0.36	0.90	0.06
E6-14	20	6	¼	TBM6S	1.13	0.48	0.36	0.90	0.06
E71	200	6	¼	TBM6S	1.13	0.48	0.36	0.90	0.06
E6-516	20	6	⅝	TBM6S	1.32	0.60	0.49	1.03	0.06
E72	200	6	⅝	TBM6S	1.32	0.60	0.49	1.03	0.06
E6-38	20	6	⅜	TBM6S	1.32	0.60	0.49	1.03	0.06
E73	200	6	⅜	TBM6S	1.32	0.60	0.49	1.03	0.06
E6-12	20	6	½	TBM6S	1.49	0.82	0.55	1.08	0.06
E75	200	6	½	TBM6S	1.49	0.82	0.55	1.08	0.06
F4-10	20	4	#10	TBM6S	1.16	0.48	0.36	0.93	0.07
F26	200	4	#10	TBM6S	1.16	0.48	0.36	0.93	0.07
F4-14	20	4	¼	TBM6S	1.16	0.48	0.36	0.93	0.07
F71-TB	200	4	¼	TBM6S	1.16	0.48	0.36	0.93	0.07
F4-516	20	4	⅝	TBM6S	1.35	0.60	0.49	1.06	0.07
F72	200	4	⅝	TBM6S	1.35	0.60	0.49	1.06	0.07
F4-38	20	4	⅜	TBM6S	1.35	0.60	0.49	1.06	0.07
F73	200	4	⅜	TBM6S	1.35	0.60	0.49	1.06	0.07
F4-12	20	4	½	TBM6S	1.52	0.82	0.55	1.11	0.07
F75	200	4	½	TBM6S	1.52	0.82	0.55	1.11	0.07

Diagram

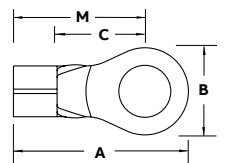

Ring terminals

Non-insulated large ring terminals — Tubular



Cat. no.	Pkg. qty.	Wire range (AWG)	Bolt hole (in.)	Rec. tool	Dimensions (in.)				Stock thick. (in.)
					A	B	C	M	
D10161	200	8/8AN	#8	ERG4005	1.15	0.41	0.28	0.95	0.04
D10361	200	8/8AN	#10	ERG4008	1.15	0.41	0.28	0.95	0.04
D10711	200	8/8AN	¼		1.20	0.45	0.36	0.97	0.04
D10721	200	8/8AN	⅝		1.28	0.56	0.36	1.00	0.04
D10731	200	8/8AN	¾		1.28	0.56	0.36	1.00	0.04
D975*	200	8/8AN	½	TBM6S	1.46	0.83	0.49	1.06	0.04
E10261	200	6/6AN	#10	ERG4005	1.26	0.49	0.24	1.02	0.04
E10711	200	6/6AN	¼	ERG4008	1.26	0.49	0.27	0.99	0.04
E10721	200	6/6AN	⅝		1.38	0.60	0.34	1.04	0.04
E10731	200	6/6AN	¾		1.38	0.60	0.34	1.04	0.04
F10261	100	4/4AN	#10	ERG4008	1.37	0.55	0.30	1.07	0.04
F10711	100	4/4AN	¼		1.37	0.55	0.30	1.07	0.04
F10721	100	4/4AN	⅝		1.42	0.62	0.34	1.08	0.04
F10731	100	4/4AN	¾		1.42	0.62	0.34	1.08	0.04
F975*	200	4/4AN	½	TBM6S	1.49	0.83	0.45	1.10	0.04
G926	100	2/2AN	#10	ERG4008	1.59	0.69	0.40	1.26	0.05
G2-14	10	2/2AN	¼	TBM6S	1.59	0.69	0.40	1.26	0.05
G971	100	2/2AN	¼		1.59	0.69	0.40	1.26	0.05
G2-516	10	2/2AN	⅝		1.59	0.69	0.40	1.26	0.05
G972	100	2/2AN	⅝		1.59	0.69	0.40	1.26	0.05
G2-38	10	2/2AN	¾		1.59	0.69	0.40	1.26	0.05
G973	100	2/2AN	¾		1.59	0.69	0.40	1.26	0.05
G2-12	10	2/2AN	½		1.79	0.80	0.49	1.36	0.05
G975	100	2/2AN	½		1.79	0.80	0.49	1.36	0.05

*Braze seam

AN – Aircraft wire



Cat. no.	Pkg. qty.	Wire range (AWG)	Bolt hole (in.)	Rec. tool	Dimensions (in.)				Stock thick. (in.)
					A	B	C	M	
H10-14	10	1AN-1/0	¼	ERG4008	1.65	0.77	0.43	1.32	0.05
H971	100	1AN-1/0	¼	TBM6S	1.65	0.77	0.43	1.32	0.05
H972	100	1AN-1/0	⅝		1.65	0.77	0.43	1.32	0.05
H973	100	1AN-1/0	¾		1.65	0.77	0.43	1.32	0.05
H975	100	1AN-1/0	½		1.85	0.77	0.54	1.41	0.05
J971	50	1/0AN-2/0	¼	TBM6S	1.94	0.84	0.48	1.53	0.06
J972	50	1/0AN-2/0	⅝		1.94	0.84	0.48	1.53	0.06
J20-38	10	1/0AN-2/0	¾		1.84	0.83	0.46	1.46	0.06
J973	50	1/0AN-2/0	¾		1.99	0.84	0.53	1.58	0.06
J974	50	1/0AN-2/0	⅞		1.99	0.89	0.51	1.56	0.06
J975	50	1/0AN-2/0	½		1.99	0.89	0.51	1.56	0.06
J976	50	1/0AN-2/0	⅝		1.99	0.89	0.51	1.56	0.06
K971	50	2/0AN-3/0	¼	TBM6S	2.08	0.93	0.54	1.69	0.06
K972	50	2/0AN-3/0	⅝		2.08	0.93	0.54	1.69	0.06
K30-38	5	2/0AN-3/0	¾		2.08	0.93	0.54	1.69	0.06
K973	50	2/0AN-3/0	¾		2.08	0.93	0.54	1.69	0.06
K974	50	2/0AN-3/0	⅞		2.08	0.93	0.54	1.70	0.06
K975	50	2/0AN-3/0	½		2.08	0.93	0.54	1.70	0.06
L971	50	3/0AN-4/0	¼	TBM6S	2.25	1.04	0.57	1.77	0.07
L972	50	3/0AN-4/0	⅝		2.25	1.04	0.57	1.77	0.07
L40-38	5	3/0AN-4/0	¾		2.25	1.04	0.57	1.77	0.07
L973	50	3/0AN-4/0	¾		2.25	1.04	0.57	1.77	0.07
L974	50	3/0AN-4/0	⅞		2.25	1.04	0.57	1.77	0.07
L975	50	3/0AN-4/0	½		2.25	1.04	0.57	1.77	0.07
M972	50	4/0AN-250	⅝	TBM6S	2.28	1.12	0.62	1.90	0.07
M250-38	5	4/0AN-250	¾		2.40	1.12	0.65	1.91	0.07
M973	50	4/0AN-250	¾		2.40	1.12	0.65	1.91	0.07
M974	50	4/0AN-250	⅞		2.40	1.12	0.65	1.91	0.07
M975	50	4/0AN-250	½		2.40	1.12	0.65	1.91	0.07

Diagram

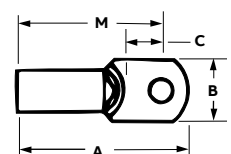

Ring terminals

Insulated heavy-duty ring terminals



Cat. no.	Pkg. qty.	Wire range (AWG)	Max. ins. (in.)	Bolt hole (in.)	Rec. tool	Dimensions (in.)				Stock thick. (in.)
						A	B	C	M	
Nylon										
RBC14-6	50	16-14 Heavy-duty	0.210	#6	WT2130A	0.98	0.25	0.29	0.85	0.05
RBC14-8	50	16-14 Heavy-duty	0.210	#8	WT2130A	1.04	0.39	0.29	0.85	0.05
RBC863	500	16-14 Heavy-duty	0.210	#8	WT2130A	1.04	0.39	0.29	0.85	0.05
RBC14-10	50	16-14 Heavy-duty	0.210	#10	WT2130A	1.04	0.39	0.29	0.85	0.05
RBC14-14	50	16-14 Heavy-duty	0.210	¼	WT2130A	1.10	0.51	0.29	0.85	0.05
RBC713	500	16-14 Heavy-duty	0.210	¼	WT2130A	1.10	0.51	0.29	0.85	0.05
RBC14-516	50	16-14 Heavy-duty	0.210	⅝	WT2130A	1.21	0.54	0.38	0.94	0.05
RBC14-38	50	16-14 Heavy-duty	0.210	⅜	WT2130A	1.26	0.63	0.38	0.94	0.05
RBC14-12	50	16-14 Heavy-duty	0.210	½	WT2130A	1.49	0.76	0.54	1.11	0.05
RBC753	500	16-14 Heavy-duty	0.210	½	WT2130A	1.49	0.76	0.54	1.11	0.05
Vinyl										
14RBC-6	50	16-14 Heavy-duty	0.210	#6	WT2130A	1.06	0.25	0.29	0.93	0.05
RBC857	500	16-14 Heavy-duty	0.210	#6	WT2130A	1.06	0.25	0.29	0.93	0.05
14RBC-8	50	16-14 Heavy-duty	0.210	#8	WT2130A	1.13	0.39	0.29	0.93	0.05
RBC867	500	16-14 Heavy-duty	0.210	#8	WT2130A	1.13	0.39	0.29	0.93	0.05
14RBC-10	50	16-14 Heavy-duty	0.210	#10	WT2130A	1.13	0.39	0.29	0.93	0.05
RBC877	500	16-14 Heavy-duty	0.210	#10	WT2130A	1.13	0.39	0.29	0.93	0.05
14RBC-14	50	16-14 Heavy-duty	0.210	¼	WT2130A	1.19	0.51	0.29	0.93	0.05
RBC717	500	16-14 Heavy-duty	0.210	¼	WT2130A	1.19	0.51	0.29	0.93	0.05
14RBC-516	50	16-14 Heavy-duty	0.210	⅝	WT2130A	1.29	0.54	0.38	1.03	0.05
RBC727	500	16-14 Heavy-duty	0.210	⅝	WT2130A	1.29	0.54	0.38	1.03	0.05
14RBC-38	50	16-14 Heavy-duty	0.210	⅜	WT2130A	1.34	0.63	0.38	1.03	0.05
RBC797	500	16-14 Heavy-duty	0.210	⅜	WT2130A	1.34	0.63	0.38	1.03	0.05
14RBC-12	50	16-14 Heavy-duty	0.210	½	WT2130A	1.57	0.76	0.54	1.19	0.05

Diagram

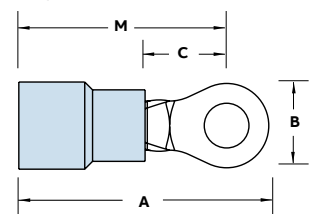

Ring terminals

Non-insulated heavy-duty ring terminals



Cat. no.	Pkg. qty.	Wire range (AWG)	Bolt hole (in.)	Rec. tool	Dimensions (in.)				Stock thick. (in.)
					A	B	C	M	
BC14-6	50	16-14 Heavy-duty	#6	ERG4002, ERG4005	0.81	0.25	0.29	0.68	0.05
BC85	500	16-14 Heavy-duty	#6	ERG4002, ERG4005	0.81	0.25	0.29	0.68	0.05
BC14-8	50	16-14 Heavy-duty	#8	ERG4002, ERG4005	0.87	0.39	0.29	0.68	0.05
BC86	500	16-14 Heavy-duty	#8	ERG4002, ERG4005	0.87	0.39	0.29	0.68	0.05
BC14-10	50	16-14 Heavy-duty	#10	ERG4002, ERG4005	0.87	0.39	0.29	0.68	0.05
BC87	500	16-14 Heavy-duty	#10	ERG4002, ERG4005	0.87	0.39	0.29	0.68	0.05
BC14-14	50	16-14 Heavy-duty	¼	ERG4002, ERG4005	0.93	0.51	0.29	0.68	0.05
BC71	500	16-14 Heavy-duty	¼	ERG4002, ERG4005	0.93	0.51	0.29	0.68	0.05
BC14-516	50	16-14 Heavy-duty	⅝	ERG4002, ERG4005	1.04	0.54	0.38	0.77	0.05
BC72	500	16-14 Heavy-duty	⅝	ERG4002, ERG4005	1.04	0.54	0.38	0.77	0.05
BC14-38	50	16-14 Heavy-duty	⅜	ERG4002, ERG4005	1.09	0.63	0.38	0.77	0.05
BC79	500	16-14 Heavy-duty	⅜	ERG4002, ERG4005	1.09	0.63	0.38	0.77	0.05
BC14-12	50	16-14 Heavy-duty	½	ERG4002, ERG4005	1.32	0.76	0.54	0.94	0.05
BC75	500	16-14 Heavy-duty	½	ERG4002, ERG4005	1.32	0.76	0.54	0.94	0.05

Diagram

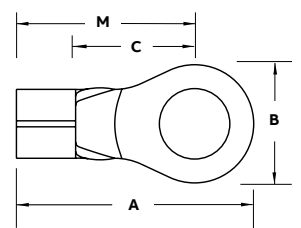

Ring terminals

High-temperature non-insulated and Tefzel insulated rings



High-temperature non-insulated rings — 1200 °F max.



Diagram	Cat. no.	Pkg. qty.	Wire range (AWG)	Max. ins. (in.)	Bolt hole (in.)	Rec. tool	Dimensions (in.)				Stock thick. (in.)
							A	B	C	M	
	NW18-10	100	20-18	2.5	#10	WT1377	0.63	0.31	0.28	0.38	0.032
	NW52	1,000	20-18	2.5	#8	WT1377	0.63	0.31	0.28	0.38	0.032
	NW81	1,000	16-14	2.5	#6	WT1377	0.66	0.31	0.28	0.51	0.040
	NW14-8	100	16-14	2.5	#8	WT1377	0.66	0.31	0.28	0.51	0.040
	NW14-10	100	16-14	2.5	#10	WT1377	0.66	0.31	0.28	0.51	0.040
	NW83	1,000	16-14	2.5	#10	WT1377	0.66	0.31	0.28	0.51	0.040
	NW14-12	100	16-14	2.5	#12*	WT1377	0.66	0.31	0.28	0.51	0.040
	NW84	1,000	16-14	2.5	#12*	WT1377	0.66	0.31	0.28	0.51	0.040
	NW10-8	50	12-10	3	#8	WT1377	0.66	0.31	0.2	0.51	0.040
	NW10-10	50	12-10	3	#10	WT1377	0.66	0.31	0.2	0.51	0.040
	NW10-12	50	12-10	3	#12*	WT1377	0.66	0.31	0.2	0.51	0.040

* #12 stud is smaller than 1/4 in. stud



Tefzel insulated rings — Insulation grip



Diagram	Cat. no.	Pkg. qty.	Wire range (AWG)	Max. ins. (in.)	Bolt hole (in.)	Rec. tool	Dimensions (in.)				Stock thick. (in.)
							A	B	C	M	
	RAT853	1,000	22-18	0.140	#6	WT145C	0.81	0.25	0.25	0.69	0.03
	RAT863	1,000	22-18	0.140	#8	WT145C	0.84	0.31	0.25	0.69	0.03
	RAT873	1,000	22-18	0.140	#10	WT145C	0.84	0.31	0.25	0.69	0.03
	RAT713	1,000	22-18	0.140	1/4	WT145C	1.07	0.46	0.31	0.84	0.03
	RBT853	1,000	16-14	0.170	#6	WT145C	0.84	0.31	0.25	0.69	0.03
	RBT863	1,000	16-14	0.170	#8	WT145C	0.84	0.31	0.25	0.69	0.03
	RBT873	1,000	16-14	0.170	#10	WT145C	0.84	0.31	0.25	0.69	0.03
	RBT713	1,000	16-14	0.170	1/4	WT145C	1.08	0.46	0.31	0.81	0.03
	RCT333	500	12-10	0.210	#6	WT145C	1.00	0.37	0.27	0.81	0.04
	RCT863	500	12-10	0.210	#8	WT145C	1.00	0.37	0.27	0.81	0.04
	RCT363	500	12-10	0.210	#10	WT145C	1.00	0.37	0.27	0.81	0.04
	RCT713	500	12-10	0.210	1/4	WT145C	1.11	0.52	0.32	0.85	0.04
	RCT703	500	12-10	0.210	3/16	WT145C	1.23	0.52	0.31	0.96	0.04
	RCT733	500	12-10	0.210	3/8	WT145C	1.29	0.58	0.35	1.00	0.04

Tefzel is a registered trademark of DuPont

Ring terminals

Nylon-insulated rectangular rings



Cat. No.	Pkg. Qty.	Bolt Hole	Wire range (AWG)	Rec. Tool	Dimensions (in.)				BU-Ships tongue shape	Stock thick. (in.)
					A	B	C	M		
RA486	1,000	#4	22-18	ERG4001	0.796	0.237	0.237	0.143	L86P-1	0.03
RA485	1,000	#4	22-18	ERG4001	1.015	0.237	0.404	0.195	L85P-1	0.03
RA483	1,000	#5	22-18	ERG4001	0.859	0.277	0.277	0.143	L83P-1	0.03
RA484	1,000	#6	22-18	ERG4001	1.015	0.237	0.404	0.195	L84P-1	0.03
RA481	1,000	#6	22-18	ERG4001	1.109	0.302	0.465	0.227	L81P-1	0.03
RA482	1,000	#8	22-18	ERG4001	1.109	0.302	0.465	0.227	L82P-1	0.03
RA480*	1,000	#8	22-18	ERG4001	1.359	0.390	0.621	0.310	L80P-1	0.03
RB486	1,000	#4	16-14	ERG4001	0.796	0.237	0.237	0.143	L86P-2	0.03
RB485	1,000	#4	16-14	ERG4001	1.015	0.237	0.404	0.195	L85P-2	0.03
RB483	1,000	#5	16-14	ERG4001	0.859	0.277	0.277	0.143	L83P-2	0.03
RB484	1,000	#6	16-14	ERG4001	1.015	0.237	0.404	0.195	L84P-2	0.03
RB481	1,000	#6	16-14	ERG4001	1.109	0.302	0.465	0.227	L81P-2	0.03
RB482	1,000	#8	16-14	ERG4001	1.109	0.302	0.465	0.227	L82P-2	0.03
RB480*	1,000	#8	16-14	ERG4001	1.359	0.390	0.621	0.310	L80P-2	0.03
RC486	500	#4	12-10	ERG4001	0.984	0.237	0.237	0.143	L86P-3	0.04
RC485	500	#4	12-10	ERG4001	1.187	0.237	0.404	0.195	L85P-3	0.04
RC483	500	#5	12-10	ERG4001	1.046	0.277	0.277	0.143	L83P-3	0.04
RC484	500	#6	12-10	ERG4001	1.203	0.237	0.404	0.195	L84P-3	0.04
RC481	500	#6	12-10	ERG4001	1.281	0.302	0.465	0.227	L81P-3	0.04
RC482	500	#8	12-10	ERG4001	1.281	0.302	0.465	0.227	L82P-3	0.04
RC480*	500	#8	12-10	ERG4001	1.531	0.390	0.621	0.310	L80P-3	0.04

* Not available on tape.

Note: RA, RB, RC486 for use with BU-Ships terminal board types 26TB. RA, RB, RC485 for use with 25TB and 27TB. RA, RB, RC483 for use with 8TB. RA, RB, RC484 for use with 10TB and 11TB. RA, RB, RC481 for use with 6TB, 7TB and 9TB. RA, RB, RC482 for use with 15TB. RA, RB, RC480 for use with 3TB, 4TB, 5TB, 16TB, 17TB and 18TB.

Note:
22-18 ga. = 1-2 Navy
16-14 ga. = 2-1/2-4 Navy
12-10 ga. = 6-9 Navy

Diagram

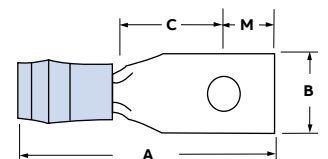

Ring terminals

Non-insulated rectangular rings



Cat. no.	Pkg. qty.	Bolt hole	Wire range (AWG)	Rec. Tool	Dimensions (in.)				BU-Ships tongue shape	Stock thick. (in.)
					A	B	C	M		
A486	1,000	#4	22-18	ERG4002	0.65	0.237	0.237	0.143	L86	0.03
A485	1,000	#4	22-18	ERG4002	0.87	0.237	0.404	0.195	L85	0.03
A483	1,000	#5	22-18	ERG4002	0.70	0.277	0.277	0.143	L83	0.03
A484	1,000	#6	22-18	ERG4002	0.87	0.237	0.404	0.195	L84	0.03
A481	1,000	#6	22-18	ERG4002	0.96	0.302	0.465	0.227	L81	0.03
A482	1,000	#8	22-18	ERG4002	0.96	0.302	0.465	0.227	L82	0.03
A480*	1,000	#8	22-18	ERG4002	1.21	0.390	0.621	0.310	L80	0.03
B486	1,000	#4	16-14	ERG4002, ERG4005	0.65	0.237	0.237	0.143	L86	0.03
B485	1,000	#4	16-14	ERG4002, ERG4005	0.87	0.237	0.404	0.195	L85	0.03
B483	1,000	#5	16-14	ERG4002, ERG4005	0.70	0.277	0.277	0.143	L83	0.03
B484	1,000	#6	16-14	ERG4002, ERG4005	0.87	0.237	0.404	0.195	L84	0.03
B481	1,000	#6	16-14	ERG4002, ERG4005	0.96	0.302	0.465	0.227	L81	0.03
B482	1,000	#8	16-14	ERG4002, ERG4005	0.96	0.302	0.465	0.227	L82	0.03
B480*	1,000	#8	16-14	ERG4002, ERG4005	1.21	0.390	0.621	0.310	L80	0.03
C486	500	#4	12-10	ERG4002, ERG4005	0.73	0.237	0.237	0.143	L86	0.04
C485	500	#4	12-10	ERG4002, ERG4005	0.90	0.237	0.404	0.195	L85	0.04
C483	500	#5	12-10	ERG4002, ERG4005	0.76	0.277	0.277	0.143	L83	0.04
C484	500	#6	12-10	ERG4002, ERG4005	0.94	0.237	0.404	0.195	L84	0.04
C481	500	#6	12-10	ERG4002, ERG4005	1.03	0.302	0.465	0.227	L81	0.04
C482	500	#8	12-10	ERG4002, ERG4005	1.03	0.302	0.465	0.227	L82	0.04
C480*	500	#8	12-10	ERG4002, ERG4005	1.27	0.390	0.621	0.310	L80	0.04

* Not available on tape.

Note: A, B, C486 for use with BU-Ships terminal board types 26TB. A, B, C485 for use with 25TB, 27TB. A, B, C483 for use with 8TB. A, B, C484 for use with 10TB and 11TB. A, B, C481 for use with 6TB, 7TB and 9TB. A, B, C482 for use with 15TB. A, B, C480 for use with 3TB, 5TB, 16TB, 17TB and 18TB.

Note:
 22-18 ga. = 1-2 Navy
 16-14 ga. = 2-1/2-4 Navy
 12-10 ga. = 6-9 Navy

Diagram

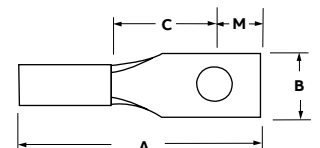

Flag terminals

Non-insulated flags

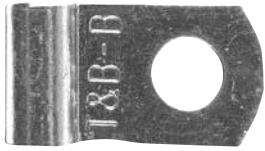

Cat. no.	Pkg. qty.	Wire range (AWG)	Bolt hole (in.)	Rec. tool	Dimensions (in.)				Stock thick. (in.)
					A	B	C	M	
AB14-6A	100	22-14	#6	ERG4004	0.55	0.31	0.22	0.39	0.03
AB51	1,000	22-14	#6	ERG4004	0.55	0.31	0.22	0.39	0.03
AB14-8A	100	22-14	#8	ERG4004	0.55	0.31	0.22	0.39	0.03
AB52	1,000	22-14	#8	ERG4004	0.55	0.31	0.22	0.39	0.03
AB14-10A	100	22-14	#10	ERG4004	0.55	0.31	0.22	0.39	0.03
AB53	1,000	22-14	#10	ERG4004	0.55	0.31	0.22	0.39	0.03
C51	500	12-10	#6	ERG4004	0.66	0.31	0.25	0.48	0.04
C10-8A	50	12-10	#8	ERG4004	0.66	0.31	0.25	0.48	0.04
C52-TB	500	12-10	#8	ERG4004	0.66	0.31	0.25	0.48	0.04
C10-10A	50	12-10	#10	ERG4004	0.66	0.31	0.25	0.48	0.04
C53	500	12-10	#10	ERG4004	0.66	0.31	0.25	0.48	0.04
D236	200	8	#10	WT129	0.83	0.50	0.25	0.59	0.06
D226	200	8	#10	WT129	0.90	0.50	0.29	0.64	0.06
D271	200	8	¼	WT129	0.92	0.50	0.33	0.68	0.06
E226	200	6	#10	WT129	0.93	0.50	0.29	0.69	0.06
E271	200	6	¼	WT129	0.99	0.50	0.33	0.73	0.06
E272	200	6	⅜	WT129	1.05	0.50	0.41	0.81	0.06
F226	200	4	#10	WT129	1.07	0.56	0.33	0.80	0.07
F271	200	4	¼	WT129	1.10	0.63	0.33	0.80	0.07
F272	200	4	⅜	WT129	1.18	0.63	0.41	0.88	0.07
F273	200	4	⅝	WT129	1.20	0.63	0.43	0.90	0.07
G671	100	2	¼	WT129	1.20	0.63	0.33	0.89	0.08
G672	100	2	⅜	WT129	1.28	0.63	0.41	0.97	0.08
G673	100	2	⅝	WT129	1.32	0.63	0.46	1.02	0.08
H672	50	1/0	⅜	13642M	1.31	0.63	0.41	1.01	0.10
H673	50	1/0	⅝	13642M	1.36	0.63	0.46	1.06	0.10
J672	50	2/0	⅜	13642M	1.46	0.75	0.41	1.10	0.10
J673	50	2/0	⅝	13642M	1.51	0.75	0.46	1.15	0.10
J675	50	2/0	½	13642M	1.67	0.75	0.55	1.24	0.10
K672	50	3/0	⅜	13642M	1.59	0.81	0.41	1.19	0.11
K673	50	3/0	⅝	13642M	1.64	0.81	0.46	1.24	0.11
K675	50	3/0	½	13642M	1.76	0.81	0.55	1.34	0.11
M673	50	250 kcmil	⅜	13642M	1.89	1.0	0.46	1.43	0.13
M675	50	250 kcmil	½	13642M	1.99	1.0	0.55	1.52	0.13

Diagram

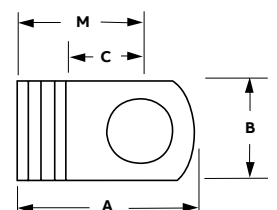

Fork terminals

Nylon-insulated forks



- Fork terminals enable easy installation because the mounting screw does not have to be completely removed
- Brazed-seam barrel is serrated for high pull-out value
- Terminal is high-conductivity electrolytic copper, electro-tin plated
- Insulation is colour-coded
- Vinyl-insulated fork terminals have extra-long PVC insulation sleeve for protection and stress relief at wire's flex point



Diagram	Cat. no.	Pkg. qty.	Wire range (AWG)	Max. ins. (in.)	Bolt hole (in.)	Rec. tool	Dimensions (in.)				Stock thick. (in.)
							A	B	C	M	
	RA18-6F	100	22-16	0.136	#6	ERG4001	0.83	0.25	0.25	0.71	0.02
	RA1103	1,000	22-16	0.136	#6	ERG4001	0.83	0.25	0.25	0.71	0.02
	RA18-8F	100	22-16	0.136	#8	ERG4001	0.86	0.31	0.25	0.71	0.02
	RA1123	1,000	22-16	0.136	#8	ERG4001	0.86	0.31	0.25	0.71	0.02
	RA18-10F	100	22-16	0.136	#10	ERG4001	0.86	0.31	0.25	0.71	0.02
	RA1153	1,000	22-16	0.136	#10	ERG4001	0.86	0.31	0.25	0.71	0.02
	RA18-14F	100	22-16	0.136	¼	ERG4001	0.95	0.44	0.31	0.70	0.02
	RA1163	1,000	22-16	0.136	¼	ERG4001	0.95	0.44	0.31	0.70	0.02
	RB14-6F	100	18-14	0.162	#6	ERG4001	0.87	0.31	0.25	0.71	0.03
	RB1113	1,000	18-14	0.162	#6	ERG4001	0.87	0.31	0.25	0.71	0.03
	RB14-8F	100	18-14	0.162	#8	ERG4001	0.87	0.31	0.25	0.71	0.03
	RB1123	1,000	18-14	0.162	#8	ERG4001	0.87	0.31	0.25	0.71	0.03
	RB14-10F	100	18-14	0.162	#10	ERG4001	0.87	0.38	0.25	0.71	0.03
	RB1153	1,000	18-14	0.162	#10	ERG4001	0.87	0.38	0.25	0.71	0.03
	RB14-14F	100	18-14	0.162	¼	ERG4001	0.95	0.44	0.28	0.74	0.03
	RB1163	1,000	18-14	0.162	¼	ERG4001	0.95	0.44	0.28	0.74	0.03
	RB1103	1,000	18-14	0.162	#6	ERG4001	0.74	0.28	0.16	0.60	0.03
	RB1124	1,000	18-14	0.190	#8	ERG4001	0.95	0.31	0.25	0.79	0.03
	RB1154	1,000	18-14	0.190	#10	ERG4001	0.95	0.31	0.25	0.79	0.03
	RC10-6F	50	12-10	0.210	#6	ERG4001	0.97	0.31	0.27	0.81	0.04
	RC1113	500	12-10	0.210	#6	ERG4001	0.97	0.31	0.27	0.81	0.04
	RC10-8F	50	12-10	0.210	#8	ERG4001	1.00	0.37	0.27	0.81	0.04
	RC1123	500	12-10	0.210	#8	ERG4001	1.00	0.37	0.27	0.81	0.04
	RC10-10F	50	12-10	0.210	#10	ERG4001	1.00	0.37	0.27	0.81	0.04
	RC1153	500	12-10	0.210	#10	ERG4001	1.00	0.37	0.27	0.81	0.04
	RC10-14F	50	12-10	0.210	¼	ERG4001	1.12	0.50	0.27	0.86	0.04
	RC1163	500	12-10	0.210	¼	ERG4001	1.12	0.50	0.27	0.86	0.04
	RC1124	500	12-10	0.250	#8	ERG4001	1.10	0.37	0.27	0.91	0.04
RC1154	500	12-10	0.250	#10	ERG4001	1.10	0.37	0.27	0.91	0.04	

Add suffix "X" for wider wire entry to accommodate heavy wall insulation

Fork terminals

Nylon-insulated locking forks



Diagram	Cat. no.	Pkg. qty.	Wire range (AWG)	Max. ins. (in.)	Bolt hole (in.)	Rec. tool	Dimensions (in.)				Stock thick. (in.)
							A	B	C	M	
	RA18-6FL	100	22-16	0.136	#6	ERG4001	0.86	0.25	0.25	0.71	0.02
	RA2213	1,000	22-16	0.136	#6	ERG4001	0.86	0.25	0.25	0.71	0.02
	RA18-8FL	100	22-16	0.136	#8	ERG4001	0.86	0.29	0.25	0.71	0.02
	RA2243	1,000	22-16	0.136	#8	ERG4001	0.86	0.29	0.25	0.71	0.02
	RA18-10FL	100	22-16	0.136	#10	ERG4001	0.86	0.29	0.25	0.71	0.02
	RA2253	1,000	22-16	0.136	#10	ERG4001	0.86	0.29	0.25	0.71	0.02
	RB14-6FL	100	18-14	0.162	#6	ERG4001	0.87	0.25	0.25	0.71	0.03
	RB2213	1,000	18-14	0.162	#6	ERG4001	0.87	0.25	0.25	0.71	0.03
	RB2214	1,000	18-14	0.162	#6	ERG4001	0.95	0.25	0.25	0.79	0.03
	RB14-8FL	100	18-14	0.162	#8	ERG4001	0.87	0.29	0.25	0.71	0.03
	RB2233	1,000	18-14	0.162	#8	ERG4001	0.87	0.29	0.25	0.71	0.03
	RB14-10FL	100	18-14	0.162	#10	ERG4001	0.87	0.29	0.25	0.71	0.03
	RB2253	1,000	18-14	0.162	#10	ERG4001	0.87	0.29	0.25	0.71	0.03
	RB2254	1,000	18-14	0.190	#10	ERG4001	0.95	0.29	0.25	0.71	0.03
	RC10-6FL	50	12-10	0.210	#6	ERG4001	0.97	0.31	0.27	0.81	0.04
	RC2203	500	12-10	0.210	#6	ERG4001	0.97	0.31	0.27	0.81	0.04
	RC2204	1,000	12-10	0.250	#6	ERG4001	1.07	0.31	0.27	0.91	0.04
	RC10-8FL	50	12-10	0.210	#8	ERG4001	1.00	0.37	0.27	0.81	0.04
	RC2213	500	12-10	0.210	#8	ERG4001	1.00	0.37	0.27	0.81	0.04
	RC10-10FL	50	12-10	0.210	#10	ERG4001	1.00	0.37	0.27	0.81	0.04
	RC2223	500	12-10	0.210	#10	ERG4001	1.00	0.37	0.27	0.81	0.04
	RC2224	500	12-10	0.250	#10	ERG4001	1.10	0.37	0.27	0.91	0.04
	RC10-14FL	50	12-10	0.210	¼	ERG4001	1.12	0.50	0.32	0.86	0.04
	RC2233	500	12-10	0.210	¼	ERG4001	1.12	0.50	0.32	0.86	0.04

Fork terminals

Nylon- and vinyl-insulated forks



Nylon-insulated forks — Flanged tongue



Cat. no.	Pkg. qty.	Wire range (AWG)	Max. ins. (in.)	Bolt hole	Rec. tool	Dimensions (in.)				Stock thick. (in.)
						A	B	C	M	
RA18-6FS	100	22-16	0.136	#6	ERG4001	0.75	0.28	0.16	0.62	0.02
RA1203	1,000	22-16	0.136	#6	ERG4001	0.75	0.28	0.16	0.62	0.02
RA18-8FS	100	22-16	0.136	#8	ERG4001	0.89	0.31	0.23	0.65	0.02
RA1223	1,000	22-16	0.136	#8	ERG4001	0.89	0.31	0.23	0.65	0.02
RA18-10FS	100	22-16	0.136	#10	ERG4001	0.93	0.38	0.26	0.68	0.02
RA1253	1,000	22-16	0.136	#10	ERG4001	0.93	0.38	0.26	0.68	0.02
RB14-6FS	100	18-14	0.162	#6	ERG4001	0.74	0.28	0.16	0.60	0.03
RB1203	1,000	18-14	0.162	#6	ERG4001	0.74	0.28	0.16	0.60	0.03
RB14-8FS	100	18-14	0.162	#8	ERG4001	0.89	0.31	0.23	0.66	0.03
RB1223	1,000	18-14	0.162	#8	ERG4001	0.89	0.31	0.23	0.66	0.03
RB14-10FS	100	18-14	0.162	#10	ERG4001	0.94	0.38	0.27	0.69	0.03
RB1253	1,000	18-14	0.162	#10	ERG4001	0.94	0.38	0.27	0.69	0.03
RB1204	1,000	18-14	0.190	#6	ERG4001	0.79	0.28	0.16	0.67	0.03
RB1224	1,000	18-14	0.190	#8	ERG4001	0.94	0.31	0.23	0.71	0.03
RC10-8FS	50	12-10	0.210	#8	ERG4001	0.97	0.34	0.23	0.73	0.04
RC1223	500	12-10	0.210	#8	ERG4001	0.97	0.34	0.23	0.73	0.04
RC10-10FS	50	12-10	0.210	#10	ERG4001	1.00	0.38	0.26	0.74	0.04
RC1253	500	12-10	0.210	#10	ERG4001	1.00	0.38	0.26	0.74	0.04
RC1224	1,000	12-10	0.250	#8	ERG4001	1.08	0.34	0.23	0.80	0.04
RC1254	1,000	12-10	0.250	#10	ERG4001	1.12	0.38	0.26	0.86	0.04

Vinyl-insulated forks



Cat. no.	Pkg. qty.	Wire range (AWG)	Max. ins. (in.)	Bolt hole (in.)	Rec. tool	Dimensions (in.)				Stock thick. (in.)
						A	B	C	M	
18RA-6F	100	22-16	0.150	#6	ERG4001	0.94	0.25	0.27	0.81	0.02
RA1167	1,000	22-16	0.150	#6	ERG4001	0.94	0.25	0.27	0.81	0.02
18RA-8F	100	22-16	0.150	#8	ERG4001	0.97	0.31	0.27	0.81	0.02
RA1147	1,000	22-16	0.150	#8	ERG4001	0.97	0.31	0.27	0.81	0.02
18RA-10F	100	22-16	0.150	#10	ERG4001	0.97	0.31	0.27	0.81	0.02
RA1157	1,000	22-16	0.150	#10	ERG4001	0.97	0.31	0.27	0.81	0.02
14RB-6F	100	18-14	0.170	#6	ERG4001	0.97	0.31	0.27	0.81	0.03
RB647	1,000	18-14	0.170	#6	ERG4001	0.97	0.31	0.27	0.81	0.03
14RB-6FS	100	18-14	0.170	#6	ERG4001	0.89	0.30	0.25	0.75	0.03
14RB-8F	100	18-14	0.170	#8	ERG4001	0.97	0.31	0.27	0.81	0.03
RB657	1,000	18-14	0.170	#8	ERG4001	0.97	0.31	0.27	0.81	0.03
14RB-10F	100	18-14	0.170	#10	ERG4001	0.97	0.31	0.27	0.81	0.03
RB1157	1,000	18-14	0.170	#10	ERG4001	0.97	0.31	0.27	0.81	0.03
14RB-14F	100	18-14	0.170	3/4	ERG4001	1.11	0.44	0.38	0.89	0.03
RB1717	1,000	18-14	0.170	3/4	ERG4001	1.11	0.44	0.38	0.89	0.03
10RC-6F	50	12-10	0.210	#6	ERG4001	1.09	0.31	0.27	0.90	0.04
RC1337	500	12-10	0.210	#6	ERG4001	1.09	0.31	0.27	0.90	0.04
10RC-8F	50	12-10	0.210	#8	ERG4001	1.09	0.38	0.27	0.90	0.04
RC1147	500	12-10	0.210	#8	ERG4001	1.09	0.38	0.27	0.90	0.04
10RC-10F	50	12-10	0.210	#10	ERG4001	1.09	0.38	0.27	0.90	0.04
RC1157	500	12-10	0.210	#10	ERG4001	1.09	0.38	0.27	0.90	0.04
10RC-14F	50	12-10	0.210	3/4	ERG4001	1.15	0.50	0.37	0.90	0.04
RC1167	500	12-10	0.210	3/4	ERG4001	1.15	0.50	0.37	0.90	0.04

Diagram

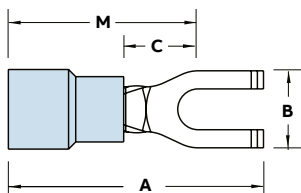

Diagram

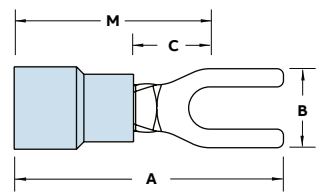

Fork terminals

Vinyl-insulated and non-insulated forks



Vinyl-insulated forks — Expanded insulation



Cat. no.	Pkg. qty.	Wire range (AWG)	Max. ins. (in.)	Bolt hole (in.)	Rec. tool	Dimensions (in.)				Stock thick. (in.)
						A	B	C	M	
18RA-6FX	100	22-16	0.170	#6	ERG4001	0.94	0.25	0.27	0.81	0.02
RA1167-170	1,000	22-16	0.170	#6	ERG4001	0.94	0.25	0.27	0.81	0.02
18RA-8FX	100	22-16	0.170	#8	ERG4001	0.97	0.31	0.27	0.81	0.02
RA1147-170	1,000	22-16	0.170	#8	ERG4001	0.97	0.31	0.27	0.81	0.02
18RA-10FX	100	22-16	0.170	#10	ERG4001	0.97	0.31	0.27	0.81	0.02
RA1157-170	1,000	22-16	0.170	#10	ERG4001	0.97	0.31	0.27	0.81	0.02
14RB-6FX	100	18-14	0.200	#6	ERG4001	0.97	0.31	0.27	0.81	0.03
RB647-200	1,000	18-14	0.200	#6	ERG4001	0.97	0.31	0.27	0.81	0.03
14RB-8FX	100	18-14	0.200	#8	ERG4001	0.97	0.31	0.27	0.81	0.03
RB657-200	1,000	18-14	0.200	#8	ERG4001	0.97	0.31	0.27	0.81	0.03
14RB-10FX	100	18-14	0.200	#10	ERG4001	0.97	0.31	0.27	0.81	0.03
RB1157-200	1,000	18-14	0.200	#10	ERG4001	0.97	0.31	0.27	0.81	0.03
10RC-8FX	50	12-10	0.250	#8	ERG4001	1.11	0.38	0.27	0.90	0.04
RC1147-250	500	12-10	0.250	#8	ERG4001	1.11	0.38	0.27	0.90	0.04
10RC-10FX	50	12-10	0.250	#10	ERG4001	1.11	0.38	0.27	0.90	0.04
RC1157-250	500	12-10	0.250	#10	ERG4001	1.11	0.38	0.27	0.90	0.04
10RC-14FX	50	12-10	0.250	¼	ERG4001	1.17	0.50	0.37	0.90	0.04

Non-insulated locking fork terminals



Cat. no.	Pkg. qty.	Wire range (AWG)	Bolt hole (in.)	Rec. tool	Dimensions (in.)				Stock thick. (in.)
					A	B	C	M	
A18-6F	100	22-16	#6	ERG4002	0.72	0.25	0.27	0.59	0.02
A116	1,000	22-16	#6		0.72	0.25	0.27	0.59	0.02
A18-8F	100	22-16	#8		0.75	0.31	0.27	0.59	0.02
A114	1,000	22-16	#8		0.75	0.31	0.27	0.59	0.02
A18-10F	100	22-16	#10		0.75	0.31	0.27	0.59	0.02
A115-TB	1,000	22-16	#10		0.75	0.31	0.27	0.59	0.02
B14-6F	100	18-14	#6	ERG4002	0.75	0.31	0.27	0.59	0.03
B64	1,000	18-14	#6	ERG4005	0.75	0.31	0.27	0.59	0.03
B19	1,000	18-14	#6		0.66	0.25	0.13	0.50	0.03
B14-8F	100	18-14	#8		0.75	0.31	0.27	0.59	0.03
B65-TB	1,000	18-14	#8		0.75	0.31	0.27	0.59	0.03
B14-10F	100	18-14	#10		0.75	0.31	0.27	0.59	0.03
B115	1,000	18-14	#10		0.75	0.31	0.27	0.59	0.03
B14-14F	100	18-14	¼		0.90	0.44	0.38	0.68	0.03
C10-6F	50	12-10	#6	ERG4002	0.77	0.31	0.27	0.63	0.04
C133	500	12-10	#6	ERG4005	0.77	0.31	0.27	0.63	0.04
C10-8F	50	12-10	#8		0.82	0.38	0.27	0.63	0.04
C114	500	12-10	#8		0.82	0.38	0.27	0.63	0.04
C10-10F	50	12-10	#10		0.82	0.38	0.27	0.63	0.04
C115	500	12-10	#10		0.82	0.38	0.27	0.63	0.04
C10-14F	50	12-10	¼		0.98	0.50	0.37	0.73	0.04
C116-TB	500	12-10	¼		0.98	0.50	0.37	0.73	0.04

Diagram

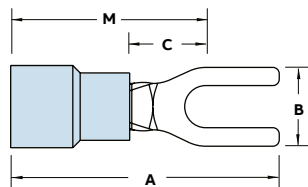

Diagram

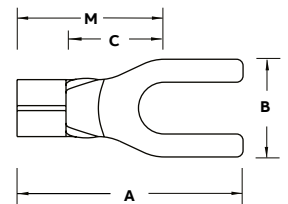

Fork terminals

Vinyl-insulated locking forks



Vinyl-insulated locking forks — Expanded insulation



Cat. no.	Pkg. qty.	Wire range (AWG)	Max. ins. (in.)	Bolt hole (in.)	Rec. tool	Dimensions (in.)				Stock thick. (in.)
						A	B	C	M	
18RA-6FLX	100	22-16	0.170	#6	ERG4001	0.97	0.25	0.25	0.81	0.02
RA2217-170	1,000	22-16	0.170	#6	ERG4001	0.97	0.25	0.25	0.81	0.02
18RA-8FLX	100	22-16	0.170	#8	ERG4001	0.97	0.29	0.25	0.81	0.02
18RA-10FLX	100	22-16	0.170	#10	ERG4001	0.97	0.29	0.25	0.81	0.02
RA2257-170	1,000	22-16	0.170	#10	ERG4001	0.97	0.29	0.25	0.81	0.02
14RB-6FLX	100	18-14	0.200	#6	ERG4001	0.97	0.31	0.27	0.81	0.03
RB2207-200	1,000	18-14	0.200	#6	ERG4001	0.97	0.31	0.27	0.81	0.03
RB2217-200	1,000	18-14	0.200	#6	ERG4001	0.97	0.29	0.27	0.81	0.03
14RB-8FLX	100	18-14	0.200	#8	ERG4001	0.97	0.31	0.27	0.81	0.03
RB2237-200	1,000	18-14	0.200	#8	ERG4001	0.97	0.31	0.27	0.81	0.03
14RB-10FLX	100	18-14	0.200	#10	ERG4001	0.97	0.31	0.27	0.81	0.03
RB2257-200	1,000	18-14	0.200	#10	ERG4001	0.97	0.31	0.27	0.81	0.03
10RC-6FLX	50	12-10	0.250	#6	ERG4001	1.07	0.31	0.27	0.91	0.04
RC2207-250	500	12-10	0.250	#6	ERG4001	1.07	0.31	0.27	0.91	0.04
10RC-8FLX	50	12-10	0.250	#8	ERG4001	1.10	0.37	0.27	0.91	0.04
10RC-10FLX	50	12-10	0.250	#10	ERG4001	1.10	0.37	0.27	0.91	0.04
RC2227-250	500	12-10	0.250	#10	ERG4001	1.10	0.37	0.27	0.91	0.04
10RC-14FLX	50	12-10	0.250	¼	ERG4001	1.22	0.50	0.32	0.96	0.04

Vinyl-insulated locking forks



Cat. no.	Pkg. qty.	Wire range (AWG)	Max. ins. (in.)	Bolt hole (in.)	Rec. tool	Dimensions (in.)				Stock thick. (in.)
						A	B	C	M	
18RA-6FL	100	22-16	0.150	#6	ERG4001	0.97	0.25	0.25	0.81	0.02
RA2217	1,000	22-16	0.150	#6	ERG4001	0.97	0.25	0.25	0.81	0.02
RA2227	1,000	22-16	0.150	#6	ERG4001	0.97	0.29	—	0.81	0.02
18RA-8FL	100	22-16	0.150	#8	ERG4001	0.97	0.29	0.25	0.81	0.02
RA2247	1,000	22-16	0.150	#8	ERG4001	0.97	0.29	0.25	0.81	0.02
18RA-10FL	100	22-16	0.150	#10	ERG4001	0.97	0.29	0.25	0.81	0.02
RA2257	1,000	22-16	0.150	#10	ERG4001	0.97	0.29	0.25	0.81	0.02
14RB-6FL	100	18-14	0.170	#6	ERG4001	0.97	0.25	0.27	0.81	0.03
RB2207	1,000	18-14	0.170	#6	ERG4001	0.97	0.25	0.27	0.81	0.03
RB2217	1,000	18-14	0.170	#6	ERG4001	0.97	0.29	0.27	0.81	0.03
14RB-8FL	100	18-14	0.170	#8	ERG4001	0.97	0.29	0.27	0.81	0.03
RB2237	1,000	18-14	0.170	#8	ERG4001	0.97	0.29	0.27	0.81	0.03
14RB-10FL	100	18-14	0.170	#10	ERG4001	0.97	0.29	0.27	0.81	0.03
RB2257	1,000	18-14	0.170	#10	ERG4001	0.97	0.29	0.27	0.81	0.03
10RC-6FL	50	12-10	0.220	#6	ERG4001	1.09	0.31	0.27	0.90	0.04
RC2207	500	12-10	0.220	#6	ERG4001	1.09	0.31	0.27	0.90	0.04
10RC-8FL	50	12-10	0.220	#8	ERG4001	1.09	0.37	0.27	0.90	0.04
RC2217	500	12-10	0.220	#8	ERG4001	1.09	0.37	0.27	0.90	0.04
10RC-10FL	50	12-10	0.220	#10	ERG4001	1.09	0.37	0.27	0.90	0.04
RC2227	500	12-10	0.220	#10	ERG4001	1.09	0.37	0.27	0.90	0.04
10RC-14FL	50	12-10	0.220	¼	ERG4001	1.09	0.49	0.27	0.90	0.04
RC2237	500	12-10	0.220	¼	ERG4001	1.09	0.49	0.27	0.90	0.04

Diagram

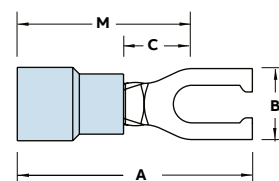

Fork terminals

Non-insulated locking forks



Cat. no.	Pkg. qty.	Wire range (AWG)	Bolt hole (in.)	Rec. tool	Dimensions (in.)				Stock thick. (in.)
					A	B	C	M	
A18-6FL	100	22-16	#6	ERG4002	0.75	0.25	0.27	0.59	0.02
A221	1,000	22-16	#6	ERG4002	0.75	0.25	0.27	0.59	0.02
A18-8FL	100	22-16	#8	ERG4002	0.75	0.29	0.27	0.59	0.02
A224	1,000	22-16	#8	ERG4002	0.75	0.29	0.27	0.59	0.02
A18-10FL	100	22-16	#10	ERG4002	0.75	0.29	0.27	0.59	0.02
A225	1,000	22-16	#10	ERG4002	0.75	0.29	0.27	0.59	0.02
B14-6FL	100	18-14	#6	ERG4002. ERG4005	0.75	0.25	0.27	0.59	0.03
B220	1,000	18-14	#6	ERG4002. ERG4005	0.75	0.25	0.27	0.59	0.03
B14-8FL	100	18-14	#8	ERG4002. ERG4005	0.75	0.29	0.27	0.59	0.03
B223	1,000	18-14	#8	ERG4002. ERG4005	0.75	0.29	0.27	0.59	0.03
B14-10FL	100	18-14	#10	ERG4002. ERG4005	0.75	0.29	0.27	0.59	0.03
B225	1,000	18-14	#10	ERG4002. ERG4005	0.75	0.29	0.27	0.59	0.03
C10-6FL	50	12-10	#6	ERG4002. ERG4005	0.85	0.31	0.27	0.66	0.04
C220-TB	500	12-10	#6	ERG4002. ERG4005	0.85	0.31	0.27	0.66	0.04
C10-8FL	50	12-10	#8	ERG4002. ERG4005	0.85	0.37	0.27	0.66	0.04
C221	500	12-10	#8	ERG4002. ERG4005	0.85	0.37	0.27	0.66	0.04
C10-10FL	50	12-10	#10	ERG4002. ERG4005	0.85	0.37	0.27	0.66	0.04
C222-TB	500	12-10	#10	ERG4002. ERG4005	0.85	0.37	0.27	0.66	0.04
C10-14FL	50	12-10	¼	ERG4002. ERG4005	0.85	0.49	0.27	0.66	0.04

Diagram

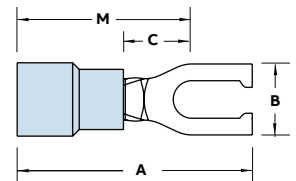

Pin terminals



- Provide an easy and effective way to terminate stranded wire into European/metric style terminal blocks
- Designed to prevent shorting, wire strand loss and/or wire pullout resulting from improper termination of stranded wire
- Designed to meet emerging global standards that require wire-to-metric style terminal block installations be terminated with a “pin” style terminal
- Available in vinyl-insulated, nylon-insulated and non-insulated styles
- All styles offered in 22 AWG to 10 AWG and compatible with existing Sta-Kon tooling



Cat. no.	Pkg. qty.	Wire range (AWG)	D (Dia.) (in.)	L (in.)	Rec. tool	Stock thick. (in.)
Non-insulated						
A47PT	1,000	22–18	0.075	0.63	ERG4002	0.02
B47PT	1,000	16–14	0.075	0.63	ERG4002	0.03
C55PT	500	12–10	0.106	0.76	ERG4002	0.04
Vinyl						
18RA-47PT	100	22–18	0.075	0.85	ERG4001	0.02
RA47PT	1,000	22–18	0.075	0.85	ERG4001	0.02
14RB-47PT	100	16–14	0.075	0.87	ERG4001	0.03
RB47PT	1,000	16–14	0.075	0.87	ERG4001	0.03
10RC-55PT	50	12–10	0.106	1.04	ERG4001	0.04
RC55PT	500	12–10	0.106	1.04	ERG4001	0.04
Nylon						
RA18-47PT	100	22–18	0.075	0.85	ERG4001	0.02
RA147PT	1,000	22–18	0.075	0.85	ERG4001	0.02
RB14-47PT	100	16–14	0.075	0.87	ERG4001	0.03
RB147PT	1,000	16–14	0.075	0.87	ERG4001	0.03
RC10-55PT	50	12–10	0.106	1.04	ERG4001	0.04
RC155PT	500	12–10	0.106	1.04	ERG4001	0.04

Diagrams

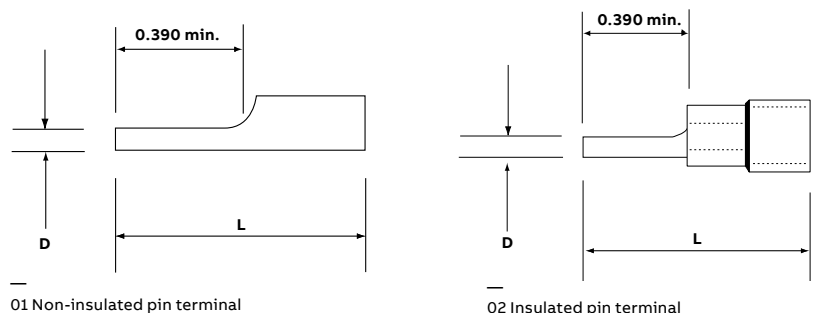

Butt splices



Vinyl-insulated butt splices — Expanded insulation



Diagram	Cat. no.	Pkg. qty.	Wire range (AWG)	Max. ins. (in.)	Rec. tool	Dimensions (in.)	
						A	B
	2RA18X	100	22-18	0.170	ERG4001	1.13	0.25
	RAA217-170	1,000	22-18	0.170	ERG4001	1.13	0.25
	RAA217	1,000	22-18	0.150	ERG4001	1.13	0.23
	2RB14X	100	16-14	0.200	ERG4001	1.13	0.26
	RBB217-200	1,000	16-14	0.200	ERG4001	1.13	0.26
	RBB217	1,000	16-14	0.170	ERG4001	1.13	0.24
	2RC10X	50	12-10	0.250	ERG4001	1.31	0.31
	RCC217-250	500	12-10	0.250	ERG4001	1.31	0.31
	RCC217	1,000	12-10	0.210	ERG4001	1.31	0.28

Note: RCC217 is not expanded



Nylon-insulated aircraft splices

Diagram	Cat. no.	Pkg. qty.	Wire range (AWG)	Rec. tool	Dimensions (in.)	
					A	B
	2RZZ	50	26-22	ERG4006	1.22	0.15
	RZZ23	500	26-22	ERG4006	1.22	0.15
	2RAA	50	22-18	ERG4001	1.52	0.25
	RAA23	500	22-18	ERG4001	1.52	0.25
	2RBB	50	16-14	ERG4001	1.52	0.28
	RBB23	500	16-14	ERG4001	1.52	0.28
	2RCC	25	12-10	ERG4001	1.54	0.35



Nylon-insulated butt splices



Diagram	Cat. no.	Pkg. qty.	Wire range (AWG)	Max ins. (in.)	Rec. tool	Dimensions (in.)	
						A	B
	2RA18	100	22-18	0.115	ERG4001	1.19	0.18
	RAA21	1,000	22-18	0.115	ERG4001	1.19	0.18
	2RB14	100	16-14	0.148	ERG4001	1.19	0.21
	RBB21	1,000	16-14	0.148	ERG4001	1.19	0.21
	2RC10	50	12-10	0.210	ERG4001	1.26	0.28
	RCC21	500	12-10	0.210	ERG4001	1.26	0.28
	2RD8	25	8	0.340	ERG4007. TBM6S	1.69	0.36
	RDD27	200	8	0.340	ERG4007. TBM6S	1.69	0.36
	2RE6	20	6	0.420	ERG4007. TBM6S	1.85	0.45
	REE28	200	6	0.420	ERG4007. TBM6S	1.85	0.45
	2RF4	15	4	0.510	TBM6S	1.85	0.52

Butt splices

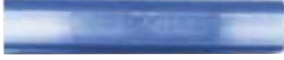

Tefzel insulated butt splices



Diagram	Cat. no.	Pkg. qty.	Max ins. (in.)	Wire range (AWG)	Rec. tool	Dimensions (in.)	
						A	B
	RAAT21	1,000	1.22	22-18	WT145C	1.22	0.115
	RBBT21	1,000	1.22	16-14	WT145C	1.22	0.148
	RCCT21	1,000	1.22	12-10	WT145C	1.22	0.210

Tefzel is a registered trademark of DuPont



Non-insulated butt splices



Diagram	Cat. no.	Pkg. qty.	Wire range (AWG)	Rec. tool	Dimensions (in.)	
					A	B
	2A-18	100	22-16	ERG4002	0.62	0.12
	AA2	1,000	22-16	ERG4002	0.62	0.12
	2B-14	100	18-14	ERG4002, ERG4005	0.62	0.16
	BB2	1,000	18-14	ERG4002, ERG4005	0.62	0.16
	2C-10	50	12-10	ERG4002, ERG4005	0.72	0.22
	CC2-TB	500	12-10	ERG4002, ERG4005	0.72	0.22
	2D-8	25	9-8-7	ERG4005, TBM6S	1.03	0.28
	DD102	200	9-8-7	ERG4005, TBM6S	1.03	0.28
	2E-6	20	6-5	ERG4005, TBM6S	1.12	0.37
	EE2	200	6-5	ERG4005, TBM6S	1.12	0.37
	2F-4	15	4-3	TBM6S	1.25	0.44
	FF2	200	4-3	TBM6S	1.25	0.44
	2G21	5	2-1	TBM6S	1.72	0.55
	GG2	25	2-1	TBM6S	1.72	0.55

Butt splices and parallel splices



Nylon-insulated butt splices



Diagram	Cat. no.	Pkg. qty.	Wire range (AWG)	Rec. tool	Dimensions (in.)	
					A	B
	2A20	100	22-18	ERG4001	0.84	0.20
	RAA24	1,000	22-18	ERG4001	0.84	0.20
	2B-16	100	18-16	ERG4001	0.84	0.23
	RBB25	1,000	18-16	ERG4001	0.84	0.23
	2C-12	50	14-12	ERG4001	0.90	0.28
	RCC26	500	14-12	ERG4001	0.90	0.28



- Wires are laid side by side in the connector, and the connection is made in one crimp
- Offers advantages in simplicity of installation and small size
- One crimp completes the splice

Parallel splices



Diagram	Cat. no.	Wire range (AWG)	CIR. mil range	Rec. tool	Length / A (in.)	O.D. / B (in.)	I.D. / C (in.)	Pkg. qty.
	A18-PS-M	22-16	509-3,260	ERG4002	0.314	0.129	0.086	1 000
	B14-PS-M	16-14	2,050-5,180	ERG4002	0.315	0.155	0.113	1 000
	C10-PS-D	12-10	5,180-13,100	ERG4005	0.380	0.220	0.170	500
	D8-PS-D	8	13,100-20,800	ERG4005	0.375	0.260	0.180	500
	E6-PS-D	6	20,800-33,100	WT115A	0.500	0.365	0.266	500
	F4-PS-W	4	33,100-52,600	WT115A	0.531	0.410	0.302	250
	G2-PS-W	2	52,600-83,700	WT115A	0.640	0.521	0.396	250
	H1/0-PS-C	1/0	83,700-119,500	TBM8-750M-1	0.750	0.571	0.446	100
	J2/0-PS-C	2/0	119,500-150,500	TBM8-750M-1	0.750	0.632	0.507	100
	K3/0-PS-L	3/0	150,500-190,000	TBM8-750M-1	0.750	0.701	0.564	50
	L4/0-PS-L	4/0	190,000-231,100	TBM8-750M-1	0.770	0.766	0.629	50
	M250-PS-Q	250 kcmil	231,100-300,000	TBM8-750M-1	1.063	0.926	0.749	25
	N300-PS-X	300 kcmil	300,000-380,000	TBM8-750M-1	1.125	1.100	0.882	10
	P400-PS-X	400 kcmil	380,000-478,000	TBM8-750M-1	1.250	1.200	0.956	10
	R500-PS-V	500 kcmil	478,000-600,000	TBM8-750M-1	1.438	1.330	1.060	5

The total combined cross sectional area of all wires must be within the circular mil area range. Rated at 150 °C.

Wire joints

Crimp-on wire joints, one-piece nylon self-insulated



Cat. no.	Pkg. qty.	Wire range (AWG)		Rec. tool	Dimensions (in.)	
		Min.	Max.		A	B
RB44	100	2 #18	2 #16	WT2000	0.31	0.78
RB4-TB	1,000	2 #18	2 #16	WT2000	0.31	0.78
RC55	50	4 #18	2 #12	WT2130A	0.43	0.95
RC6	500	4 #18	2 #12	WT2130A	0.43	0.95
RP12	100	3 #14	4 #12	WT2130A	0.53	1.00
RP7	1,000	3 #14	4 #12	WT2130A	0.53	1.00

Cat. no.	Allowable wire combinations						
	#22	#20	#18	#16	#14	#12	#10
RB4-TB/ RB44	-	-	2-3	-	-	-	-
	-	-	1-2	2	-	-	-
	3	-	-	-	-	-	-
	-	3	-	-	-	-	-
	3	-	1	-	-	-	-
	2	3	-	-	-	-	-
	1-2	-	2	-	-	-	-
	2	-	-	1	-	-	-
	-	3	1	-	-	-	-
	1	2	-	-	-	-	-
	-	2	-	1	-	-	-
	-	1	2	-	-	-	-

Cat. no.	Allowable wire combinations						
	#22	#20	#18	#16	#14	#12	#10
RC6/RC55	-	-	1-4	-	-	1	-
	-	-	-	1-3	-	1	-
	-	-	-	-	1-2	1	-
	-	-	-	-	-	2	-
	-	-	3-5	-	1	-	-
	-	-	-	2-4	1	-	-
	-	-	-	-	3	-	-
	-	-	1-4	-	2	-	-
	-	-	-	1-3	2	-	-
	-	-	1-3	-	3	-	-
	-	-	-	1	3	-	-
	-	-	-	2-5	-	-	-
	-	-	4-6	-	-	-	-

Cat. no.	Allowable wire combinations						
	#22	#20	#18	#16	#14	#12	#10
RP7/RP12	-	-	-	-	-	-	2
	-	-	-	-	-	1	1
	-	-	-	-	1	-	1
	-	-	-	-	-	2-4	-
	-	-	-	-	2-4	1	-
	-	-	-	-	1-3	2	-
	-	-	-	-	1	3	-
	-	-	-	-	3-6	-	-
	-	-	-	-	1	2-3	-
	-	-	-	-	2	1-2	-
	-	-	-	-	3	1-2	-
	-	-	-	-	4	1	-

Diagram

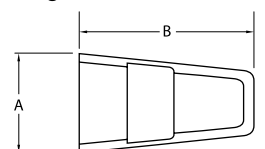

Wire joints

PT Series crimp-on wire joints

- 01 Two-piece barrel nylon insulator
- 02 Non-insulated barrel

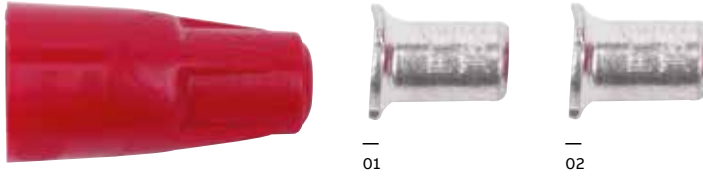

Diagrams	Cat. no.	Fig.	Pkg. qty.	Wire range (AWG)		Rec. tool	Dimensions (in.)	
				Min.	Max.		A	B
	PT66M	1	100	2 #18	3 #12 combination	WT161M	0.50	0.93
	PT6M	1	100	—	Insulator only	WT161M	0.50	0.93
	PT60M	1	100	2 #14	3 #12 connector only	WT161M	0.31	0.37
	PT70	2	200	2 #14	3 #12	WT161M	0.29	0.34
	PT70M	2	200	3 #18	4 #12	WT161M	0.31	0.37
	PT80	2	100	2 #16	4 #10	WT161M	0.35	0.62

90°C rated

- 01 Twist wires, insert through serrated barrel of wire joint (PT60M, PT70, PT70M, PT80).

Installation procedure for "PT" connectors

- 02 Crimp and trim off excess wire with WT161M hand tool.

- 03 Screw PT6M insulator firmly onto PT160M barrel.

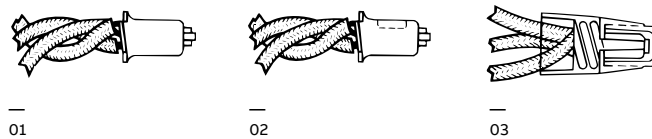

Wire joints

High-temperature wire joints



- Rated for temperatures up to 150 °C (302 °F), 600 V maximum
- Molded, one-piece nylon construction for electrical insulation, UL94-V2
- Brazed copper sleeve prevents separation of connection during crimping
- Internal serrations enable cold flow for increased conductivity and pull-out strength



Cat. no.	Pkg. qty.	Wire range (AWG)		Rec. tool	Dimensions (in.)	
		Min.	Max.		A	B
RB4-HT	1,000	2 #18	2 #16	WT2000	0.36	0.82
RB44-HT	100	2 #18	2 #16	WT2000	0.36	0.82
RC6-HT	500	3 #16	3 #14	ERG4001, WT2130A	0.48	0.95
RC551-HT	100	3 #16	3 #14	ERG4001, WT2130A	0.48	0.95
RP7-HT	500	3 #14	3 #12	ERG4007, WT2130A	0.53	1.00
RP12-HT	100	3 #14	3 #12	ERG4007, WT2130A	0.53	1.00

Wire joints UL listed combinations

Cat. no.	Solid or stranded AWG	Cat. no.	Solid or stranded AWG
RB4-TB, RB44, RB4-10M	(2) or (3) #18	RP7, RP-12	(2) to (4) #12 AWG
	(2) #16		(3) to (6) #14 AWG
	(1) #16 and (1) or (2) #18		(3) #12 and (1) #14
	(3) #22		(2) #12 and (1) #14
	(3) #20		(2) #12 and (2) #14
	(3) #22 and (1) #18		(2) #12 and (3) #14
	(2) #22 and (3) #20		(1) #12 and (2) #14
	(1) or (2) #22 and (2) #18		(1) #12 and (3) #14
	(2) #22 and (1) #16		(1) #12 and (4) #14
	(3) #20 and (1) #18		(2) #10
	(2) #20 and (1) #22		(1) #10 and (1) #12
	(2) #20 and (1) #16		(1) #10 and (1) #14
	(1) #20 and (2) #18		(1) #8 Tor. and (1) #16
	(1) #14 with (2), (3) or (4) #16		(1) #10 and (1) #16
	(1) #14 with (3), (4) or (5) #18		(1) #12 and (1) #16
(2) #14 with (1), (2), (3) or (4) #18			
(2) #14 with (1), (2) or (3) #16			
(3) #14			
(4) to (7) #18			
(3) #14 with (1) or (2) #18			
(3) #14 with (1) #16			
(1) #12 with (1), (2), (3) or (4) #18			
(1) #12 with (1), (2) or (3) #16			
(1) #12 with (1) or (2) #14			
(5) #16			

Heat-shrinkable terminals, splices and disconnects



- These ring terminals, butt splices and disconnects are self-insulated with heat-shrinkable polyolefin and internally coated sealant
 - Upon completed installation, a fully sealed connection is achieved to protect the joint against the degrading effects of galvanic action, corrosion and environmental exposure
- Note: Not approved for outdoor use

Heat-shrinkable ring terminals



Diagram	Cat. no.	Pkg. qty.	Wire range (AWG)	Max. ins. (in.)	Bolt hole (in.)	Rec. tool	Dimensions (in.)				Stock thick. (in.)
							A	B	C	M	
	RAS18-6X	100	22-18	0.170	#6	ERG4255	1.23	0.25	0.27	1.10	0.03
	RAS18-8X	100	22-18	0.170	#8	ERG4255	1.26	0.31	0.27	1.10	0.03
	RAS18-10X	100	22-18	0.170	#10	ERG4255	1.26	0.31	0.27	1.10	0.03
	RBS14-6X	100	16-14	0.200	#6	ERG4255	1.23	0.25	0.27	1.10	0.03
	RBS14-8X	100	16-14	0.200	#8	ERG4255	1.23	0.25	0.27	1.10	0.03
	RBS14-10X	100	16-14	0.200	#10	ERG4255	1.26	0.31	0.27	1.10	0.03
	RCS10-6X	50	12-10	0.250	#6	ERG4255	1.34	0.31	0.27	1.15	0.04
	RCS10-8X	50	12-10	0.250	#8	ERG4255	1.34	0.37	0.27	1.15	0.04
	RCS10-10X	50	12-10	0.250	#10	ERG4255	1.34	0.37	0.27	1.15	0.04
	RCS10-14X	50	12-10	0.250	¼	ERG4255	1.34	0.49	0.32	1.15	0.04



Heat-shrinkable locking fork terminals



Diagram	Cat. no.	Pkg. qty.	Wire range (AWG)	Max. ins. (in.)	Bolt hole (in.)	Rec. tool	Dimensions (in.)				Stock thick. (in.)
							A	B	C	M	
	RAS18-6FLX	100	22-18	0.170	#6	ERG4255	1.35	0.25	—	—	0.03
	RAS18-8FLX	100	22-18	0.170	#8	ERG4255	1.35	0.29	—	—	0.03
	RAS18-10FLX	100	22-18	0.170	#10	ERG4255	1.35	0.29	—	—	0.03
	RBS14-6FLX	100	16-14	0.200	#6	ERG4255	1.35	0.25	—	—	0.03
	RBS14-8FLX	100	16-14	0.200	#8	ERG4255	1.35	0.29	—	—	0.03
	RBS14-10FLX	100	16-14	0.200	#10	ERG4255	1.35	0.29	—	—	0.03
	RCS10-6FLX	50	12-10	0.250	#6	ERG4255	1.35	0.31	—	—	0.04
	RCS10-8FLX	50	12-10	0.250	#8	ERG4255	1.35	0.37	—	—	0.04
	RCS10-10FLX	50	12-10	0.250	#10	ERG4255	1.35	0.37	—	—	0.04
	RCS10-14FLX	50	12-10	0.250	¼	ERG4255	1.35	0.49	—	—	0.04

Heat-shrinkable terminals, splices and disconnects



Heat-shrinkable fully insulated female disconnects



Diagram	Cat. no.	Pkg. qty.	Wire range (AWG)	Max. ins. (in.)	Tab size (in.)	Rec. tool	A (in.)
	RAS18-250AX	25	22-18	0.170	0.250 x 0.032	ERG4255	1.82
	RBS14-250AX	25	16-14	0.200	0.250 x 0.032	ERG4255	1.77
	RCS10-250AX	25	12-10	0.250	0.250 x 0.032	ERG4255	1.80



Heat-shrinkable fully insulated male tabs



Diagram	Cat. no.	Pkg. qty.	Wire range (AWG)	Max. ins. (in.)	Tab size (in.)	Rec. tool	A (in.)
	18RAS-251TX	25	22-18	0.170	0.250 x 0.032	ERG4255	1.80
	14RBS-251TX	25	16-14	0.200	0.250 x 0.032	ERG4255	1.75
	10RCS-251TX	25	12-10	0.250	0.250 x 0.032	ERG4255	1.80



Heat-shrinkable butt splices



Diagram	Cat. no.	Pkg. qty.	Wire range (AWG)	Max. ins. (in.)	Rec. tool	Dimensions (in.)	
						A	B
	2RAS18X	50	22-18	0.170	ERG4255	1.50	0.25
	RAAS22X	500	22-18	0.170	ERG4255	1.50	0.25
	2RBS14X	50	16-14	0.200	ERG4255	1.50	0.26
	RBBS22X	500	16-14	0.200	ERG4255	1.50	0.26
	2RCS10X	25	12-10	0.250	ERG4255	1.60	0.31
	RCCS22X	250	12-10	0.250	ERG4255	1.60	0.31



Everything you need to make fully sealed connections in one handy kit

- Tools: (1) butane torch; (1) wire stripper; (1) ratchet crimp tool
- Butt splices: (20) #22-#18 AWG; (20) #16-#14 AWG; (15) #12-#10 AWG
- Ring terminals: (20) #16-#14 AWG #10 stud; (2) #16-#14 AWG #8 stud; (15) #12-#10 AWG ¼ in. stud

Heat-shrink terminal kit with tools

Cat. no.	Description	Std. pkg. qty.
STAPOUCH-HS	Heat-shrink terminal kit with tools	1

Disconnects and male tabs

250 Series — Female disconnects



- Internal barrel serrations and long barrel provide for maximum tensile strength
- Complete line of installing tools, engineered to match tool with terminal
- Funnel-entry insulators enable easier inserting of wire into barrel
- Colour-coded for easy installation

250 Series — female disconnects

- Female disconnect terminals and matching male tabs accommodate a range of #22–#10 AWG, and are available in non-insulated, partially insulated and fully insulated styles, in both nylon and vinyl
- Unique construction of the female disconnect
- offers long-term dependability
- Brazed-seam serrated barrel provides maximum tensile strength

187 Series — female disconnects

- Quick, reliable method of connection to terminal blocks and boards without the use of tools
- Female disconnect terminals and matching male tabs accommodate a range of #22–#10 AWG, and are available in non-insulated, partially insulated and fully insulated styles, in both nylon and vinyl
- Unique construction of the female disconnect offers long-term dependability



Cat. no.	Pkg. qty.	Wire range (AWG)	Max. ins. (in.)	Tab size (in.)	Fig.	Rec. tool	Dimensions (in.)	
							A	B
Nylon self-insulated								
RA18-250F	100	22–18	0.136	0.250 x 0.032	1	ERG4001	0.91	0.29
RA250-TB	1,000	22–18	0.136	0.250 x 0.032	1	ERG4001	0.91	0.29
RB14-250F	100	16–14	0.162	0.250 x 0.032	1	ERG4001	0.91	0.29
RB250	1,000	16–14	0.162	0.250 x 0.032	1	ERG4001	0.91	0.29
RC10-250F	50	12–10	0.215	0.250 x 0.032	1	ERG4001	1.04	0.29
RC250	500	12–10	0.215	0.250 x 0.032	1	ERG4001	1.04	0.29
Vinyl self-insulated								
18RA-250F	100	22–18	0.150	0.250 x 0.032	1	ERG4001	0.96	0.29
RA257	1,000	22–18	0.150	0.250 x 0.032	1	ERG4001	0.96	0.29
RA257-170	1,000	22–18	0.170	0.250 x 0.032	1	ERG4001	0.96	0.29
14RB-250F	100	16–14	0.170	0.250 x 0.032	1	ERG4001	0.96	0.29
RB257	1,000	16–14	0.170	0.250 x 0.032	1	ERG4001	0.96	0.29
RB257-200	1,000	16–14	0.200	0.250 x 0.032	1	ERG4001	0.96	0.29
10RC-250F	50	12–10	0.250	0.250 x 0.032	1	ERG4001	1.03	0.29
RC257	500	12–10	0.250	0.250 x 0.032	1	ERG4001	1.03	0.29
Nylon fully insulated								
18RA-2577	50	22–18	0.165	0.250 x 0.032	2	ERG4001	1.01	0.38
RA2573	1,000	22–18	0.165	0.250 x 0.032	2	ERG4001	1.01	0.38
14RB-2577	50	16–14	0.185	0.250 x 0.032	2	ERG4001	1.01	0.38
RB2573	1,000	16–14	0.185	0.250 x 0.032	2	ERG4001	1.01	0.38
10RC-2577	50	12–10	0.225	0.250 x 0.032	2	ERG4001	1.04	0.38
RC2573	500	12–10	0.225	0.250 x 0.032	2	ERG4001	1.04	0.38

Diagrams

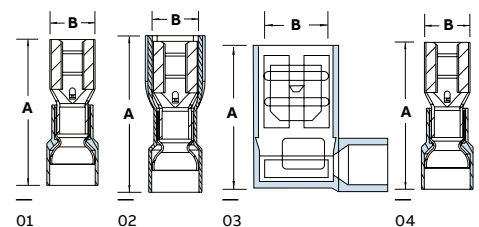

Disconnects and male tabs

250 Series — Female disconnects (cont.)



Cat. no.	Pkg. qty.	Wire range (AWG)	Max. ins. (in.)	Tab size (in.)	Fig.	Rec. tool	Dimensions (in.)	
							A	B
Nylon open top insulated 90° flag								
RA18-250A	50	22-18	0.170	0.250 x 0.032	3	ERG4001	0.80	0.71
RA2577F	500	22-18	0.170	0.250 x 0.032	3	ERG4001	0.80	0.71
RB14-250A	50	16-14	0.190	0.250 x 0.032	3	ERG4001	0.80	0.72
RB2577F	500	16-14	0.190	0.250 x 0.032	3	ERG4001	0.80	0.72
RC10-250A	50	12-10	0.245	0.250 x 0.032	3	ERG4001	0.80	0.88
RC2577F	500	12-10	0.245	0.250 x 0.032	3	ERG4001	0.80	0.88
Non-insulated								
A18-250	100	22-18	-	0.250 x 0.032	1	ERG4002	0.73	0.31
A250-TB	1,000	22-18	-	0.250 x 0.032	1	ERG4002	0.73	0.31
B14-250	100	16-14	-	0.250 x 0.032	1	ERG4002	0.73	0.31
B250	1,000	16-14	-	0.250 x 0.032	1	ERG4002	0.73	0.31
C10-250F	50	12-10	-	0.250 x 0.032	1	ERG4002	0.73	0.31
C250	500	12-10	-	0.250 x 0.032	1	ERG4002	0.73	0.31
Non-insulated/insulation grip								
B14-250F	100	16-14	-	0.250 x 0.032	4	WT110M	0.87	0.31
B250G	1,000	16-14	-	0.250 x 0.032	4	WT110M	0.87	0.31
Non-insulated 90° flag								
A18-250A	50	22-18	-	0.250 x 0.032	3	ERG4002	0.58	0.61
A252G	500	22-18	-	0.250 x 0.032	3	ERG4002	0.58	0.61
B14-250A	50	16-14	-	0.250 x 0.032	3	ERG4002. ERG4005	0.58	0.62
B252G	500	16-14	-	0.250 x 0.032	3	ERG4002. ERG4005	0.58	0.62
C10-250A	50	12-10	-	0.250 x 0.032	3	ERG4002. ERG4005	0.64	0.63
C252G	500	12-10	-	0.250 x 0.032	3	ERG4002. ERG4005	0.64	0.63

Diagrams

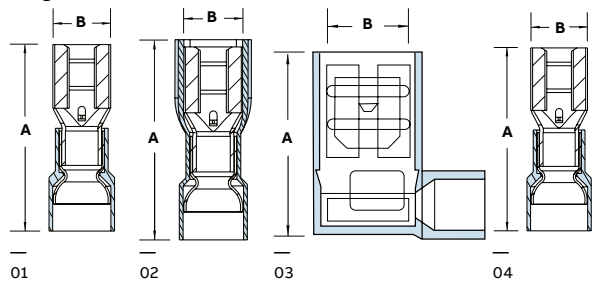

Disconnects and male tabs

250 Series — Nylon piggy-back disconnects



Cat. no.	Pkg. qty.	Wire range (AWG)	Max. ins. (in.)	Tab size (in.)	Rec. tool	Dimensions (in.)		
						A	B	C
RA18-250FP	100	22-18	0.136	0.250 x 0.032	WT112M. ERG4001	0.87	0.30	0.43
RA250P	1,000	22-18	0.136	0.250 x 0.032	WT112M. ERG4001	0.87	0.30	0.43
RB14-250FP	100	16-14	0.163	0.250 x 0.032	WT112M. ERG4001	0.87	0.30	0.43
RB250P	1,000	16-14	0.163	0.250 x 0.032	WT112M. ERG4001	0.87	0.30	0.43



Diagram

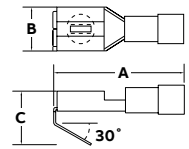

187 Series — Female disconnects



Cat. no.	Pkg. qty.	Wire range (AWG)	Max. ins. (in.)	Tab size (in.)	Fig.	Rec. tool	Dimensions (in.)	
							A	B
Nylon self-insulated								
RAD18-183	100	22-18	0.136	0.187 x 0.032	1	ERG4001	0.83	0.23
RAD1833	1,000	22-18	0.136	0.187 x 0.032	1	ERG4001	0.83	0.23
RAD18-182	100	22-18	0.136	0.187 x 0.020	1	ERG4001	0.83	0.23
RAD1823	1,000	22-18	0.136	0.187 x 0.020	1	ERG4001	0.83	0.23
RBD14-183	100	16-14	0.163	0.187 x 0.032	1	ERG4001	0.83	0.23
RBD1833	1,000	16-14	0.163	0.187 x 0.032	1	ERG4001	0.83	0.23
RBD14-182	100	16-14	0.163	0.187 x 0.020	1	ERG4001	0.83	0.23
RBD1823	1,000	16-14	0.163	0.187 x 0.020	1	ERG4001	0.83	0.23
Vinyl self-insulated								
18RAD-183	100	22-18	0.150	0.187 x 0.032	1	ERG4001	0.85	0.23
RAD1837	1,000	22-18	0.150	0.187 x 0.032	1	ERG4001	0.85	0.23
18RAD-182	100	22-18	0.150	0.187 x 0.020	1	ERG4001	0.85	0.23
RAD1827	1,000	22-18	0.150	0.187 x 0.020	1	ERG4001	0.85	0.23
14RBD-183	100	16-14	0.170	0.187 x 0.032	1	ERG4001	0.85	0.23
RBD1837	1,000	16-14	0.170	0.187 x 0.032	1	ERG4001	0.85	0.23
14RBD-182	100	16-14	0.170	0.187 x 0.020	1	ERG4001	0.85	0.23
RBD1827	1,000	16-14	0.170	0.187 x 0.020	1	ERG4001	0.85	0.23



Diagrams

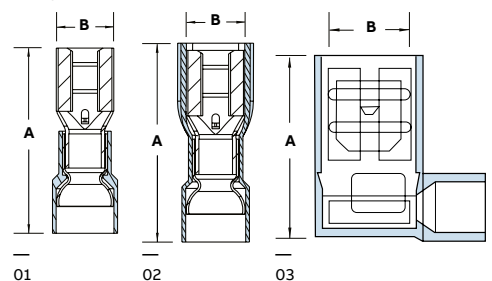

Disconnects and male tabs

187 Series — Female disconnects (cont.)



Cat. no.	Pkg. qty.	Wire range (AWG)	Max. ins. (in.)	Tab size (in.)	Fig.	Rec. tool	Dimensions (in.)	
							A	B
Nylon fully insulated								
18RAD-18377	100	22-18	0.150	0.187 x 0.032	2	ERG4001	0.89	0.30
RAD18377	1,000	22-18	0.150	0.187 x 0.032	2	ERG4001	0.89	0.30
18RAD-18277	100	22-18	0.150	0.187 x 0.020	2	ERG4001	0.89	0.30
RAD18277	1,000	22-18	0.150	0.187 x 0.020	2	ERG4001	0.89	0.30
14RBD-18377	100	16-14	0.170	0.187 x 0.032	2	ERG4001	0.89	0.30
RBD18377	1,000	16-14	0.170	0.187 x 0.032	2	ERG4001	0.89	0.30
14RBD-18277	100	16-14	0.170	0.187 x 0.020	2	ERG4001	0.89	0.30
RBD18277	1,000	16-14	0.170	0.187 x 0.020	2	ERG4001	0.89	0.30
Non-insulated								
AD18-183	100	22-18	-	0.187 x 0.032	1	ERG4002	0.64	0.23
AD183	1,000	22-18	-	0.187 x 0.032	1	ERG4002	0.64	0.23
AD18-182	100	22-18	-	0.187 x 0.020	1	ERG4002	0.64	0.23
AD182	1,000	22-18	-	0.187 x 0.020	1	ERG4002	0.64	0.23
BD14-183	100	16-14	-	0.187 x 0.032	1	ERG4002	0.64	0.23
BD183	1,000	16-14	-	0.187 x 0.032	1	ERG4002	0.64	0.23
BD14-182	100	16-14	-	0.187 x 0.020	1	ERG4002	0.64	0.23
Nylon open tap insulated 90° flag								
RAD18-187A	50	22-18	0.150	0.187 x 0.032	3	ERG4001	0.74	0.59
RAD1877F	500	22-18	0.150	0.187 x 0.032	3	ERG4001	0.74	0.59
RAD18-188A	50	22-18	0.150	0.187 x 0.020	3	ERG4001	0.74	0.59
RAD1887F	500	22-18	0.150	0.187 x 0.020	3	ERG4001	0.74	0.59
RBD14-187A	50	16-14	0.170	0.187 x 0.032	3	ERG4001	0.74	0.61
RBD1877F	500	16-14	0.170	0.187 x 0.032	3	ERG4001	0.74	0.61
RBD14-188A	50	16-14	0.170	0.187 x 0.020	3	ERG4001	0.74	0.61
RBD1887F	500	16-14	0.170	0.187 x 0.020	3	ERG4001	0.74	0.61

Diagrams

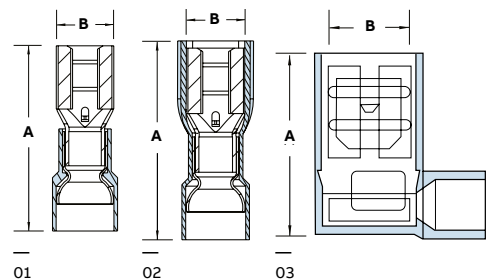

Disconnects and male tabs

250 Series — Male tabs



	Cat. no.	Pkg. qty.	Wire range (AWG)	Max. ins. (in.)	Tab size (in.)	Rec. tool	Dimensions (in.)	
							A	B
Vinyl self-insulated								
	18RA-250T	100	22-18	0.150	0.250 x 0.032	ERG4001	0.95	—
	RA2517	1,000	22-18	0.150	0.250 x 0.032	ERG4001	0.95	—
	14RB-250T	100	16-14	0.170	0.250 x 0.032	ERG4001	0.95	—
	RB2517	1,000	16-14	0.170	0.250 x 0.032	ERG4001	0.95	—
	10RC-250T	50	12-10	0.250	0.250 x 0.032	ERG4001	1.08	—
	RC2517	500	12-10	0.250	0.250 x 0.032	ERG4001	1.08	—
Nylon fully insulated								
	18RA-251T	50	22-18	0.150	0.250 x 0.032	ERG4001	1.13	0.45
	RA25177	500	22-18	0.150	0.250 x 0.032	ERG4001	1.13	0.45
	14RB-251T	50	16-14	0.170	0.250 x 0.032	ERG4001	1.13	0.45
	RB25177	500	16-14	0.170	0.250 x 0.032	ERG4001	1.13	0.45
	10RC-251T	25	12-10	0.210	0.250 x 0.032	ERG4001	1.17	0.45
	RC25177	500	12-10	0.210	0.250 x 0.032	ERG4001	1.17	0.45
Non-insulated/insulated grip								
	A18-250T	100	22-18	—	0.250 x 0.032	WT110M	0.87	—
	B14-250T	100	20-14	—	0.250 x 0.032	WT110M	0.87	—
Non-insulated								
	A18-251T	100	22-18	—	0.250 x 0.032	ERG4002	0.68	—
	A251	1,000	22-18	—	0.250 x 0.032	ERG4002	0.68	—
	B14-251T	100	16-14	—	0.250 x 0.032	ERG4002	0.68	—
	B251	1,000	16-14	—	0.250 x 0.032	ERG4002	0.68	—
	C10-251T	50	12-10	—	0.250 x 0.032	ERG4002	0.68	—

187 Series — Male tabs



	Cat. no.	Pkg. qty.	Wire range (AWG)	Max. ins. (in.)	Tab size (in.)	Rec. tool	Dimensions (in.)	
							A	B
Vinyl insulated								
	18RAD-187	100	22-18	0.150	0.187 x 0.032	ERG4001	0.87	—
	18RAD-188	100	22-18	0.150	0.187 x 0.020	ERG4001	0.87	—
	14RBD-187	100	16-14	0.170	0.187 x 0.032	ERG4001	0.87	—
	14RBD-188	100	16-14	0.170	0.187 x 0.020	ERG4001	0.87	—

Diagram

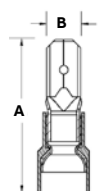



Disconnects and male tabs

Insulated coupler requires no tool.

250 Series — Adapters and coupler*



	Cat. no.	Pkg. qty.	Tab size (in.)	Dimensions (in.)	
				A	B
Non-insulated					
	F250TA	50	0.250 x 0.032	0.82	0.56
	FTA250	1,000	0.250 x 0.032	0.82	0.56
Insulated coupler					
	RB14-250	50	0.250 x 0.032	2.35	0.51
	RBB250	500	0.250 x 0.032	2.35	0.51

* Not UL Listed or CSA certified



Cat. no. F250TA — Material: brass Finish: tin-plated

Cat. no. RB14-250 — Material: brass Finish: none Insulation: vinyl

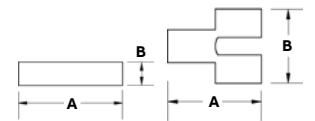
Diagrams



110 Series — Disconnects

	Cat. no.	Pkg. qty.	Wire range (AWG)	Max. ins. (in.)	Tab size (in.)	Rec. tool	Dimensions (in.)	
							A	B
Nylon-insulated								
	RA18-110F	100	22-18	0.110 x 0.032	0.110	ERG4006	0.75	0.15
	RA10-SK	1,000	22-18	0.110 x 0.032	0.110	ERG4006	0.75	0.15
	RA18-111F	100	22-18	0.110 x 0.020	0.110	ERG4006	0.75	0.15
	RA11	1,000	22-18	0.110 x 0.020	0.110	ERG4006	0.75	0.15
	RB14-110F	100	16-14	0.110 x 0.032	0.135	ERG4006	0.75	0.15
	RB10-SK	1,000	16-14	0.110 x 0.032	0.135	ERG4006	0.75	0.15
	RB14-111F	100	16-14	0.110 x 0.020	0.135	ERG4006	0.75	0.15
	RB11-TB	1,000	16-14	0.110 x 0.020	0.135	ERG4006	0.75	0.15
Non-insulated								
	A18-110F	100	22-18	0.110 x 0.032	-	WT111M. WT112M . WT2000	0.59	0.15
	A10-TB	1,000	22-18	0.110 x 0.032	-	WT111M. WT112M . WT2000	0.59	0.15
	A18-111F	100	22-18	0.110 x 0.020	-	WT111M. WT112M . WT2000	0.59	0.15
	A11	1,000	22-18	0.110 x 0.020	-	WT111M. WT112M . WT2000	0.59	0.15
	B14-110F	100	16-14	0.110 x 0.032	-	WT111M. WT112M . WT2000	0.59	0.15
	B10-TB	1,000	16-14	0.110 x 0.032	-	WT111M. WT112M . WT2000	0.59	0.15
	B14-111F	100	16-14	0.110 x 0.020	-	WT111M. WT112M . WT2000	0.59	0.15
	B11-TB	1,000	16-14	0.110 x 0.020	-	WT111M. WT112M . WT2000	0.59	0.15

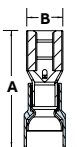

* Not UL Listed or CSA certified

Diagram



Disconnects and male tabs

Wristlock disconnects†

	Cat. no.	Pkg. qty.	Wire range (AWG)	Max. ins. (in.)	Rec. tool	Dimensions (in.)	
						A	B
Nylon-insulated							
	RA18D	50	22-18	0.136	WT2000	0.99	1.70
	RA23	1,000	22-18	0.136	WT2000	0.99	1.70
	RB14D	50	16-14	0.162	WT2000	0.99	1.70
	RB23	1,000	16-14	0.162	WT2000	0.99	1.70
Non-insulated							
	B14-D	50	16-14	0.187	WT110M	0.97	1.66
	B23	1,000	16-14	0.187	WT110M	0.97	1.66

—
Picture shows wristlock disconnect assembled as two pieces. Parts are sold by the piece not by assemblies.

† Not UL Listed

Luminaire disconnects

Disconnect ballasts under load for safe servicing – in compliance with NEC® requirements.



This cutaway shows how the Sta-Kon luminaire disconnect grips and holds the pushed-in wires securely after installation

Push-in luminaire disconnect

Each year, electricians sustain injuries while attempting to change ballasts without tripping the breaker because they're trying to avoid disconnecting other lighting and equipment from power. That's why recent changes to NEC and UL standards require a means of disconnecting power to non-residential fluorescent lighting ballasts.

In 2006, ABB developed the first UL Listed product to meet this need. In response to customer demand, the Sta-Kon push-in luminaire disconnect provides all the same safety benefits as the original, but installs even faster and easier.

- Enables electricians changing ballasts to easily disconnect incoming power for safe servicing without having to trip the main power breaker
- Installs easily – just strip de-energized wires and insert
- Disconnect halves snap together and separate easily – but won't accidentally disconnect
- Foolproof design eliminates the potential for incorrect installation and reverse polarity
- Fits through ½ in. knockouts for easy retrofit

- Ballast hot-lead wire entry is colour-coded black for easy visibility
- Finger-safe on both sides
- For use in all non-residential fluorescent lighting applications and in ordinary location HID lighting applications – both up to 600V, 4A maximum
- Complies with NEC, CEC, UL and CSA requirements
- Sold in mated pairs (male/line and female/load sides)

Specifications

- Housing: Polycarbonate
- Temperature rating: 105 °C (221 °F) max.
- Electrical rating: 600 V, 4 A max.
- Flammability rating: UL94V-2
- Contacts: Copper alloy
- Wire range: #18–#12 AWG solid copper
#14–#12 AWG stranded copper (19 strands or fewer)
- Standards: Complies with 2008 NEC 410.130(G) and CEC 30-308(4)
- Certifications: UL Listed, CSA Certified

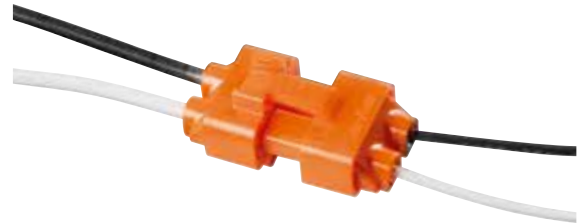

Sta-Kon push-in luminaire disconnect



Cat. no.	Description	Std. pkg. qty.
LD2P-Q	2-Wire push-in luminaire disconnect, distributor pack	25
LD2P-D	2-Wire push-in luminaire disconnect, bulk packaging	500

Note: If you prefer lead wires instead of a push-in design and/or need a 3-wire disconnect for switching or dimming applications, order the original Sta-Kon luminaire disconnect, 2-wire cat. no. LD2 (cat. no. LD2-D for bulk packaging) or 3-wire cat. no. LD3 (cat. no. LD3-D for bulk packaging). See following page.

Luminaire disconnects and disconnect installation tool



Luminaire disconnects

Cat. no.	Description
LD2C-D	2-pole luminaire disconnect (Marrettes not included)
LD3C-D	3-pole luminaire disconnect (Marrettes not included)
LD2-C	2-pole luminaire disconnect (2 x 4 Marrettes 333 /inner bag)
LD3-C	3-pole luminaire disconnect (6 of each Marrettes (331 + 333) /inner bag)



Packaging options

Cat. no.	Pkg. Format	Std. pkg. (min./mult.)
Bulk		
LD2C-D	Box	Sold without Marrettes Sold in multiple of 500
LD3C-D	Box	Inner: 50 per inner bag Outer: 250 per outer box Master: 500 in master box
Kits		
LD2-C	Bag	Sold with Marrettes Inner: 2 per inner bag
LD3-C	Bag	Sold in multiple of 20 Outer: 20 per outer box Master: 200 in master box



This one-of-a-kind tool may be used to seat all sizes of Sta-Kon disconnects.

Faster, easier and safer than manual seating of disconnects.

- Perfect for wire-harness assemblers and panel builders
- Dual-ended with slots to fit red and blue (male and female) or yellow disconnects
- Colour-coded dots for easy matching of disconnect with correct tool end
- Lightweight and only 5½ in. long — fits in a shirt pocket like a pen

Disconnect installation tool

Cat. No.	Description	Pkg. qty.
DT22-10	Sta-Kon disconnect installation tool	1

Ferrules



Features

- Ferrules ensure reliable electrical connections when terminating conductors in screw clamp terminal blocks
- Fraying and breaking of wire strands is prevented and the possibility of an unreliable connection is minimized
- Insulated ferrules prevent conductor breakage due to bending, wire stress or vibration, while facilitating wire insertions into the terminal block clamp
- Ferrules are the preferred alternative to twisting wire stands or tinning the wire end before terminating into a terminal block
- Ferrules are thin-walled copper tubes, which are mechanically crimped onto the ends of stranded wires
- They are easy to use — simply strip the wire, slide the ferrule onto the end of the wire and crimp
- Meets emerging global standards, requiring wire-to-metric style terminal block installations to be terminated with a “pin” style terminal

- Vinyl-insulated, nylon-insulated and non-insulated styles
- All styles offered in #22 AWG to #10 AWG and compatible with existing Sta-Kon tooling

How to apply a ferrule

- Strip the insulation from the end of the wire and insert into the insulated end of the ferrule
- Using the designated crimping tool, place the metal shaft into the tool's appropriate slot. Compress the tool to make a crescent-shape depression along the length of the ferrule
- Insert the crimped ferrule into the terminal block
- Tighten the ferrule and wire into the terminal block

Materials

- High-conductivity copper
- Tin plating

Insulated ferrules

Cat. no.	Conductor section		Colour	Dimensions in./mm					Installation tooling	Pkg. qty.
	AWG	mm ²		A	B	øC	øD	E		
F4004	26	0.14	Grey	0.413 / 10.5	0.236 / 6.0	0.031 / 0.80	0.079 / 2.0	0.010 / 0.25	T3, ERG4	500
F4005	26	0.14	Grey	0.492 / 12.5	0.315 / 8.0	0.031 / 0.80	0.079 / 2.0	0.010 / 0.25	T3, ERG4	500
F4006	24	0.25	Yellow	0.413 / 10.5	0.236 / 6.0	0.031 / 0.80	0.079 / 2.0	0.010 / 0.25	T3, ERG4	500
F4007	24	0.25	Yellow	0.492 / 12.5	0.315 / 8.0	0.031 / 0.80	0.079 / 2.0	0.010 / 0.25	T3, ERG4	500
F4008	22	0.34	Purple	0.413 / 10.5	0.236 / 6.0	0.031 / 0.80	0.079 / 2.0	0.010 / 0.25	T3, ERG4	500
F4009	22	0.34	Purple	0.492 / 12.5	0.315 / 8.0	0.031 / 0.80	0.079 / 2.0	0.010 / 0.25	T3, ERG4	500
F2020	20	0.50	White	0.453 / 11.5	0.236 / 6.0	0.043 / 1.1	0.098 / 2.5	0.006 / 0.15	T1, T3 & ERG4	500
F2021	20	0.50	White	0.531 / 13.5	0.315 / 8.0	0.043 / 1.1	0.098 / 2.5	0.006 / 0.15	T1, T3 & ERG4	500
F2022	20	0.50	White	0.610 / 15.5	0.394 / 10.0	0.043 / 1.1	0.098 / 2.5	0.006 / 0.15	T1, T3 & ERG4	500
F2023	18	0.75	Grey	0.472 / 12.0	0.236 / 6.0	0.051 / 1.3	0.110 / 2.8	0.006 / 0.15	T1, T3 & ERG4	500
F2024	18	0.75	Grey	0.551 / 14.0	0.315 / 8.0	0.051 / 1.3	0.110 / 2.8	0.006 / 0.15	T1, T3 & ERG4	500
F2025	18	0.75	Grey	0.630 / 16.0	0.394 / 10.0	0.051 / 1.3	0.110 / 2.8	0.006 / 0.15	T1, T3 & ERG4	500
F2026	18	0.75	Grey	0.709 / 18.0	0.472 / 12.0	0.051 / 1.3	0.110 / 2.8	0.006 / 0.15	T1, T3 & ERG4	500
F2027	18	1.00	Red	0.492 / 12.5	0.236 / 6.0	0.059 / 1.5	0.118 / 3.0	0.006 / 0.15	T1, T3 & ERG4	500
F2028	18	1.00	Red	0.571 / 14.5	0.315 / 8.0	0.059 / 1.5	0.118 / 3.0	0.006 / 0.15	T1, T3 & ERG4	500
F2029	18	1.00	Red	0.650 / 16.5	0.394 / 10.0	0.059 / 1.5	0.118 / 3.0	0.006 / 0.15	T1, T3 & ERG4	500
F2030	18	1.00	Red	0.728 / 18.5	0.472 / 12.0	0.059 / 1.5	0.118 / 3.0	0.006 / 0.15	T1, T3 & ERG4	500

Ferrule dimensions conform to DIN 46228, Part 4

Diagram

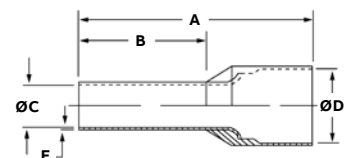

Ferrules

Insulated ferrules

Cat. no.	Conductor section		Colour	Dimensions in./mm					Installation tooling	Pkg. qty.
	AWG	mm ²		A	B	øC	øD	E		
F2031	16	1.50	Black	0.571 / 14.5	0.315 / 8.0	0.071 / 1.8	0.134 / 3.4	0.006 / 0.15	T1, T3 & ERG4	500
F2032	16	1.50	Black	0.650 / 16.5	0.394 / 10.0	0.071 / 1.8	0.134 / 3.4	0.006 / 0.15	T1, T3 & ERG4	500
F2033	16	1.50	Black	0.728 / 18.5	0.472 / 12.0	0.071 / 1.8	0.134 / 3.4	0.006 / 0.15	T1, T3 & ERG4	500
F2034	16	1.50	Black	0.965 / 24.5	0.708 / 18.0	0.071 / 1.8	0.134 / 3.4	0.006 / 0.15	T1, T3 & ERG4	500
F2035	14	2.50	Blue	0.591 / 15.0	0.315 / 8.0	0.091 / 2.3	0.165 / 4.2	0.006 / 0.15	T1, T3 & ERG4	500
F2036	14	2.50	Blue	0.748 / 19.0	0.472 / 12.0	0.091 / 2.3	0.165 / 4.2	0.006 / 0.15	T1, T3 & ERG4	500
F2037	14	2.50	Blue	0.984 / 25.0	0.708 / 18.0	0.091 / 2.3	0.165 / 4.2	0.006 / 0.15	T1, T3 & ERG4	500
F2038	12	4.00	Grey	0.889 / 17.5	0.394 / 10.0	0.114 / 2.9	0.189 / 4.8	0.008 / 0.20	ERG4	500
F2039	12	4.00	Grey	0.787 / 20.0	0.472 / 12.0	0.114 / 2.9	0.189 / 4.8	0.008 / 0.20	ERG4	500
F2040	12	4.00	Grey	1.024 / 26.0	0.708 / 18.0	0.114 / 2.9	0.189 / 4.8	0.008 / 0.20	ERG4	100
F2041	10	6.00	Yellow	0.787 / 20.0	0.472 / 12.0	0.142 / 3.6	0.244 / 6.2	0.008 / 0.20	ERG4	100
F2042	10	6.00	Yellow	0.984 / 25.0	0.708 / 18.0	0.142 / 3.6	0.244 / 6.2	0.008 / 0.20	ERG4	100
F2043	8	10.00	Red	0.827 / 21.0	0.472 / 12.0	0.181 / 4.6	0.295 / 7.5	0.008 / 0.20	ERG4	100
F2044	8	10.00	Red	1.063 / 27.0	0.708 / 18.0	0.181 / 4.6	0.295 / 7.5	0.008 / 0.20	ERG4	100
F2045	6	16.00	Blue	0.906 / 23.0	0.472 / 12.0	0.236 / 6.0	0.346 / 8.8	0.008 / 0.20	ERG4	100
F2046	6	16.00	Blue	1.142 / 29.0	0.708 / 18.0	0.236 / 6.0	0.346 / 8.8	0.008 / 0.20	ERG4	100
F2047	4	25.00	Yellow	1.142 / 29.0	0.630 / 18.0	0.295 / 7.5	0.433 / 11.0	0.008 / 0.20	ERG4	50
F2048	4	25.00	Yellow	1.220 / 31.0	0.708 / 18.0	0.295 / 7.5	0.433 / 11.0	0.008 / 0.20	ERG4	50
F2049	4	25.00	Yellow	1.378 / 35.0	0.866 / 22.0	0.295 / 7.5	0.433 / 11.0	0.008 / 0.20	ERG4	50
F2050	2	35.00	Red	1.181 / 30.0	0.630 / 16.0	0.335 / 8.5	0.492 / 12.5	0.008 / 0.20	ERG4	50
F2051	2	35.00	Red	1.260 / 32.0	0.708 / 18.0	0.335 / 8.5	0.492 / 12.5	0.008 / 0.20	ERG4	50
F2052	2	35.00	Red	1.535 / 39.0	0.984 / 25.0	0.335 / 8.5	0.492 / 12.5	0.008 / 0.20	ERG4	50
F2053	1	50.00	Blue	1.417 / 36.0	0.787 / 20.0	0.413 / 10.5	0.591 / 15.0	0.014 / 0.35	ERG4	50
F2054	1	50.00	Blue	1.614 / 41.0	0.984 / 25.0	0.413 / 10.5	0.591 / 15.0	0.014 / 0.35	ERG4	50

Ferrule dimensions conform to DIN 46228, Part 4

Diagram

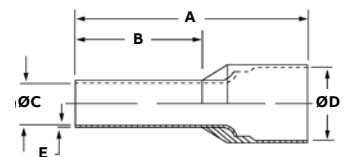

Ferrules



Strip lengths for insulated ferrules

Cat. no.	Pin length (in.)	Min. strip length (in.)	Max. strip length (in.)
F2020	0.236	0.3147	0.354
F2021	0.315	0.3937	0.433
F2022	0.394	0.4727	0.512
F2023	0.236	0.3147	0.354
F2024	0.315	0.3937	0.433
F2025	0.394	0.4727	0.512
F2026	0.472	0.5507	0.59
F2027	0.236	0.3147	0.354
F2028	0.315	0.3937	0.433
F2029	0.394	0.4727	0.512
F2030	0.472	0.5507	0.59
F2031	0.315	0.3937	0.433
F2032	0.394	0.4727	0.512
F2033	0.472	0.5507	0.59
F2034	0.708	0.7867	0.826
F2035	0.315	0.3937	0.433
F2036	0.472	0.5507	0.59
F2037	0.708	0.7867	0.826
F2038	0.394	0.4727	0.512
F2039	0.472	0.5507	0.59
F2040	0.708	0.7867	0.826
F2041	0.472	0.5507	0.59
F2042	0.708	0.7867	0.826
F2043	0.472	0.5507	0.59
F2044	0.708	0.7867	0.826
F2045	0.472	0.5507	0.59

Cat. no.	Pin length (in.)	Min. strip length (in.)	Max. strip length (in.)
F2046	0.708	0.7867	0.826
F2047	0.63	0.7087	0.748
F2048	0.708	0.7867	0.826
F2049	0.866	0.9447	0.984
F2050	0.53	0.6087	0.648
G2051	0.708	0.7867	0.826
G2052	0.984	1.0627	1.102
G2053	0.787	0.8657	0.905
F2054	0.984	1.0627	1.102
F4000	0.315	0.3937	0.433
F4001	0.315	0.3937	0.433
F4002	0.315	0.3937	0.433
F4003	0.315	0.3937	0.433
F4004	0.236	0.3147	0.354
F4005	0.315	0.3937	0.433
F4006	0.236	0.3147	0.354
F4007	0.315	0.3937	0.433
F4008	0.236	0.3147	0.354
F4009	0.315	0.3937	0.433
F4020	0.315	0.3937	0.433
F4021	0.315	0.3937	0.433
F4022	0.315	0.3937	0.433
F4023	0.315	0.3937	0.433
F4024	0.315	0.3937	0.433
F4027	0.315	0.3937	0.433
F4028	0.315	0.3937	0.433

Note: The stripping length is based on the thickness of the insulation wire – more thickness, more stripping length.

Ferrules



Insulated twin ferrules

Diagram	Conductor section				Dimensions in./mm					Installation tool	Pkg. qty.
	Cat. no.	AWG	mm ²	Colour	A	B	øC	øD	E		
	F8000	2 x 20	2 x 0.50	White	0.591 / 15.0	0.315 / 8.0	0.059 / 1.5	0.177 / 4.5	0.010 / 0.25	T3	500
	F8001	2 x 18	2 x 0.75	Grey	0.591 / 15.0	0.315 / 8.0	0.071 / 1.8	0.201 / 5.1	0.006 / 0.15	T3	500
	F8002	2 x 18	2 x 0.75	Grey	0.669 / 17.0	0.394 / 10.0	0.071 / 1.8	0.201 / 5.1	0.006 / 0.15	T3	500
	F8003	2 x 17	2 x 1.00	Red	0.591 / 15.0	0.315 / 8.0	0.081 / 2.05	0.201 / 5.1	0.006 / 0.15	T3	500
	F8005	2 x 17	2 x 1.00	Red	0.669 / 17.0	0.394 / 10.0	0.081 / 2.05	0.201 / 5.1	0.006 / 0.15	T3	500
	F8006	2 x 16	2 x 1.50	Black	0.630 / 16.0	0.315 / 8.0	0.091 / 2.3	0.252 / 6.4	0.006 / 0.15	T3	500
	F8007	2 x 16	2 x 1.50	Black	0.787 / 20.0	0.472 / 12.0	0.091 / 2.3	0.252 / 6.4	0.006 / 0.15	T3	500
	F8008	2 x 14	2 x 2.50	Blue	0.728 / 18.5	0.394 / 10.0	0.114 / 2.9	0.295 / 7.5	0.006 / 0.15	T3	500
	F8009	2 x 14	2 x 2.50	Blue	0.846 / 21.5	0.512 / 13.0	0.114 / 2.9	0.295 / 7.5	0.006 / 0.15	T3	500
	F8010	2 x 12	2 x 4.00	Grey	0.906 / 23.0	0.472 / 12.0	0.150 / 3.8	0.339 / 8.6	0.006 / 0.15	ERG4/ matrice 6 mm	100
	F8011	2 x 10	2 x 6.00	Yellow	0.984 / 25.0	0.551 / 14.0	0.193 / 4.9	0.378 / 9.6	0.008 / 0.20	ERG4/ matrice 10 mm	100

Ferrule dimensions conform to DIN 46228, Part 4



Insulated ferrules (old DIN and French standards)

Diagram	Conductor				Dimensions in./mm					Installation tool	Pkg. qty.	
	Cat. no.	Style	AWG	mm ²	Colour	A	B	øC	øD			E
	F4000	Old DIN	20	0.50	Orange	0.571 / 14.5	0.315 / 8.0	0.043 / 1.1	0.102 / 2.6	0.006 / 0.15	T1, T3 & ERG4	500
	F4001	Old DIN	18	0.75	White	0.571 / 14.5	0.315 / 8.0	0.051 / 1.3	0.110 / 2.8	0.006 / 0.15	T1, T3 & ERG4	500
	F4002	Old DIN	18-17	1.00	Yellow	0.571 / 14.5	0.315 / 8.0	0.059 / 1.5	0.118 / 3.0	0.006 / 0.15	T1, T3 & ERG4	500
	F4003	Old DIN	16	1.50	Red	0.571 / 14.5	0.315 / 8.0	0.071 / 1.8	0.134 / 3.4	0.006 / 0.15	T1, T3 & ERG4	500
	F4020	Old DIN	14	2.50	Blue	0.571 / 14.5	0.315 / 8.0	0.091 / 2.3	0.165 / 4.2	0.006 / 0.15	T1, T3 & ERG4	500
	F4021	French	20	0.50	White	0.571 / 14.5	0.315 / 8.0	0.043 / 1.1	0.102 / 2.6	0.006 / 0.15	T1, T3 & ERG4	500
	F4023	French	18	0.75	Lt. Blue	0.571 / 14.5	0.315 / 8.0	0.051 / 1.3	0.110 / 2.8	0.006 / 0.15	T1, T3 & ERG4	500
	F4024	French	18-17	1.00	Red	0.571 / 14.5	0.315 / 8.0	0.059 / 1.5	0.118 / 3.0	0.006 / 0.15	T1, T3 & ERG4	500
	F4027	French	16	1.50	Black	0.571 / 14.5	0.315 / 8.0	0.071 / 1.8	0.134 / 3.4	0.006 / 0.15	T1, T3 & ERG4	500
	F4028	French	14	2.50	Grey	0.571 / 14.5	0.315 / 8.0	0.091 / 2.3	0.165 / 4.2	0.006 / 0.15	T1, T3 & ERG4	500

Ferrule dimensions conform to DIN 46228, Part 4



T1



T3



ERG4

Tooling for Sta-Kon insulated ferrules

Cat. no.	Description	Pkg. qty.
T1	Sta-Kon crimp tool for wire ferrules #20-#14 AWG - insulated handle	1
T3	Sta-Kon crimp tool for wire ferrules #26-#10 AWG - insulated handle	1
ERG4	Comfort Crimp™ Sta-Kon crimp tool with Shure-Stake mechanism, for installing wire ferrules #26-1/0 AWG. Four interchangeable die sets included. Insulated handle. Packaged in sturdy plastic carrying case.	1

Ferrules



Non-insulated ferrules

Cat. no.	Conductor section		Dimensions in./mm				Installation tooling	Pkg. qty.
	AWG	mm ²	A	C	D	E		
F9000	24	0.25	0.196 / 5	0.030 / 0.75	0.067 / 1.7	0,006 / 0,15	T1, T3, ERG4	1,000
F9001	22	0.5	0.236 / 6	0.039 / 1.0	0.083 / 2.1	0,006 / 0,15	T1, T3, ERG4	1,000
F9002	22	0.5	0.394 / 10	0.039 / 1.0	0.083 / 2.1	0,006 / 0,15	T1, T3, ERG4	1,000
F9003	18	0.75	0.236 / 6	0.047 / 1.2	0.091 / 2.3	0,006 / 0,15	T1, T3, ERG4	1,000
F9004	18	0.75	0.394 / 10	0.047 / 1.2	0.091 / 2.3	0,006 / 0,15	T1, T3, ERG4	1,000
F9005	18	1	0.236 / 6	0.055 / 1.4	0.098 / 2.5	0,006 / 0,15	T1, T3, ERG4	1,000
F9006	18	1	0.394 / 10	0.055 / 1.4	0.098 / 2.5	0,006 / 0,15	T1, T3, ERG4	1,000
F9007	16	1.5	0.276 / 7	0.067 / 1.7	0.110 / 2.8	0,006 / 0,15	T1, T3, ERG4	1,000
F9008	16	1.5	0.394 / 10	0.067 / 1.7	0.110 / 2.8	0,006 / 0,15	T1, T3, ERG4	1,000
F9009	16	1.5	0.473 / 12	0.067 / 1.7	0.110 / 2.8	0,006 / 0,15	T1, T3, ERG4	1,000
F9010	16	1.5	0.709 / 18	0.067 / 1.7	0.110 / 2.8	0,006 / 0,15	T1, T3, ERG4	1,000
F9011	14	2.5	0.276 / 7	0.087 / 2.2	0.139 / 3.4	0,006 / 0,15	T1, T3, ERG4	1,000
F9012	14	2.5	0.394 / 10	0.087 / 2.2	0.139 / 3.4	0,006 / 0,15	T1, T3, ERG4	1,000
F9013	14	2.5	0.472 / 12	0.087 / 2.2	0.139 / 3.4	0,006 / 0,15	T1, T3, ERG4	1,000
F9014	14	2.5	0.709 / 18	0.087 / 2.2	0.139 / 3.4	0,006 / 0,15	T1, T3, ERG4	1,000
F9015	12	4	0.354 / 9	0.110 / 2.8	0.158 / 4	0,008 / 0,2	T3, ERG4	1,000
F9016	12	4	0.472 / 12	0.110 / 2.8	0.158 / 4	0,008 / 0,2	T3, ERG4	1,000
F9017	12	4	0.591 / 15	0.110 / 2.8	0.158 / 4	0,008 / 0,2	T3, ERG4	1,000
F9018	12	4	0.709 / 18	0.110 / 2.8	0.158 / 4	0,008 / 0,2	T3, ERG4	1,000
F9019	10	6	0.472 / 12	0.138 / 3.5	0.185 / 4.7	0,008 / 0,2	T3, ERG4	1,000
F9020	10	6	0.591 / 15	0.138 / 3.5	0.185 / 4.7	0,008 / 0,2	T3, ERG4	1,000
F9021	10	6	0.709 / 18	0.138 / 3.5	0.185 / 4.7	0,008 / 0,2	T3, ERG4	1,000
F9022	8	10	0.472 / 12	0.177 / 4.5	0.228 / 5.8	0,008 / 0,2	ERG4	500
F9023	8	10	0.591 / 15	0.177 / 4.5	0.228 / 5.8	0,008 / 0,2	ERG4	500
F9024	8	10	0.709 / 18	0.177 / 4.5	0.228 / 5.8	0,008 / 0,2	ERG4	500
F9025	6	16	0.472 / 12	0.228 / 5.8	0.295 / 7.5	0,008 / 0,2	ERG4	250
F9026	6	16	0.591 / 15	0.228 / 5.8	0.295 / 7.5	0,008 / 0,2	ERG4	250
F9027	6	16	0.709 / 18	0.228 / 5.8	0.295 / 7.5	0,008 / 0,2	ERG4	250
F9028	6	16	0.984 / 25	0.228 / 5.8	0.295 / 7.5	0,008 / 0,2	ERG4	250
F9029	6	16	1.26 / 32	0.228 / 5.8	0.295 / 7.5	0,008 / 0,2	ERG4	250
F9030	4	25	0.591 / 15	0.287 / 7.3	0.374 / 9.5	0,010 / 0,25	ERG4	100
F9031	4	25	0.709 / 18	0.287 / 7.3	0.374 / 9.5	0,010 / 0,25	ERG4	100
F9032	4	25	0.984 / 25	0.287 / 7.3	0.374 / 9.5	0,010 / 0,25	ERG4	100
F9033	4	25	1.26 / 32	0.287 / 7.3	0.374 / 9.5	0,010 / 0,25	ERG4	100
F9034	2	35	0.709 / 18	0.327 / 8.3	0.433 / 11	0,010 / 0,25	ERG4	100
F9035	2	35	0.984 / 25	0.327 / 8.3	0.433 / 11	0,010 / 0,25	ERG4	100
F9036	2	35	1.26 / 32	0.327 / 8.3	0.433 / 11	0,010 / 0,25	ERG4	100
F9037	1/0	50	0.709 / 18	0.406 / 10.3	0.512 / 13	0,012 / 0,3	TB5095, ERG4	100
F9038	1/0	50	0.984 / 25	0.406 / 10.3	0.512 / 13	0,012 / 0,3	TB5095, ERG4	100
F9039	1/0	50	1.18 / 30	0.406 / 10.3	0.512 / 13	0,012 / 0,3	TB5095, ERG4	100

Diagram

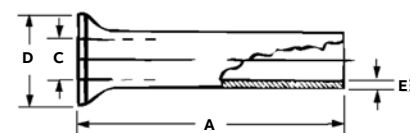

Installing kits

Sta-Kon mini-pack terminals



Convenient 20-count packaging.

- Wire ranges from #22 AWG to #10 AWG
- Vinyl-insulated ring and forked-tongued terminals, female disconnects, butt-type splice connectors

Note: "CP" designates mini-pack quantities. Refer to other catalogue pages for description and dimensional information.

Cat. No.	Unit qty.	Pkg. qty.	Wire range (AWG)	Bolt hole (in.)
18RA-6FCP	20	100	22-18	#6
18RA-8CP	20	100	22-18	#8
18RA-10CP	20	100	22-18	#10
14RB-6CP	20	100	16-14	#6
14RB-8CP	20	100	16-14	#8
14RB-10CP	20	100	16-14	#10
10RC-10CP	20	100	12-10	#10
10RC-14CP	20	100	12-10	¼
18RA-8FCP	20	100	22-18	#8
18RA-10FCP	20	100	22-18	#10
14RB-6FCP	20	100	16-14	#6
14RB-8FCP	20	100	16-14	#8
14RB-10FCP	20	100	16-14	#10
10RC-8FCP	20	100	12-10	#8
10RC-10FCP	20	100	12-10	10
2RA18XCP	20	100	22-18	-
2RB14XCP	20	100	16-14	-
2RC10XCP	20	100	12-10	-
18RA-250FCP	20	100	22-18	-
14RB-250FCP	20	100	16-14	-
10RC-250FCP	20	100	12-10	-

Installing kits

Sta-Org™ terminal and splice organizer kit



Lightweight, durable, nylon construction.

- Ideal for contractors, OEMs or any other user of terminals and splices
- Slips in a tool box or sits on your bench — only 6.6 in. L x 3 in. dia.
- Bench-mountable (hardware included)
- Kit contents
 - (1) blue nylon organizer/carrier
 - (6) see-through nylon canisters with lids
 - (20) #12–#10 AWG vinyl ring terminals (cat. no. 10RC-10)
 - (25) #18–#14 AWG vinyl ring terminals (cat. no. 14RB-10)
 - (15) #12–#10 AWG vinyl butt splices (cat. no. 2RC-10X)
 - (25) #18–#14 AWG vinyl butt splices (cat. no. 2RB-14X)
 - (20) #12–#10 AWG vinyl fork terminals (cat. no. 10RC-10F)
 - (25) #18–#14 AWG vinyl fork terminals (cat. no. 14RB-10F)

Cat. No.	Description	Pkg. Qty.
STA-ORG	Sta-Kon Sta-Org terminal and splice organizer kit	1

Installing kits

Terminal kits

For residential or light commercial installations, we recommend this proven assortment of popular Sta-Kon vinyl terminals. This kit includes a WT112M crimping tool.



Kit contains:

- 36 2RA18X butt splices for 22–16 AWG
- 36 18RA-8F fork terminals for 22–16 AWG
- 36 18RA-10F fork terminals for 22–16 AWG
- 36 18RA-8 ring terminals for 22–16 AWG
- 36 18RA-10 ring terminals for 22–16 AWG
- 36 2RB14X butt splices for 16–14 AWG
- 36 14RB-10F fork terminals for 18–14 AWG
- 36 14RB-250F disconnects for 22–18 AWG
- 36 14RB-8F fork terminals for 18–14 AWG
- 36 14RB-8 ring terminals for 18–14 AWG
- 36 14RB-10 ring terminals for 18–14 AWG
- 25 2RC10X butt splices for 12–10 AWG
- 25 10RC-8F fork terminals for 12–10 AWG
- 25 10RC-10 ring terminals for 12–10 AWG
- 20 RC55 wire joints
- 1 WT112M crimping tool
- 50 PRO-BLU 933 wire connector, blue, for 22–8 AWG

Terminal kit

Cat. no.	Description	Pkg. qty.
SK-CLASSIQUE	Terminal kit	1

Perfect for residential or light commercial installations.

- Assortment of popular Sta-Kon vinyl terminals
- Kit includes a WT112M crimping tool
- Includes cable ties and wire marker book



Kit contains:

- 100 2RA18X butt splices for 22–18 AWG
- 100 2RB14X butt splices for 18–14 AWG
- 50 2RC10X butt splices for 12–10 AWG
- 50 10RC-10 ring terminals for 12–10 AWG
- 50 10RC-10FL locking fork terminals for 12–10 AWG
- 50 10RC-250F disconnects for 12–10 AWG
- 100 14RB-10 ring terminals for 18–14 AWG
- 100 14RB-8FL locking fork terminals for 18–14 AWG
- 100 14RB-250F disconnects for 18–14 AWG
- 100 18RA-8F fork terminals for 22–18 AWG
- 100 18RA-6FL locking fork terminals for 22–18 AWG
- 100 18RA-250F disconnects for 22–18 AWG
- 1 WM-0-THRU9 wire marker book
- 1 WT112M crimping tool
- 100 TY525M Ty-Rap® cable ties (approx. length 7½)

Note: All splices, terminals and disconnects are vinyl insulated.

Sta-Kit installing kit

Cat. no.	Description	Pkg. qty.
STAKIT	Assortment of Sta-Kon vinyl terminals, splices and disconnects. Includes crimp tool, cable ties and wire book marker.	1

Application tools

Recommended tools

- 01 WT112M
- 02 ERG4001
- 03 12050



The Shure-Stake mechanism on mechanical ratchet tools and power tools prevents the dies from releasing the terminal until the proper compression has been completed. With this method, an operator achieves a reliable crimp every time. ABB tooling techniques correctly match tools, wire size and terminal to produce optimum mechanical and electrical performance.

Plier-type if installations are fewer than 20 per day



— 01

Ratchet-type if installations are more than 20 per day



— 02

Power-type if installations are more than 200 per day



— 03

Plier-type tools

Cat. no.	For use with Sta-Kon series	Pkg. qty.
WT110M	A, B, C non-insulated terminals and splices and A, B non-insulated terminals with insulation grip	1
WT111M	A, B, C, PT non-insulated terminals and splices; includes cutters	1
WT112M	A, B, C non-insulated and RA, RB, RC insulated nylon and vinyl terminals and splices; includes cutters	1
WT161M	A, B, C, PT non-insulated terminals and splices; includes plier grip and cutters	1
WT2000	A, B, C, AB, PT, RA, RB, RC insulated and non-insulated terminals and splices; includes wire cutters, bolt cutters and wire stripper	1

- 04 WT110M
- 05 WT111M
- 06 WT112M
- 07 WT161M
- 08 WT2000



— 04



— 05



— 06



— 07



— 08

Application tools

The proper installation procedure for the quality-assured connection.

—
01 ERG4001
Shure-Stake tools are
matched to terminals

The proper installation of terminals, splices and connectors is very important to the efficient performance of an electrical system. The properly installed connector will enable good conductivity through the termination. Certain basic requirements must be met to make a good termination.

- Strip the insulation carefully to avoid nicking or cutting conductor strands
- Strip the insulation to the proper length so the conductors can be inserted fully into the connector barrel; the wire/cable should be visible in the inspection hole of the lug

A poor termination results in a high-resistance connection. A poor connector installation may cause damage or failure of an entire system.

Safety warning: Keep fingers and hands away from mechanism during crimp function.

Installation procedure

- Strip the insulation carefully to avoid nicking or cutting conductor strands.
- Strip the insulation to the proper length so the conductors can be inserted fully into the connector barrel; the wire/cable should be visible in the inspection hole of the lug.
- Train the wires to eliminate fanning of strands.
- Open handles fully.
- Insert terminal in proper die nest and locate it as shown below. When crimping a butt splice, position in proper die nest with window facing indenter.
- Close handles slightly to secure terminal. Do not deform terminal.
- Insert properly stripped wire into terminal.
- Complete crimp by closing handles.



—
01

Diagram

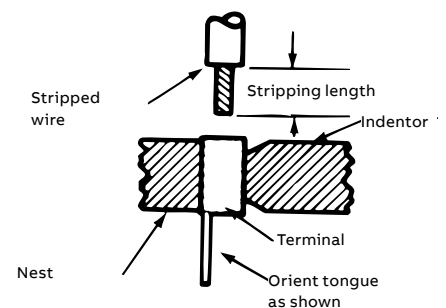

Application tools

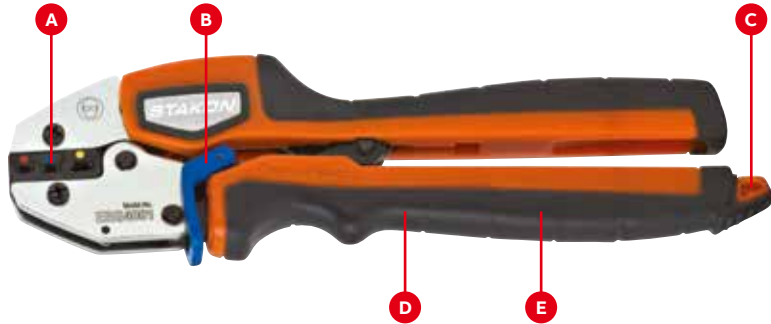

A Colour-coded die nests (left and right side) provided for proper crimping of insulated terminals

B Shure-Stake mechanism ensures a proper crimp every time

C Crimp-Assist foot provides stability when work surface leverage is needed to crimp larger connectors

D Ergonomically advanced, soft, over-molded handle grips reduce strain and enhance user comfort

E Requires one of the lowest handle forces of any tooling in its class – 25% less than the previous generation of Comfort Crimp tools

Redesigned family of termination tools sets a new standard for manual crimping tools. The most comfortable crimp available from a manual compression tool.





Sta-Kon Comfort Crimp compression tools previously set the standard for manual crimp tools. Now, ABB engineers have made a great line of tools even better with the newly redesigned Sta-Kon Comfort Crimp compression tools. We kept all the performance features that made the tools industry leaders, such as the Shure-Stake mechanism and interchangeable dies with colour-coded die nests, and focused on creating the best possible user experience in terms of comfort and reduction of strain.

Ergonomic handles position the user’s hands correctly to minimize the risk of strain, and soft, over-molded grips cushion fingers and palm for user comfort. A new Crimp-Assist™ foot stabilizes the tool when the user needs to place it on a work surface for leverage to crimp larger connectors. Best of all, the redesigned Comfort Crimp tools require 25% less handle force to complete the crimp cycle than the previous generation — and up to 75% less handle force than competing tools.

Requiring one of the lowest handle forces of any tool in its class, the Comfort Crimp tool family provides maximum comfort to installers, without sacrificing the durability or performance associated with ABB tools.

- Perfect for OEM, MRO and field use
- UL Listed for use with Sta-Kon connectors
- Shure-Stake mechanism ensures a complete crimp cycle before release for a proper crimp every time
- Colour-coded die nests for easy matching with Sta-Kon insulated terminals
- Creates integrity dots for quick verification of proper crimp
- Advanced manufacturing methods for improved durability and tool life
- Lanyard hole in handle for easy tethering to workstation
- Calibration service available through ABB Tool Services

Comfort Crimp compression tools

	Cat. no.	For use with Sta-Kon series	Pkg. qty.
	ERG4001	RA, RB, RC nylon & vinyl terminals, splices & disconnects	1
	ERG4002	A, B, C non-insulated terminals, splices, disconnects	1
	ERG4004	A, B and C flag terminals	1
	ERG4005	B, C, D, E non-insulated terminals, splices (D & E tubular only)	1
	ERG4006	RA, RB disconnects and RZ terminals	1
	ERG4007	RD & RE insulated terminals (tubular only)	1
	ERG4008	Non-insulated terminals #8–1/0 AWG (tubular only)	1

Note: Contact tool services for gauging

Application tools



WT1377 ratchet hand tool

Cat. no.	For use with Sta-Kon series	Pkg. qty.
WT1377	NW ring terminals	1

Correct compression every time — the Shure-Stake mechanism principle prevents opening of the handles until full staking action is completed. Installs self-insulated and non-insulated Sta-Kon terminal series in the #26–#10 AWG wire range.



WT2130A ratchet hand tool

Cat. no.	For use with Sta-Kon series	Pkg. qty.
WT2130A	RC, RBC and RD insulated terminals, RC6, RP7 wire joints	1



ERG4006 hand tool

Cat. no.	For use with Sta-Kon series	Pkg. qty.
ERG4006	RZ terminals/splices RA, RB insulated disconnects	1



WT3185 ratchet hand tool

Cat. no.	For use with Sta-Kon series	Pkg. qty.
WT3185	For #8 AWG to 250 kcmil non-insulated Sta-Kon terminals	1

Note: For gauging information, contact Tool Services



ERG4255 ratchet hand tool

Cat. no.	For use with Sta-Kon series	Pkg. qty.
ERG4255	RA, RB, RC heat-shrinkable nylon-insulated terminals, butt splices and disconnects	1



WT129 flag terminal type hand tool

Cat. no.	For use with Sta-Kon series	Pkg. qty.
WT129	D, E, F & G non-insulated flag terminals	1

Application tools

01 ERG1-WS
02 "V" Blade cassette



Integral wire cutter lets user cut and strip with the same tool.

- Interchangeable cassettes enable the user to strip a wide range of insulations without having to change tools
- Tool automatically strips wire to preset length

Sta-Kon ERG1-WS Wire stripping/cutting tool

Cat. no.	Description	Pkg. qty.
ERG1-WS	Ergonomic wire stripping tool	1
VBC-1	Replacement "V" blade cassette	1

ERG1-WS Wire stripping/cutting tool is shipped with one straight blade cassette (SBC-1).
"V" Blade cassettes sold separately.



WT115A Toggle-type hand tool

Cat. no.	For use with Sta-Kon series	Pkg. qty.
WT115A	D, E, F & G non-insulated terminals	1



03 TBM6

03

TBM6 and TBM6S Toggle-type hand tools

Cat. no.	For use with Sta-Kon series	Pkg. qty.
TBM6	D through M, RD through RM	1
TBM6S	D through M, RD through RM with Shure-Stake	1

Dies not included.
Note: These tools can also be used to crimp Blackburn® lugs and splices.

Installing dies for non-insulated code and aircraft Sta-Kon terminals

Cat. no.	Nest stationary die	Indentor movable die	Term. Size
11803		-	D, E (tubular)
11805		-	E (brazed), F (tubular)
11806	11802-TB		F (brazed), G
11807-TB		-	H
11808		-	J
11809		-	K
11810-TB		-	L
11811		-	M

Installing dies for nylon-insulated Sta-Kon terminals

Die set cat. no.	Term. size
11821	RD (tubular)
11822	RD (brazed seam) RE (tubular)
11823	RF
11824	RG
11825	RH
11826	RJ
11827	RK
11828	RL
11829	RM

Application tools

Shure-Stake auto-feed tool



Safe, fast, high-volume crimping machine.

- Shure-Stake mechanism
- Fully guarded foot pedal
- Clear plastic safety guard over die area
- Dies colour-coded to terminals
- #26–#10 AWG wire range
- Installs insulated and non-insulated terminals and disconnects

Installing dies for 12050

Cat. no.	Description	Pkg. qty.
12050	Compact, pneumatically operated unit for crimping tape-mounted Sta-Kon terminals; equipped with a Shure-Stake mechanism, which ensures a full compression each time	1

Space requirement: 30 in. W x 20 in. H x 20 in. D

Weight: 55 lb

Air pressure: 90–125 psi input air supply

Die cat. no.	Sta-Kon terminal type	Wire size (AWG)	Pkg. qty.
12051	RA — Nylon	22–18	1
12054*	RA — Vinyl	22–18	1
12061	RA — Disconnect	22–18	1
12052	RB — Nylon	16–14	1
12055*	RB — Vinyl	16–14	1
12062	RB — Disconnect	16–14	1
12056	RC — Nylon and vinyl insulated	12–10	1
12057	A — Non-insulated	22–18	1
12058	B — Non-insulated	16–14	1
12059	C — Non-insulated	12–10	1
12060	C — Disconnect, non-insulated	12–10	1

* Can also be used on nylon

Application tools

BAT22-6NV2 Battery-powered crimping tool



The Sta-Kon BAT22-6NV2 is motorized and automatic for effortless, single-lever crimping.

This is an excellent tool for various markets including panel builders, system integrators, data centers, utilities and various other OEM and MRO applications.

The lightweight, ergonomic design minimizes the risk of repetitive motion injuries that can occur with traditional hand crimping tools.

- 150,000 cycle lifespan
- Extremely light and efficient
- Crimps both Sta-Kon and Dragon Tooth terminals

- Comes complete with extra battery, charger and carrying case
- Powerful lithium-ion battery with charge-level indicator
- Single-lever motorized operation for easy manual preclamping, automatic crimping and auto-retract functions
- Motor-stall protection in case of faulty operation
- LED work light illuminates work areas

Included accessories

- Sturdy, plastic carrying case for portability
- Two 10.8 V lithium-ion batteries and charger
- Sturdy tray for convenient storage of crimp dies



Installing dies for BAT22-6NV2



Cat. no.	Description	Pkg. qty.
BAT22-6NV2	Battery-powered crimping tool with two 10.8 V lithium-ion batteries	1
Die sets*		
DIE2001	Sta-Kon insulated 22–10 AWG terminals	1
DIE2002	Sta-Kon non-insulated 22–10 AWG terminals	1
DIE2005	Sta-Kon non-insulated 16–14, 12–10, 8–6 AWG tubular terminals	1
DIE2007	Sta-Kon insulated 8–6 AWG tubular terminals	1
DIE2009	Sta-Kon wire joints RB, RC, RP series 22–10	1
DIE2500	Spec-Kon™ insulated 22–10 AWG terminals	1
DIE1806**	Dragon Tooth terminals 22F, L, R–6 series	1

*Dies sold separately.

** DIE1806 is not CSA certified or UL Listed.

Application tools

PAIR22-6 Air crimp tool



Heavy-duty portable tool.

- 1.25 tons output force at 100 psi
- Crimps #22–#6 AWG terminals
- Installs Sta-Kon terminals as well as ferrules and Dragon Tooth™ connectors
- Interchangeable dies
- Open yoke enables easy access to insert and remove terminals for crimping

Installing dies for PAIR22-6

Cat. no.	Description	Pkg. qty.
PAIR22-6	Open yoke, hand-actuated air crimp tool	1
Crimp dies*		
DIE2001	Insulated #22–#10 AWG Sta-Kon terminals	1
DIE2002	Non-Insulated #22–#10 AWG Sta-Kon terminals	1
DIE2005	Non-insulated #16–#10/#8–#6 Sta-Kon terminals (tubular only)	1
DIE2007	Insulated #8–#6 AWG Sta-Kon terminals (tubular only)	1

* Dies sold separately.

Note: The dies for the BAIR22-6, PAIR22-6 and BAT22-6 are interchangeable.

Note: Battery-powered tools BPI42300CR, BPLT6BSCR and BPLT62BSCR can also be used to crimp non-insulated Sta-Kon terminals.

Application tools

Bench-mounted air tools



BAIR22-6 Bench-mounted air tool

Crimps #22–#6 AWG terminals.

- 1.8 tons output force at 100 psi
- Bench-mounted heavy-duty air tool
- Short cycle time
- Shure-Stake mechanism
- Foot actuated
- Accepts ABB standard hand tool dies
- Installs Sta-Kon and Spec-Kon terminals, as well as ferrules and Dragon Tooth connectors

Cat. no.	Description	Pkg. qty.
BAIR22-6	Heavy-duty, high-speed production tool installs a wide range of Sta-Kon terminals, from #26–#6 AWG; uses the DIE2000 series dies for both non-insulated and insulated terminals; supplied complete with foot pedal, air hose/air lubricator	1
Crimp dies*		
DIE2001	Insulated #22–#10 AWG Sta-Kon terminals	1
DIE2002	Non-Insulated #22–#10 AWG Sta-Kon terminals	1
DIE2005	Non-Insulated #16–#10/#8–#6 Sta-Kon terminals (tubular only)	1
DIE2007	Insulated #8–#6 AWG Sta-Kon terminals (tubular only)	1

* Dies sold separately.

Note: The dies for the BAIR22-6, PAIR22-6 and BAT22-6 are interchangeable.

Note: Battery-powered tools BPI42300CR, BPLT6BSCR and BPLT62BSCR can also be used to crimp non-insulated Sta-Kon terminals.



Crimps #8 AWG–250 kcmil.

Convenience and economy

The tool accepts a full range of interchangeable dies, the same as used in the TBM6 or TBM6S tools. To install the dies, simply pull the spring-loaded pin and remove the indentor die. Then, flex the retaining spring and remove the die nest.

Shure-Stake mechanism means quality connections

The Shure-Stake mechanism senses inlet air pressure, and if insufficient, is designed to prevent the tool from cycling. Thus you avoid “under-crimping.” An 85–90-psi air pressure source is required.

Safety features increase productivity, reduce downtime

Safety features include a guard over the die area, an air shutdown switch activated by a slight push with the finger and a foot pedal that’s enclosed to prevent accidental tool operation. In addition, the tool may be bench-mounted for stability and control. For convenience when crimping large size terminals on heavy wire, the head assembly may overhang the workbench.

Air-operated bench-mounted tool

Cat. no.	Description	Pkg. qty.
25000	This compact heavy-duty air tool installs nylon insulated Sta-Kon terminals on wire sizes from #8 AWG to 250 kcmil; non-insulated styles are also installed just as quickly and dependably; heavy-duty air tool installs non-insulated and insulated Sta-Kon terminals from #8 AWG to 250 kcmil	1

Note: This tool uses the same dies as the TBM6 and TBM6S hand tools on page 60.

Application Tools

Hydraulic heads



Installs insulated and non-insulated Sta-Kon terminals!

12-Ton hydraulic head

Cat. no.	Description	Pkg. qty.
13400	12-ton crimping tool supplied with adapter TBM12D-AR; used for installing both insulated and non-insulated Sta-Kon terminals #8 AWG to 250 kcmil (dies ordered separately)	1



Military listed and 12 tons of crimping power.

12-Ton crimping tool (military spec. MS25441-1)

Cat. no.	Description	Pkg. qty.
13642M	Hydraulic-operated 12-ton tool; installs #8 AWG to 250 kcmil Sta-Kon terminals (dies ordered separately)	1

Diagram

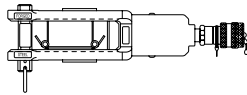

Hex dies for non-insulated Sta-Kon terminals to fit 13642M and 13400

Cat. no.	For tubular term	For brazed seam	Sta-Kon size	Wire size (AWG)	Hex die code
11732	—	—	D	8	21
—	11733	—	D	8	24
11733	—	—	E	6	24
—	11734	—	E	6	29
11734	—	—	F	4	29
—	11735	—	F	4	33
11736	—	—	G	2-1	37
11737	—	—	H	1/0	42
11738	—	—	J	2/0	45
11739	—	—	K	3/0	50
11740	—	—	L	4/0	54
11771	—	—	M	250 kcmil	62

Hex dies for non-insulated Sta-Kon terminals to fit 13642M (military listed)

Die cat. no.	Sta-Kon size	Wire size (AWG)	Pkg. qty.
11781M	D	8	1
11782M	E	6AN	1
11783M	F	4AN	1
11784M	G	2AN	1
11785M	H	1AN	1
11786M	J	1/0AN	1
11787M	K	2/0AN	1
11788M	L	3/0AN	1
11789M	M	4/0AN	1

Installing dies for insulated Sta-Kon terminals to fit 13642M (military listed)

Die cat. no.	Sta-Kon size	Wire size (AWG)	Pkg. qty.
21707M	RD	8	1
21708M	RE	6	1
21709M	RF	4	1
21710M	RG	2-1	1
21711M	RH	1/0	1
21712M	RJ	2/0	1
21713M	RK	3/0	1
21714M	RL	4/0	1
21715M	RM	250 kcmil	1

Indent-style dies for Sta-Kon brazed seam non-insulated terminals to fit 13642M and 13400

Nest cat. no.	Indent. cat. no.	Sta-Kon size	Wire size (AWG)	Pkg. qty.
13643	13650	D	8	1
13644	13650	E	6	1
13645	13650	F	4	1

Indent-style dies for Sta-Kon tubular non-insulated terminals to fit 13642M and 13400

Nest Cat. No.	Indent. cat. no.	Sta-Kon size	Wire size (AWG)	Pkg. qty.
13654	13650	G	2-1	1
13655	13650	H	1/0	1
13656	13650	J	2/0	1
13657	13650	K	3/0	1
13658	13650	L	4/0	1
13659	13650	M	250 kcmil	1

Indent-style dies for flag type Sta-Kon terminals — use with 13642M and 13400

Nest cat. no.	Indent. cat. no.	Sta-Kon size	Wire size (AWG)	Pkg. qty.
21733	21731	D	8	1
21734	21731	E	6	1
21735	21731	F	4	1
21736	21732	G	2	1
21737	21732	H	1	1
21738	21732	J	1/0	1
21739**	21732	K	2/0	1
21740**	21732	L	3/0	1
21741**	21732	M	4/0	1

** Cat. nos. 21739, 21740 and 21741 dies must be left in 13642M head with 21732 indenter when gauging

Application tools

Hydraulic pumps



- Designed for use with single-acting cylinders and tools rated for 10,000-psi operation
- Supplied with metal carrying case
- 13620 hand switch and 13619 hydraulic hose, both sold separately, required for operation

Specifications

- Motor: ½ hp, 115 V 50–60 Hz, 10 amps
- Pumping Capacity:
 - 170 cu. in./min. at 100 psi
 - 32 cu. in./min. at 1,000 psi
 - 25 cu. in./min. at 5,000 psi
 - 18 cu. in./min. at 10,000 psi
- Reservoir volume: 104 cu. in. (0.45 gal.)
- Basic pump dimension: 6 in. x 8 in. x 16 in.
- Weight: 25 lb

13600 Electric hydraulic pump

Cat. no.	Description	Pkg. qty.
13600	Electric hydraulic pump – hand or foot switch and non-metallic hose (sold separately) required for operation	1



- Shure-Stake control mechanism requires 9,800-psi pump pressure before recycling to prevent under-crimping
- Designed for use with single-acting cylinders and tools rated for 10,000-psi operation
- Supplied with metal carrying case

Specifications

- Motor rating: ½ hp, 115 V, 50–60 Hz, 12.5 amps
- Pumping capacity:
 - 170 cu. in./min. at 100 psi
 - 32 cu. in./min. at 1,000 psi
 - 25 cu. in./min. at 5,000 psi
 - 18 cu. in./min. at 10,000 psi
- Reservoir volume: 104 cu. in. (0.45 gal.)
- Basic pump dimension: 8½ in. x 10½ in. x 16 in.
- Weight: 35 lb

13610A Electric hydraulic pump with Shure-Stake control

Cat. no.	Description	Pkg. qty.
13610A	Electric hydraulic pump with Shure-Stake control – hand or foot switch and non-metallic hose (sold separately) required for operation	1

Application tools

Hydraulic pumps



- Designed for perfect crimps every time in heavy-duty OEM applications
- Heavy-duty OEM two-stage pump with high flow rate
- Shure-Stake control mechanism requires 9,800-psi pump pressure before recycling to prevent under-crimping
- Requires hand or foot control (sold separately)

Specifications

- Motor rating: 1½ hp, 115 V, 60 Hz, 23 amps
- Pumping capacity:
235 cu.in./min. at 200 psi
6 cu.in./min. at 8,000 psi
- Reservoir volume: 462 cu.in./2 gal.
- Dimensions (L x W x H): 10¾ in. x 15 in. x 20¾ in.
- Weight: 60 lb

13810 Heavy-duty electric hydraulic pump with Shure-Stake control

Cat. no.	Description	Pkg. qty.
13810	Heavy-duty electric hydraulic pump with Shure-Stake control – hand or foot switch and non-metallic hose (sold separately) required for operation	1

Accessories for electric hydraulic pumps

Cat. no.	Description	Pkg. qty.
For 13600		
13620	Hand switch	1
13589A	Foot switch	1
13619	10-ft. Non-metallic hose	1
13618	20-ft. Non-metallic hose	1
13600S	“Sled” type stand for 13600 pump	1
For 13610A and 13810		
13611	Hand switch	1
13612	Foot switch	1
13619	10-ft. Non-metallic hose	1

Die selection chart

Critical information for determining the products you need.

Product selection guide

Type	Terminal series	Pliers					Ergonomic ratchet hand tools						Ratchet hand tools			
		WT110M	WT111M	WT112M	WT161M	WT2000	ERG4001	ERG4002	ERG4004	ERG4005	ERG4006	ERG4255	WT1377	WT145A	WT145C	WT2130A
Nylon terminals	RZ	-	-	-	-	-	-	-	-	-	•	-	-	-	-	-
	RA, RAX	-	-	•	-	•	•	-	-	-	-	-	-	•	•	-
	RB	-	-	•	-	•	•	-	-	-	-	-	-	•	•	-
	RBC, RC	-	-	•	-	•	•	-	-	-	-	-	-	•	•	•
Nylon butt splices	RA	-	-	•	-	•	•	-	-	-	-	-	-	-	•	-
	RB	-	-	•	-	•	•	-	-	-	-	-	-	-	•	-
	RC	-	-	•	-	•	•	-	-	-	-	-	-	-	•	•
Nylon parallel splices	RAA	-	-	-	-	•	-	-	-	-	-	-	-	-	-	-
	RBB	-	-	-	-	•	-	-	-	-	-	-	-	-	-	-
	RCC	-	-	-	-	•	-	-	-	-	-	-	-	-	-	-
All nylon disconnects (except 0.110 size)	RA	-	-	•	-	•	•	-	-	-	-	-	-	-	•	-
	RB	-	-	•	-	•	•	-	-	-	-	-	-	-	•	-
	RC	-	-	•	-	•	•	-	-	-	-	-	-	-	•	•
Heat-shrinkable terminals, splices & disconnects	RAS	-	-	-	-	-	-	-	-	-	-	•	-	-	-	-
	RBS	-	-	-	-	-	-	-	-	-	-	•	-	-	-	-
	RCS	-	-	-	-	-	-	-	-	-	-	•	-	-	-	-
Vinyl terminals and splices	RA, RAA	-	-	•	-	•	•	-	-	-	-	-	-	-	•	-
	RB, RBB	-	-	•	-	•	•	-	-	-	-	-	-	-	•	-
	RC, RCC, RBC	-	-	•	-	•	•	-	-	-	-	-	-	-	•	•
Bare terminals and splices	A, AA	•	•	•	•	•	-	•	-	-	-	-	-	-	-	-
	B, BB	•	•	•	•	•	-	•	-	•	-	-	-	-	-	-
	C, CC	•	•	•	•	•	-	•	-	•	-	-	-	-	-	-
Wire joints	RB	-	-	•	-	•	•	-	-	-	-	-	-	-	-	•
	RC	-	-	•	-	•	-	-	-	-	-	-	-	-	•	-
	RP	-	-	•	-	•	-	-	-	-	-	-	-	-	•	-
	PT	-	•	-	•	-	-	-	-	-	-	-	-	-	-	-
Hi-temp terminals and splices	NW-rings	-	-	-	-	-	-	-	-	-	-	-	•	-	-	-
	NW-splices	-	-	-	-	-	-	-	-	-	-	-	•	-	-	-
Insulation grip	A	•	-	-	-	-	-	-	-	-	-	-	-	-	-	-
	B	•	-	-	-	-	-	-	-	-	-	-	-	-	-	-
0.110 disconnects	A, B	•	•	•	-	-	-	-	-	-	-	-	-	-	-	-
	RA, RB	-	-	-	-	-	-	-	-	-	•	-	-	-	-	-
Flag terminals	AB	-	-	-	-	-	-	-	•	-	-	-	-	-	-	-
	C	-	-	-	-	-	-	-	•	-	-	-	-	-	-	-
Tefzel terminals and splices	RAT, RAAT	-	-	•	-	•	-	-	-	-	-	-	-	-	•	-
	RB, RBBT	-	-	•	-	•	-	-	-	-	-	-	-	-	•	-
	RC, RCCT	-	-	•	-	•	-	-	-	-	-	-	-	-	•	-
Vinyl disconnects	RA	-	-	•	-	•	•	-	-	-	-	-	-	-	•	-
	RB	-	-	•	-	•	•	-	-	-	-	-	-	-	•	-
	RC	-	-	•	-	•	•	-	-	-	-	-	-	-	•	•
Bare disconnects	A	•	•	•	•	•	-	•	-	-	-	-	-	-	-	-
	B	•	•	•	•	•	-	•	-	•	-	-	-	-	-	-
	C	•	•	•	•	•	-	•	-	•	-	-	-	-	-	-

Tefzel is a registered trademark of DuPont.

Die selection chart

Critical information for determining the products you need.

Product selection guide

Type	Terminal series	BAT22-6NV2 / BAIR22-6/ PAIR22-6				12050 Mylar tape auto tool								
		DIE2001	DIE2002	DIE2005	DIE2009	12051	12052	12054	12055	12056	12057	12058	12059	12060
Nylon terminals	RZ	-	-	-	-	-	-	-	-	-	-	-	-	-
	RA, RAX	•	-	-	-	•	-	•	-	-	-	-	-	-
	RB	•	-	-	-	-	•	-	•	-	-	-	-	-
	RBC, RC	•	-	-	-	-	-	-	-	•	-	-	-	-
Nylon butt splices	RA	•	-	-	-	-	-	-	-	-	-	-	-	-
	RB	•	-	-	-	-	-	-	-	-	-	-	-	-
	RC	•	-	-	-	-	-	-	-	-	-	-	-	-
Nylon parallel splices	RAA	-	-	-	-	-	-	-	-	-	-	-	-	-
	RBB	-	-	-	-	-	-	-	-	-	-	-	-	-
	RCC	-	-	-	-	-	-	-	-	-	-	-	-	-
All nylon disconnects (except 0.110 size)	RA	•	-	-	-	•	-	•	-	-	-	-	-	-
	RB	•	-	-	-	-	•	-	•	-	-	-	-	-
	RC	•	-	-	-	-	-	-	-	•	-	-	-	-
Heat-shrinkable terminals, splices & disconnects	RAS	-	-	-	-	-	-	-	-	-	-	-	-	-
	RBS	-	-	-	-	-	-	-	-	-	-	-	-	-
	RCS	-	-	-	-	-	-	-	-	-	-	-	-	-
Vinyl terminals and splices	RA, RAA	•	-	-	-	-	-	•	-	-	-	-	-	-
	RB, RBB	•	-	-	-	-	-	-	•	-	-	-	-	-
	RC, RCC, RBC	•	-	-	-	-	-	-	-	•	-	-	-	-
Bare terminals and splices	A, AA	-	•	-	-	-	-	-	-	-	•	-	-	-
	B, BB	-	•	•	-	-	-	-	-	-	-	•	-	-
	C, CC	-	•	•	-	-	-	-	-	-	-	-	•	-
Wire joints	RB	•	-	-	•	-	-	-	-	-	-	-	-	-
	RC	-	-	-	•	-	-	-	-	-	-	-	-	-
	RP	-	-	-	•	-	-	-	-	-	-	-	-	-
	PT	-	-	-	-	-	-	-	-	-	-	-	-	-
Hi-temp terminals and splices	NW-rings	-	-	-	-	-	-	-	-	-	-	-	-	-
	NW-splices	-	-	-	-	-	-	-	-	-	-	-	-	-
Insulation grip	A	-	-	-	-	-	-	-	-	-	-	-	-	-
	B	-	-	-	-	-	-	-	-	-	-	-	-	-
0.110 disconnects	A, B	-	-	-	-	-	-	-	-	-	-	-	-	-
	RA, RB	-	-	-	-	-	-	-	-	-	-	-	-	-
Flag terminals	AB	-	-	-	-	-	-	-	-	-	-	-	-	-
	C	-	-	-	-	-	-	-	-	-	-	-	-	-
Tefzel terminals and splices	RAT, RAAT	-	-	-	-	-	-	-	-	-	-	-	-	-
	RB, RBBT	-	-	-	-	-	-	-	-	-	-	-	-	-
	RC, RCCT	-	-	-	-	-	-	-	-	-	-	-	-	-
Vinyl disconnects	RA	•	-	-	-	-	-	•	-	-	-	-	-	-
	RB	•	-	-	-	-	-	-	•	-	-	-	-	-
	RC	•	-	-	-	-	-	-	-	•	-	-	-	-
Bare disconnects	A	-	•	-	-	-	-	-	-	-	•	-	-	-
	B	-	•	•	-	-	-	-	-	-	-	•	-	-
	C	-	•	•	-	-	-	-	-	-	-	-	-	•

Tefzel is a registered trademark of DuPont.

Die selection chart

Select the die numbers you need.

Terminal Description	Series	Type	TBM6 toggle hand tool TBM6S toggle hand tool die Cat. nos.			BPI42300CR, BPLT6BSCR and BPLT62BSCR crimp tools		13642M (MS25441-1) and 13400 hydraulic tool		
			Hand tool with dies	Nest (stationary)	Indentor (movable)	Hex dies	Die code	Hex dies	Nest	Indentor
Non-insulated terminals and splices	D	Tubular	ERG4005	11803	11802-TB	—	—	11781M*	13651	13650**
	D	Tubular	ERG4008	11803	11802-TB	—	—	11781M*	13651	13650**
	D	Tubular	WT3185/WT115A	11803	11802-TB	TBM6221	21	11732	13651	13650**
	D	Brazed	WT3185/WT115A	11803	11802-TB	TBM6224	24	11733	13643	13650**
	E	Tubular	ERG4005	11803	11802-TB	—	—	11782M	13652	13650**
	E	Tubular	ERG4008	11803	11802-TB	—	—	11782M	13652	13650**
	E	Tubular	WT3185/WT115A	11803	11802-TB	TBM6224	24	11733*	13652	13650**
	E	Brazed	WT3185/WT115A	11804	11802-TB	TBM6229	29	11734	13644	13650**
	F	Tubular	ERG4008	11805	11802-TB	—	—	11783	13653	13650**
	F	Tubular	WT3185/WT115A	11805	11802-TB	TBM6229	29	11734*	13653	13650**
	F	Brazed	WT3185/WT115A	11806	11802-TB	TBM6233	33	11735	13645	13650**
	G	Tubular	ERG4008	11806	11802-TB	—	—	11784M*	13654	13650**
	G	Tubular	WT3185/WT115A	11806	11802-TB	TBM6237	37	11736	13654	13650**
	H	Tubular	ERG4008	11807-TB	11802-TB	—	—	11785M*	13655	13650**
	H	Tubular	WT3185	11807-TB	11802-TB	—	—	11785M*	13655	13650**
	H	Tubular	WT3185	11807-TB	11802-TB	TBM6242	42	11737	13655	13650**
	J	Tubular	WT3185	11808	11802-TB	—	—	11786M*	13656	13650**
	J	Tubular	WT3185	11808	11802-TB	TBM6245	45	11738	13656	13650**
	K	Tubular	—	11809	11802-TB	—	—	11787M*	13657	13650**
	K	Tubular	—	11809	11802-TB	TBM6250	50	11739	13657	13650**
L	Tubular	—	11810-TB	11802-TB	—	50	11788M*	13658	13650**	
L	Tubular	—	11810-TB	11802-TB	TBM6254	54	11740	13658	13650**	
M	Tubular	—	11811	11802-TB	—	54	11789M*	13659	13650**	
M	Tubular	—	11811	11802-TB	TBM6262	62	11771	13659	13650**	
Tefzel ¹ nylon insulated terminals and splices	RD	Tubular	ERG4007	-----	11821 (Set)	—	—	-----	21707M* (Set)	
	RD	Brazed & tubular	—	-----	11822 (Set)	—	—	-----	21708M* (Set)	
	RE	Tubular	ERG4007	-----	11822 (Set)	—	—	-----	21708M* (Set)	
	RE	Brazed	—	-----	11823 (Set)	—	—	-----	21709M* (Set)	
	RF	Tubular	—	-----	11823 (Set)	—	—	-----	21709M* (Set)	
	RF	Brazed	—	-----	11824 (Set)	—	—	-----	21710M* (Set)	
	RG	Tubular	—	-----	11824 (Set)	—	—	-----	21710M* (Set)	
	RH	Tubular	—	-----	11825 (Set)	—	—	-----	21711M* (Set)	
	RJ	Tubular	—	-----	11826 (Set)	—	—	-----	21712M* (Set)	
	RK	Tubular	—	-----	11827 (Set)	—	—	-----	21713M* (Set)	
RL	Tubular	—	-----	11828 (Set)	—	—	-----	21714M* (Set)		
RM	Tubular	—	-----	11829 (Set)	—	—	-----	21715M* (Set)		
Non-insulated flag terminals	D	—	WT129	—	—	—	—	—	21733	21731
	E	—	WT129	—	—	—	—	—	21734	21731
	F	—	WT129	—	—	—	—	—	21735	21731
	G	—	WT129	—	—	—	—	—	21736	21732
	H	—	—	—	—	—	—	—	21737	21732
	J	—	—	—	—	—	—	—	21738	21732
	K	—	—	—	—	—	—	—	21739	21732
	L	—	—	—	—	—	—	—	21740	21732
	M	—	—	—	—	—	—	—	21741	21732

* Indicates military listed die.

** To order the military version, suffix the indentor catalogue number with an "M" (13650M). Nest catalogue number does not change.

¹Tefzel is a registered trademark of DuPont.

Wire guide table

Stud size and clearance hole chart

Stud size	2	4	6	8	10	¼	⅜	½	⅝	¾	⅞	1
Min. hole dia. (in.)	0.92	0.116	0.143	0.169	0.196	0.262	0.323	0.388	0.453	0.516	0.650	0.775
Min. hole dia. (mm)	2.337	2.946	3.632	4.292	4.978	6.655	8.204	9.855	11.506	13.106	16.510	19.685

Wire strip length chart

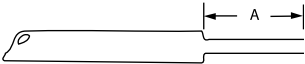
Diagram	Wire strip length	Terminal series	Recommend wire strip length "A" standard terminals (in.)
	Non-insulated	A	¼
		B	¼
		C, BC	5/16
	Vinyl insulated — Add 1/16 in. for funnel-entry type	RA	¼
		RB	¼
		RC, RBC	11/32
	Nylon-insulated and Tefzel insulated	RA	7/32
		RB	7/32
		RC, RBC	5/16
	Nylon-insulated and Tefzel insulated when using aircraft and code wire	RD	17/32
		RE	17/32
		RF	9/16
		RG	11/16
		RH	11/16
		RJ	¾
		RK	7/8
	Non-insulated, when using aircraft and code wire	RL	7/8
		RM	1
		D	15/32
		E	15/32
F		½	
G		41/64	
H		43/64	
J		47/64	
K	55/64		
L	55/64		
M	59/64		

Tefzel is a registered trademark of DuPont

Wire guide table

AWG or AN	Individual strands			Whole conductor		
	Navy shipboard†	No.	Dia. (in.)	Cir. mil. area	Dia. (in.)	Dia. (mm)
22 Wire size						
22	⅜ (1)	1	0.025	642	0.025	0.635
22	⅜ (7)	7	0.010	703	0.030	0.762
AN-22*		7	**	704	0.032	0.813
	½ (21)	21	0.005	525	0.028	0.711
20 Wire size						
20	1 (1)	1	0.032	1,022	0.032	0.813
20	–	7	0.012	1,024	0.036	0.914
20	–	10	0.010	1,005	0.040	1.016
20	–	19	0.007	1,022	0.037	0.940
20	–	26	0.006	1,034	0.039	0.991
AN-20*	–	7	**	1,119	0.040	1.016
–	1 (7)	7	0.013	1,119	0.038	0.965
–	1 (10)	10	0.010	1,005	0.038	0.965
–	1 (26)	26	0.006	1,034	0.042	1.067
18 Wire size						
18	1½ (1)	1	0.040	1,624	0.040	1.016
18	1½ (7)	7	0.016	1,624	0.049	1.245
18	1½ (16)	16	0.010	1,608	0.049	1.245
18	–	19	0.009	1,624	0.046	1.168
18	1½ (41)	41	0.006	1,630	0.049	1.245
AN-18*	2 (7)	7	0.016	1,779	0.048	1.219
16 Wire size						
16	2½ (1)	1	0.051	2,583	0.051	1.295
16	–	7	0.019	2,583	0.058	1.473
16	–	19	0.012	2,601	0.058	1.473
16	–	26	0.010	2,613	0.059	1.499
16	–	65	0.006	2,580	0.058	1.473
AN-16*	2½ (19)	19	0.011	2,407	0.061	1.549
	2½ (26)	26	0.010	2,613	0.061	1.549
14 Wire size						
14	–	1	0.064	4,107	0.064	1.626
14	–	7	0.024	4,107	0.073	1.854
14	–	19	0.015	4,107	0.074	1.880
14	–	37	0.011	4,107	0.074	1.880
14	–	14	0.009	4,157	0.083	2.108
14	–	104	0.006	4,128	0.074	1.880
AN-14*	–	19	**	3,830	0.076	1.930
–	3 (7)	7	0.020	2,828	0.060	1.524
–	3 (19)	19	0.013	3,036	0.063	1.600
–	4 (1)	1	0.064	4,107	0.064	1.626
–	4 (7)	7	0.025	4,497	0.076	1.930
–	4 (19)	19	0.014	3,828	0.072	1.829
–	4 (41)	41	0.010	4,121	0.077	1.956

AWG or AN	Individual strands			Whole conductor		
	Navy shipboard†	No.	Dia. (in.)	Cir. mil. area	Dia. (in.)	Dia. (mm)
12 Wire size						
12	–	1	0.081	6,530	0.081	2.057
12	–	7	0.031	6,530	0.092	2.337
12	–	19	0.019	6,530	0.093	2.362
12	–	37	0.013	6,530	0.093	2.362
12	–	49	0.012	6,593	0.104	2.642
12	–	65	0.010	6,533	0.093	2.362
12	–	104	0.008	6,574	0.094	2.388
12	–	165	0.006	6,559	0.095	2.413
AN-12*	6 (19)	19	0.018	6,088	0.096	2.438
–	6 (7)	7	0.031	6,512	0.092	2.337
–	6 (65)	65	0.010	6,533	0.097	2.964
10 Wire size						
10	–	1	0.102	10,380	0.102	2.591
10	–	7	0.039	10,380	0.116	2.946
10	–	19	0.023	10,380	0.117	2.972
10	–	37	0.017	10,443	0.117	2.972
10	–	49	0.015	10,445	0.131	2.327
10	–	104	0.010	10,452	0.116	2.946
AN-10*	–	37	**	10,380	0.117	2.972
–	9 (7)	7	0.036	9,016	0.108	2.743
–	9 (37)	37	0.016	9,402	0.109	2.769
–	9 (90)	90	0.010	9,045	0.120	3.048

* MIL-W-5086. ** Strand diameter not specified. † MIL-E-16366 A.

Wire guide table

AWG or AN	Individual strands		Whole conductor			
	Navy shipboard†	No.	Dia. (in.)	Cir. mil. area	Dia. (in.)	Dia. (mm)
9 Wire size						
9	–	7	0.043	13,090	0.130	3.302
	14 (7)	7	0.045	14,340	0.136	3.454
8 Wire size						
8	–	7	0.049	16,510	0.146	3.712
8	–	19	0.030	16,510	0.148	3.763
8	–	37	0.021	16,510	0.148	3.763
7 Wire size						
7	–	1	0.144	20,820	0.144	3.662
–	14 (7)	7	0.045	14,340	0.136	3.454
–	14 (140)	140	0.010	14,070	0.145	3.787
6 Wire size						
6	–	7	0.061	25,250	0.184	4.672
6	–	19	0.037	26,250	0.186	4.722
6	–	37	0.027	26,250	0.186	4.722
6	–	49	0.023	26,146	0.208	5.283
6	–	661	0.006	26,274	0.259	6.579
5 Wire size						
5	–	1	0.181	33,100	0.181	4.595
–	20 (49)	7x7	0.020	19,800	0.180	4.570
–	23 (7)	7	0.057	22,800	0.171	4.345
–	23 (228)	19x12	0.010	22,190	0.190	4.830
–	26 (49)	7x7	0.023	26,250	0.210	5.330
4 Wire size						
4	–	7	0.077	41,740	0.232	5.891
4	–	19	0.047	41,740	0.235	5.967
4	–	37	0.034	41,740	0.235	5.967
3 Wire size						
3	–	1	0.229	52,630	0.229	5.819
–	30 (304)	19x16	0.010	30,550	0.220	5.590
–	33 (336)	7x48	0.010	33,370	0.235	5.967
–	40 (19)	19	0.045	38,910	0.226	5.742
–	42 (49)	7x7	0.029	41,740	0.260	6.600
–	42 (209)	19x11	0.014	42,110	0.260	6.600
–	50 (19)	19	0.051	49,080	0.254	6.452

AWG or AN	Individual strands		Whole conductor			
	Navy shipboard†	No.	Dia. (in.)	Cir. mil. area	Dia. (in.)	Dia. (mm)
2 Wire size						
2	–	7	0.097	66,370	0.292	7.421
2	–	19	0.059	66,370	0.296	7.522
2	–	37	0.042	66,370	0.297	7.548
2	–	49	0.037	66,356	0.331	8.405
2	–	133	0.022	66,140	0.335	8.507
AN-2*	–	663	**	66,832	0.345	8.767
–	53 (532)	19x28	0.010	53,470	0.304	7.772
–	60 (37)	37	0.040	60,090	0.282	7.161
–	60 (304)	19x16	0.014	61,260	0.310	7.870
–	66 (133)	19x7	0.022	66,370	0.330	8.380
–	75 (37)	37	0.045	75,780	0.317	8.048
1 Wire size						
1	–	7	0.109	83,690	0.328	8.333
1	–	19	0.066	83,690	0.332	8.431
1	–	37	0.048	83,690	0.333	8.456
1	–	61	0.037	83,690	0.333	8.456
1	–	133	0.025	83,690	0.377	9.578
1	–	259	0.018	83,916	0.378	9.603
AN-1*	–	812	**	81,807	0.384	9.752
–	83 (418)	19x22	0.014	84,230	0.380	9.650
–	84 (2,107)	2107	**	83,690	0.410	10.41

* MIL-W-5086.

** Strand diameter not specified.

† MIL-E-16366 A

Wire guide table

AWG or AN	Navy shipboard†	Individual strands		Whole conductor		
		No.	Dia. (in.)	Cir. Mil. Area	Dia. (in.)	Dia. (mm)
1/0 Wire size						
1/0	–	7	0.123	105,500	0.368	9.343
1/0	–	19	0.075	105,500	0.373	9.476
1/0	–	37	0.053	105,500	0.374	9.502
1/0	–	61	0.042	105,500	0.374	9.502
1/0	–	133	0.028	105,761	0.423	10.721
1/0	–	259	0.020	105,672	0.424	10.772
AN-0*	–	1,033	**	104,118	0.432	10.971
–	100 (61)	61	0.040	99,060	0.363	9.216
–	105 (259)	37x7	**	105,500	0.410	10.410
2/0 Wire Size						
–	105 (2,646)	2,646	**	105,500	0.460	11.680
2/0	–	7	0.138	133,100	0.414	10.512
2/0	–	19	0.084	133,100	0.419	10.639
2/0	–	37	0.060	133,100	0.420	10.670
2/0	–	61	0.047	133,100	0.420	10.670
2/0	–	133	0.032	132,800	0.474	12.042
2/0	–	259	0.023	133,462	0.477	12.118
AN-00*	–	1,327	**	133,665	0.490	12.450
–	125 (61)	61	0.045	124,900	0.407	10.338
–	133 (259)	37x7	**	133,100	0.460	11.680
–	133 (684)	19x36	0.014	137,800	0.480	12.190
–	133 (3,325)	3,325	**	133,100	0.520	13.210
–	150 (61)	61	0.051	157,600	0.457	11.608
3/0 Wire size						
3/0	–	7	0.155	167,800	0.464	11.782
3/0	–	19	0.094	167,800	0.470	11.940
3/0	–	37	0.067	167,800	0.471	11.965
3/0	–	61	0.052	167,800	0.472	11.991
3/0	–	133	0.036	167,607	0.533	13.536
3/0	–	259	0.026	167,402	0.536	13.612
3/0	–	4,227	0.006	168,023	0.610	15.490
–	150 (760)	19x40	0.014	153,100	0.510	12.950
–	168 (427)	61x7	**	167,800	0.520	13.210

AWG or AN	Navy shipboard†	Individual strands		Whole conductor		
		No.	Dia. (in.)	Cir. Mil. Area	Dia. (in.)	Dia. (mm)
4/0 Wire size						
4/0	–	7	0.174	211,600	0.522	13.261
4/0	–	19	0.106	211,600	0.528	13.413
4/0	–	37	0.076	211,600	0.529	13.439
4/0	–	61	0.059	211,600	0.530	13.460
4/0	–	133	0.040	211,736	0.599	15.219
4/0	–	259	0.029	211,845	0.601	15.265
AN-000*	–	1,661	**	167,332	0.548	13.923
–	200 (61)	61	0.057	198,700	0.514	13.652
–	200 (988)	19x52	0.014	199,100	0.580	14.730
250 kcmil Wire size						
250,000	–	19	0.115	250,000	0.574	14.582
250,000	–	37	2	250,000	0.575	14.607
250,000	–	61	0.064	250,000	0.576	14.632
250,000	–	91	0.052	250,000	0.576	14.632
AN-0000*	–	2,104	**	211,954	0.615	15.617
–	220 (259)	37x7	0.029	220,700	0.610	15.490
–	250 (61)	61	0.064	250,000	0.577	14.658

* MIL-W-5086.

** Strand diameter not specified.

†MIL-E-16366 A

Packaging cross reference

Cat. no. ABB distributor package	Cat. no. ABB bulk package	Cat. no. ABB distributor package	Cat. no. ABB bulk package	Cat. no. ABB distributor package	Cat. no. ABB bulk package	Cat. no. ABB distributor package	Cat. no. ABB bulk package
10RC-10	RC367	14RB-8	RB867	2B-16	RBB25	B14-10G	B87G
10RC-10F	RC1157	14RB-8F	RB657	2B18-16	B1B	B14-110F	B10TB
10RC-10FL	RC2227	14RB-8FL	RB2237	2C-10	CC2-TB	B14-111F	B11-TB
10RC-10FLX	RC2227-250	14RB-8FLX	RB2237-200	2C-12	RCC26	B14-12	B75TB
10RC-10FX	RC1157-250	14RB-8FX	RB657-200	2C14-12	C1C	B14-14	B71
10RC-10X	RC367-250	14RB-8X	RB867-200	2D10-9	D1D	B14-250	B250
10RC-14	RC717	14RBC-10	RBC877	2D-8	DD102	B14-250A	B252G
10RC-14F	RC1167	14RBC-12	RBC757	2E-6	EE2	B14-250F	B250G
10RC-14FL	RC2237	14RBC-14	RBC717	2E8-7	E1E	B14-250T	B251G
10RC-14X	RC717-250	14RBC-38	RBC797	2F-4	FF2	B14-251T	B251
10RC-250F	RC257	14RBC-516	RBC727	2F6-5	F1F	B14-38	B73
10RC-250T	RC2517	14RBC-6	RBC857	2G21	GG2	B14-4	B132
10RC-251T	RC25177	14RBC-8	RBC867	2G4-2	G1G	B14-516	B72
10RC-2577	RC2573	14RBD-182	RBD1827	2RA18	RAA21	B14-6	B133
10RC-38	RC737	14RBD-18277	RBD18277	2RA18X	RAA217-170	B14-6F	B64
10RC-38X	RC737-250	14RBD-183	RBD1837	2RAA	RAA23	B14-6FL	B220-TB
10RC-516	RC707	14RBD-18377	RBD18377	2RB14	RBB21	B14-6FS	B19
10RC-55PT	RC55PT	18RA-10	RA877	2RB14X	RBB217-200	B14-8	B86
10RC-6	RC337	18RA-10F	RA1157	2RBB	RBB23	B14-8F	B65TB
10RC-6F	RC1337	18RA-10FL	RA2257	2RC10	RCC21	B14-8FL	B223
10RC-6FL	RC2207	18RA-10FLX	RA2257-170	2RC10X	RCC217-250	B14-D	B23
10RC-6FLX	RC2207-250	18RA-14	RA717	2RCC	RCC23	BC14-10	BC87
10RC-6X	RC337-250	18RA-250F	RA257	2RD8	RDD27	BC14-12	BC75
10RC-8	RC777	18RA-250T	RA2517	2RE6	REE28	BC14-14	BC71
10RC-8F	RC1147	18RA-251T	RA25177	A18-10	A87	BC14-38	BC79
10RC-8FL	RC2217	18RA-2577	RA2573	A18-10F	A115-TB	BC14-516	BC72
10RC-8FLX	RC2217-250	18RA-38	RA737	A18-10FL	A225	BC14-6	BC85
10RC-8X	RC777-250	18RA-4	RA77	A18-110F	A10-TB	BC14-8	BC86
14RB-10	RB877	18RA-47PT	RA47PT	A18-111F	A11	BD14-183	BD183
14RB-10F	RB1157	18RA-516	RA727	A18-12	A75	C10-10	C26
14RB-10FL	RB2257	18RA-516X	RA727-170	A18-14	A71	C10-10A	C53-TB
14RB-10FLX	RB2257-200	18RA-6	RA857	A18-250	A250-TB	C10-10F	C115
14RB-10FX	RB1157-200	18RA-6F	RA1167	A18-250A	A252G	C10-10FL	C222-TB
14RB-10X	RB877-200	18RA-6FL	RA2217	A18-251T	A251	C10-12	C75
14RB-14	RB717	18RA-6FLX	RA2217-170	A18-38	A73	C10-14	C71
14RB-14X	RB717-200	18RA-6FX	RA1167-170	A18-516	A72	C10-14F	C116-TB
14RB-250F	RB257	18RA-6X	RA857-170	A18-6	A85	C10-250A	C252G
14RB-250T	RB2517	18RA-8	RA867	A18-6F	A116	C10-250F	C250
14RB-251T	RB25177	18RA-8F	RA1147	A18-6FL	A221	C10-38	C73
14RB-2577	RB2573	18RA-8FL	RA2247	A18-8	A86	C10-516	C70
14RB-38	RB737	18RA-8FX	RA1147-170	A18-8F	A114	C10-6A	C51
14RB-4	RB1327	18RA-8X	RA867-170	A18-8FL	A224	C10-6F	C133
14RB-47PT	RB47PT	18RAD-182	RAD1827	AB14-10A	AB53	C10-6FL	C220-TB
14RB-516	RB727	18RAD-18277	RAD18277	AB14-6A	AB51	C10-6-SK	C33-TB
14RB-6	RB857	18RAD-183	RAD1837	AB14-8A	AB52	C10-8A	C52-TB
14RB-6F	RB647	18RAD-18377	RAD18377	AD18-182	AD182	C10-8F	C114
14RB-6FL	RB2207	2A-18	AA2	AD18-183	AD183	C10-8FL	C221
14RB-6FLX	RB2207-200	2A20	RAA24	B14-10	B87	C10-8-SK	C77
14RB-6FX	RB647-200	2A22-20	A1A	B14-10F	B115	D8-10	D36
14RB-6X	RB857-200	2B-14	BB2	B14-10FL	B225	D8-12	D75

Packaging cross reference

Cat. no. ABB distributor package	Cat. no. ABB bulk package	Cat. no. ABB distributor package	Cat. no. ABB bulk package	Cat. no. ABB distributor package	Cat. no. ABB bulk package	Cat. no. ABB distributor package	Cat. no. ABB bulk package
D8-14-SK	D71	RA18-8FS	RA1223	RC10-250A	RC2577F	A73	A18-38
D8-38	D73	RA18D	RA23	RC10-250F	RC250	A75	A18-12
D8-516	D72	RAD18-182	RAD1823	RC10-38	RC733	A85	A18-6
E6-10	E26	RAD18-183	RAD1833	RC10-38X	RC734	A86	A18-8
E6-12	E75	RB14-10	RB873	RC10-516	RC703	A87	A18-10
E6-14	E71	RB14-10F	RB1153	RC10-55PT	RC155PT	AA2	2A-18
E6-38	E73	RB14-10FL	RB2253	RC10-6	RC333	AB51	AB14-6A
E6-516	E72	RB14-10FS	RB1253	RC10-6F	RC1113	AB52	AB14-8A
F250TA	FTA250	RB14-10X	RB874	RC10-6FL	RC2203	AB53	AB14-10A
F4-10	F26	RB14-110F	RB10-SK	RC10-8	RC863	AD182	AD18-182
F4-12	F75	RB14-111F	RB11-TB	RC10-8F	RC1123	AD183	AD18-183
F4-14	F71-TB	RB14-12	RB753	RC10-8FL	RC2213	B10TB	B14-110F
F4-38	F73	RB14-14	RB713	RC10-8FS	RC1223	B115	B14-10F
F4-516	F72	RB14-14F	RB1163	RC10-8X	RC864	B11-TB	B14-111F
G2-12	G975	RB14-14X	RB714	RC55	RC6	B132	B14-4
G2-14	G971	RB14-250	RBB250	RD8-10	RD367	B133	B14-6
G2-38	G973	RB14-250A	RB2577F	RD8-12	RD757	B19	B14-6FS
G2-516	G972	RB14-250F	RB250	RD8-14	RD717	B1B 2	B18-16
H10-14	H971	RB14-250FP	RB250P	RD8-38	RD737	B220-TB	B14-6FL
J20-38	J973	RB14-38	RB733	RD8-516	RD727	B223	B14-8FL
K30-38	K973	RB14-38X	RB734	RE6-10	RE267	B225	B14-10FL
L40-38	L973	RB14-4	RB1323	RE6-12	RE757	B23	B14-D
M250-38	M973	RB14-47PT	RB147PT	RE6-14	RE717	B250	B14-250
NW14-10	NW83	RB14-516	RB723	RE6-38	RE737	B250G	B14-250F
NW14-12	NW84	RB14-516X	RB724	RE6-516	RE727	B251	B14-251T
NW14-6	NW81	RB14-6	RB853	RF4-10	RF267	B251G	B14-250T
NW22-10	NW23	RB14-6F	RB1113	RF4-12	RF757	B252G	B14-250A
RA18-10	RA873	RB14-6FL	RB2213	RF4-14	RF717	B64	B14-6F
RA18-10F	RA1153	RB14-6FS	RB1203	RF4-38	RF737	B65TB	B14-8F
RA18-10FL	RA2253	RB14-6X	RB854	RF4-516	RF727	B71	B14-14
RA18-10FS	RA1253	RB14-8	RB863	RG2-10	RG267	B72	B14-516
RA18-110F	RA10SK	RB14-8F	RB1123	RG2-12	RG757	B73	B14-38
RA18-111F	RA11	RB14-8FL	RB2233	RG2-14	RG717	B75TB	B14-12
RA18-12	RA753	RB14-8FS	RB1223	RG2-38	RG737	B86	B14-8
RA18-14	RA713	RB14-8X	RB864	RG2-516	RG727	B87	B14-10
RA18-14F	RA1163	RB44	RB4-TB	RP12	RP7	B87G	B14-10G
RA18-250A	RA2577F	RBC14-14	RBC713	A10-TB	A18-110F	BB2	2B-14
RA18-250F	RA250TB	RBC14-516	RBC723	A11	A18-111F	BC71	BC14-14
RA18-250FP	RA250P	RBD14-182	RBD1823	A114	A18-8F	BC72	BC14-516
RA18-38	RA733	RBD14-183	RBD1833	A115-TB	A18-10F	BC75	BC14-12
RA18-4	RA323	RC10-10	RC363	A116	A18-6F	BC79	BC14-38
RA18-47PT	RA147PT	RC10-10F	RC1153	A1A 2	A22-20	BC85	BC14-6
RA18-516	RA723	RC10-10FL	RC2223	A221	A18-6FL	BC86	BC14-8
RA18-6	RA853	RC10-10FS	RC1253	A224	A18-8FL	BC87	BC14-10
RA18-6F	RA1103	RC10-10X	RC364	A225	A18-10FL	BD183	BD14-183
RA18-6FL	RA2213	RC10-12	RC753	A250-TB	A18-250	C114	C10-8F
RA18-6FS	RA1203	RC10-14	RC713	A251	A18-251T	C115	C10-10F
RA18-8	RA863	RC10-14F	RC1163	A252G	A18-250A	C116-TB	C10-14F
RA18-8F	RA1123	RC10-14FL	RC2233	A71	A18-14	C133	C10-6F
RA18-8FL	RA2243	RC10-14X	RC714	A72	A18-516	C1C 2	C14-12

Packaging cross reference

Cat. no. ABB distributor package	Cat. no. ABB bulk package	Cat. no. ABB distributor package	Cat. no. ABB bulk package	Cat. no. ABB distributor package	Cat. no. ABB bulk package	Cat. no. ABB distributor package	Cat. no. ABB bulk package
C220-TB	C10-6FL	NW81	NW14-6	RA867-170	18RA-8X	RB714	RB14-14X
C221	C10-8FL	NW83	NW14-10	RA873	RA18-10	RB717	14RB-14
C222-TB	C10-10FL	NW84	NW14-12	RA877	18RA-10	RB717-200	14RB-14X
C250	C10-250F	RA10SK	RA18-110F	RAA21	2RA18	RB723	RB14-516
C252G	C10-250A	RA11	RA18-111F	RAA217-170	2RA18X	RB724	RB14-516X
C26	C10-10	RA1103	RA18-6F	RAA23	2RAA	RB727	14RB-516
C33-TB	C10-6-SK	RA1123	RA18-8F	RAA24	2A20	RB733	RB14-38
C51	C10-6A	RA1147	18RA-8F	RAD1823	RAD18-182	RB734	RB14-38X
C52-TB	C10-8A	RA1147-170	18RA-8FX	RAD1827	18RAD-182	RB737	14RB-38
C53-TB	C10-10A	RA1153	RA18-10F	RAD18277	18RAD-18277	RB753	RB14-12
C70	C10-516	RA1157	18RA-10F	RAD1833	RAD18-183	RB853	RB14-6
C71	C10-14	RA1163	RA18-14F	RAD1837	18RAD-183	RB854	RB14-6X
C73	C10-38	RA1167	18RA-6F	RAD18377	18RAD-18377	RB857	14RB-6
C75	C10-12	RA1167-170	18RA-6FX	RB10-SK	RB14-110F	RB857-200	14RB-6X
C77	C10-8-SK	RA1203	RA18-6FS	RB1113	RB14-6F	RB863	RB14-8
CC2-TB	2C-10	RA1223	RA18-8FS	RB1123	RB14-8F	RB864	RB14-8X
D1D	2D10-9	RA1253	RA18-10FS	RB1153	RB14-10F	RB867	14RB-8
D36	D8-10	RA147PT	RA18-47PT	RB1157	14RB-10F	RB867-200	14RB-8X
D71	D8-14-SK	RA2213	RA18-6FL	RB1157-200	14RB-10FX	RB873	RB14-10
D72	D8-516	RA2217	18RA-6FL	RB1163	RB14-14F	RB874	RB14-10X
D73	D8-38	RA2217-170	18RA-6FLX	RB11-TB	RB14-111F	RB877	14RB-10
D75	D8-12	RA2243	RA18-8FL	RB1203	RB14-6FS	RB877-200	14RB-10X
DD102	2D-8	RA2247	18RA-8FL	RB1223	RB14-8FS	RBB21	2RB14
E1E	2E8-7	RA2253	RA18-10FL	RB1253	RB14-10FS	RBB217-200	2RB14X
E26	E6-10	RA2257	18RA-10FL	RB1323	RB14-4	RBB23	2RBB
E71	E6-14	RA2257-170	18RA-10FLX	RB1327	14RB-4	RBB25	2B-16
E72	E6-516	RA23	RA18D	RB147PT	RB14-47PT	RBB250	RB14-250
E73	E6-38	RA250P	RA18-250FP	RB2207	14RB-6FL	RBC713	RBC14-14
E75	E6-12	RA250TB	RA18-250F	RB2207-200	14RB-6FLX	RBC717	14RBC-14
EE2	2E-6	RA2517	18RA-250T	RB2213	RB14-6FL	RBC723	RBC14-516
F1F	2F6-5	RA25177	18RA-251T	RB2233	RB14-8FL	RBC727	14RBC-516
F26	F4-10	RA257	18RA-250F	RB2237	14RB-8FL	RBC757	14RBC-12
F71-TB	F4-14	RA2573	18RA-2577	RB2237-200	14RB-8FLX	RBC797	14RBC-38
F72	F4-516	RA2577F	RA18-250A	RB2253	RB14-10FL	RBC857	14RBC-6
F73	F4-38	RA323	RA18-4	RB2257	14RB-10FL	RBC867	14RBC-8
F75	F4-12	RA47PT	18RA-47PT	RB2257-200	14RB-10FLX	RBC877	14RBC-10
FF2	2F-4	RA713	RA18-14	RB250	RB14-250F	RBD1823	RBD14-182
FTA250	F250TA	RA717	18RA-14	RB250P	RB14-250FP	RBD1827	14RBD-182
G1G	2G4-2	RA723	RA18-516	RB2517	14RB-250T	RBD18277	14RBD-18277
G971	G2-14	RA727	18RA-516	RB25177	14RB-251T	RBD1833	RBD14-183
G972	G2-516	RA727-170	18RA-516X	RB257	14RB-250F	RBD1837	14RBD-183
G973	G2-38	RA733	RA18-38	RB2573	14RB-2577	RBD18377	14RBD-18377
G975	G2-12	RA737	18RA-38	RB2577F	RB14-250A	RC1113	RC10-6F
GG2	2G21	RA753	RA18-12	RB47PT	14RB-47PT	RC1123	RC10-8F
H971	H10-14	RA77	18RA-4	RB4-TB	RB44	RC1147	10RC-8F
J973	J20-38	RA853	RA18-6	RB647	14RB-6F	RC1153	RC10-10F
K973	K30-38	RA857	18RA-6	RB647-200	14RB-6FX	RC1157	10RC-10F
L973	L40-38	RA857-170	18RA-6X	RB657	14RB-8F	RC1157-250	10RC-10FX
M973	M250-38	RA863	RA18-8	RB657-200	14RB-8FX	RC1163	RC10-14F
NW23	NW22-10	RA867	18RA-8	RB713	RB14-14	RC1167	10RC-14F

Packaging cross reference

Cat. no. ABB distributor package	Cat. no. ABB bulk package	Cat. no. ABB distributor package	Cat. no. ABB bulk package
RC1223	RC10-8FS	RD717	RD8-14
RC1253	RC10-10FS	RD727	RD8-516
RC1337	10RC-6F	RD737	RD8-38
RC155PT	RC10-55PT	RD757	RD8-12
RC2203	RC10-6FL	RDD27	2RD8
RC2207	10RC-6FL	RE267	RE6-10
RC2207-250	10RC-6FLX	RE717	RE6-14
RC2213	RC10-8FL	RE727	RE6-516
RC2217	10RC-8FL	RE737	RE6-38
RC2217-250	10RC-8FLX	RE757	RE6-12
RC2223	RC10-10FL	REE28	2RE6
RC2227	10RC-10FL	RF267	RF4-10
RC2227-250	10RC-10FLX	RF717	RF4-14
RC2233	RC10-14FL	RF727	RF4-516
RC2237	10RC-14FL	RF737	RF4-38
RC250	RC10-250F	RF757	RF4-12
RC2517	10RC-250T	RG267	RG2-10
RC25177	10RC-251T	RG717	RG2-14
RC257	10RC-250F	RG727	RG2-516
RC2573	10RC-2577	RG737	RG2-38
RC2577F	RC10-250A	RG757	RG2-12
RC333	RC10-6	RP7	RP12
RC337	10RC-6		
RC337-250	10RC-6X		
RC363	RC10-10		
RC364	RC10-10X		
RC367	10RC-10		
RC367-250	10RC-10X		
RC55PT	10RC-55PT		
RC6	RC55		
RC703	RC10-516		
RC707	10RC-516		
RC713	RC10-14		
RC714	RC10-14X		
RC717	10RC-14		
RC717-250	10RC-14X		
RC733	RC10-38		
RC734	RC10-38X		
RC737	10RC-38		
RC737-250	10RC-38X		
RC753	RC10-12		
RC777	10RC-8		
RC777-250	10RC-8X		
RC863	RC10-8		
RC864	RC10-8X		
RCC21	2RC10		
RCC217-250	2RC10X		
RCC23	2RCC		
RCC26	2C-12		
RD367	RD8-10		

Catamount terminals



Catamount terminals – now in convenient, spillproof, re-usable packaging.

While poly bags keep their contents dry, they don't offer much other protection, and they aren't environmentally friendly. That's why Catamount terminals now come in sturdy plastic containers that safeguard the connectors inside against crushing and can be re-used or recycled when empty. ABB is always adding value to its products. With the introduction of a durable plastic container, the value of ABB's Catamount terminals has been significantly enhanced. No more lost or spilled terminals because of inadequate packaging.



Vinyl-insulated ring terminals



Cat. no.	Wire range (AWG)	Bolt hole (in.)	Pkg. qty.
TV18-6R-XV	22-16	#6	15
TV18-8R-XV	22-16	#8	15
TV18-10R-XV	22-16	#10	15
TV14-6R-XV	16-14	#6	15
TV14-8R-XV	16-14	#8	15
TV14-10R-XV	16-14	#10	15
TV10-8R-XV	12-10	#8	15
TV10-10R-XV	12-10	#10	15
TV10-14R-XV	12-10	¼	15



Vinyl-insulated fork terminals



Cat. no.	Wire range (AWG)	Bolt hole (in.)	Pkg. qty.
TV18-6F-XV	22-16	#6	15
TV18-8F-XV	22-16	#8	15
TV14-6F-XV	16-14	#6	15
TV14-8F-XV	16-14	#8	15
TV14-10F-XV	16-14	#10	15
TV10-8F-XV	12-10	#8	15
TV10-10F-XV	12-10	#10	15
TV10-14F-XV	12-10	¼	15



Vinyl-insulated butt splices



Cat. no.	Wire range (AWG)	Pkg. qty.
TV18-BS-XV	22-16	15
TV14-BS-XV	16-14	15
TV10-BS-XV	12-10	15

Vinyl-insulated butt splices kit



Cat. no.	Wire range (AWG)	Qty	Pkg. qty.
TV10-18-BS	22-18	5	15
	16-14	5	15
	12-10	5	15



Nylon-insulated wire joints



Cat. no.	Wire range (AWG)	Pkg. qty.
TN18-WJ-XV	22-18	15
TN14-WJ-XV	16-14	15
TN10-WJ-XV	12-10	15



Vinyl-insulated female disconnects – 250 series



Cat. no.	Wire range (AWG)	Pkg. qty.
TV18-250FD-XV	22-16	15
TV14-250FD-XV	16-14	15
TV10-250FD-XV	12-10	15



Vinyl-insulated male disconnects – 250 series



Cat. no.	Wire range (AWG)	Pkg. qty.
TV18-250MD-XV	22-16	15
TV14-250MD-XV	16-14	15
TV10-250MD-XV	12-10	15



Vinyl-insulated pin terminal



Cat. no.	Wire range (AWG)	Pkg. qty.
TV18-12PT-XV	22-16	15
TV14-12PT-XV	16-14	15
TV10-14PT-XV	12-10	15



Vinyl-insulated blade terminal



Cat. no.	Wire range (AWG)	Pkg. qty.
TV18-10BL-XV	22-16	15
TV14-10BL-XV	16-14	15
TV14-18BL-XV	16-14	15
TV10-10BL-XV	12-10	15

Catamount terminals



Vinyl-insulated double crimp locking fork 

Cat. no.	Wire range (AWG)	Pkg. qty.
TV18-10LFD-XV	22-16	15
TV18-6LFD-XV	22-16	15
TV18-8LFD-XV	22-16	15
TV14-10LFD-XV	16-14	15
TV14-6LFD-XV	16-14	15
TV14-8LFD-XV	16-14	15
TV10-10LFD-XV	12-10	15
TV10-6LFD-XV	12-10	15
TV10-8LFD-XV	12-10	15



Vinyl-insulated locking fork terminal 

Cat. no.	Wire range (AWG)	Pkg. qty.
TV18-10LF-XV	22-16	15
TV18-6LF-XV	22-16	15
TV18-8LF-XV	22-16	15
TV14-10LF-XV	16-14	15
TV14-6LF-XV	16-14	15
TV14-8LF-XV	16-14	15
TV10-10LF-XV	12-10	15
TV10-6LF-XV	12-10	15
TV10-8LF-XV	12-10	15



Non-insulated ring terminals 

Cat. no.	Wire range (AWG)	Pkg. qty.
T14-10R-XV	16-14	15
T14-8R-XV	16-14	15
T10-10R-XV	12-10	15
T10-14R-XV	12-10	15
T10-8R-XV	12-10	15



Non-insulated fork terminals 

Cat. no.	Wire range (AWG)	Pkg. qty.
T18-10F-XV	22-18	15
T18-8F-XV	22-18	15
T14-10F-XV	16-14	15
T14-8F-XV	16-14	15
T10-10F-XV	12-10	15
T10-14F-XV	12-10	15
T10-8F-XV	12-10	15



Vinyl fully insulated double crimp female disconnect 

Cat. no.	Wire range (AWG)	Pkg. qty.
TVF18-250FDD-XV	22-16	15
TVF14-250FDD-XV	16-14	15
TVF10-250FDD-XV	12-10	15



Vinyl fully insulated female disconnect 

Cat. no.	Wire range (AWG)	Pkg. qty.
TVF18-250FD-XV	22-16	15
TVF14-250FD-XV	16-14	15
TVF10-250FD-XV	12-10	15



Vinyl-insulated double crimp piggy-back disconnect 

Cat. no.	Wire range (AWG)	Pkg. qty.
TV18-250PDD-XV	22-16	15
TV14-250PDD-XV	16-14	15
TV10-250PDD-XV	12-10	15



Vinyl-insulated piggy-back disconnect 

Cat. no.	Wire Range (AWG)	Pkg. qty.
TV18-250PD-XV	22-16	15
TV14-250PD-XV	16-14	15
TV10-250PD-XV	12-10	15



Vinyl-insulated quick splice 

Cat. no.	Wire range (AWG)	Pkg. qty.
TV18-00QS-V	22-18	15
TV14-00QS-V	18-14	15
TV10-00QS-V	12-10	15



Vinyl-insulated double crimp female disconnect 

Cat. no.	Wire range (AWG)	Pkg. qty.
TV18-250FDD-XV	22-16	15
TV14-250FDD-XV	16-14	15
TV10-250FDD-XV	12-10	15

Catamount terminals



Nylon fully insulated female disconnect



Cat. no.	Wire range (AWG)	Pkg. qty.
TNF18-250FD-XV	22-16	15
TNF14-250FD-XV	16-14	15
TNF10-250FD-XV	12-10	15



Nylon fully insulated male disconnect



Cat. no.	Wire range (AWG)	Pkg. qty.
TNF-18-250MD-XV	22-16	15
TNF-14-250MD-XV	16-14	15
TNF-10-250MD-XV	12-10	15



Nylon fully insulated female bullet



Cat. no.	Wire range (AWG)	Pkg. qty.
TNF18-4FB-XV	22-16	15
TNF14-4FB-XV	16-14	15



Nylon fully insulated male bullet



Cat. no.	Wire range (AWG)	Pkg. qty.
TNF18-4MB-XV	22-16	15
TNF14-4MB-XV	16-14	15



Nylon fully insulated double crimp female disconnects



Cat. no.	Wire range (AWG)	Pkg. qty.
TNF-18-250FDD-XV	22-16	15
TNF-14-250FDD-XV	16-14	15
TNF-10-250FDD-XV	12-10	15



Nylon fully insulated double crimp male disconnect



Cat. no.	Wire range (AWG)	Pkg. qty.
TNF-18-250MDD-XV	22-16	15
TNF-14-250MDD-XV	16-14	15
TNF-10-250MDD-XV	12-10	15



Vinyl-insulated double crimp male disconnect



Cat. no.	Wire range (AWG)	Pkg. qty.
TV-18-250MDD-XV	22-16	15
TV-14-250MDD-XV	16-14	15
TV-10-250MDD-XV	12-10	15

Catamount terminal tools

- 01 WT111M
- 02 WT112M
- 03 ERG1-WS
- 04 CM2000A
- 05 TBM6S



— 01



— 04



— 02



— 05



— 03

Cat. no.	Description	Pkg. qty.
WT111M	Plier tool with cutter for 22-10 AWG non-insulated terminals	1
WT112M	Pier tool with cutter for 22-10 AWG insulated and non-insulated terminals, splices and disconnects	1
TBM6S	Toggle-type hand tool with Shure-Stake for 8-6 AWG, vinyl-insulated terminals (dies sold separately)	1
ERG1-WS	Ergonomic wire stripping tool	1
CM2000A	10 in. ratchet crimping tool for insulated terminals (22-10 AWG)	1

Polycarbonate-insulated ring terminals



Technical information

Material	Electrolytic copper
Plating	Tin-plated
Marking	Wire size and bolt size stamped on the tongue
Metal barrel	Brazed seam to prevent barrel separation
Insulation	PC = Polycarbonate
Temperature resistance	115 °C / 125 °C
Colour coding of the insulation	According to the wire size
Cable insertion	Easy entry

Cat. no.	Wire size range (mm ²)	Colour	Stud hole size d2	Dimensions (mm)				Wt. (g/100)	Qty. (pieces)	Crimping tool
				W	L	D	L1			
RZ3	0.25–0.75	Green	M3	5.5	18.0	3.2	15.0	36	100	ERG2510
RZ4	0.25–0.75		M4	7.5	21.0	3.2	17.5	45	100	ERG2510
RZ5	0.25–0.75		M5	9.0	22.0	3.2	17.5	51	100	ERG2510
RA3RR	0.5–1.5	Red	M3	5.5	19.0	4.0	16.0	60	100	ERG2001A, WT2124Y
RA4RR	0.5–1.5		M4	7.0	20.5	4.0	17.0	71	100	ERG2001A, WT2124Y
RA5RR	0.5–1.5		M5	9.0	22.5	4.0	18.0	79	100	ERG2001A, WT2124Y
RA6RR	0.5–1.5		M6	11.0	26.5	4.0	21.0	96	100	ERG2001A, WT2124Y
RB3	1.5–2.5	Blue	M3	5.5	19.0	4.5	16.0	75	100	ERG2001A, WT2124Y
RB4-EU	1.5–2.5		M4	7.0	20.5	4.5	17.0	92	100	ERG2001A, WT2124Y
RB5	1.5–2.5		M5	9.0	22.5	4.5	18.0	96	100	ERG2001A, WT2124Y
RB6	1.5–2.5		M6	11.0	26.5	4.5	21.0	117	100	ERG2001A, WT2124Y
RB8	1.5–2.5		M8	14.0	27.5	4.5	21.0	141	100	ERG2001A, WT2124Y
RC4	4.0–6.0	Yellow	M4	8.0	24.0	6.4	20.5	158	100	ERG2001A, WT2124Y
RC5	4.0–6.0		M5	9.0	25.0	6.4	20.5	166	100	ERG2001A, WT2124Y
RC6-EU	4.0–6.0		M6	11.0	28.5	6.4	23.0	179	100	ERG2001A, WT2124Y
RC8	4.0–6.0		M8	14.0	31.0	6.4	24.0	220	100	ERG2001A, WT2124Y
RC10E	4.0–6.0		M10	17.0	34.0	6.4	25.5	245	100	ERG2001A, WT2124Y

Diagram

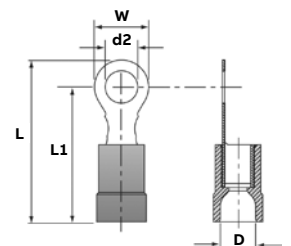

Polycarbonate-insulated fork terminals



Technical information

Material	Electrolytic copper
Plating	Tin-plated
Marking	Wire size and bolt size stamped on the tongue
Metal barrel	Brazed seam to prevent barrel separation
Insulation	PC = Polycarbonate
Temperature resistance	115 °C / 125 °C
Colour coding of the insulation	According to the wire size
Cable insertion	Easy entry

Cat. no.	Wire size range (mm ²)	Colour	Stud hole size d2	Dimensions (mm)				Wt. (g/100)	Qty. (pieces)	Crimping tool
				W	L	D	L1			
RZ3F	0.25–0.75	Green	M3	5.5	18.0	3.2	15.0	41	100	ERG2510
RZ4F	0.25–0.75	Green	M4	7.5	21.0	3.2	17.5	41	100	ERG2510
RA35F	0.5–1.5	Red	M3.5	5.5	21.0	4.0	17.5	62	100	ERG2001A, WT2124Y
RA4F	0.5–1.5	Red	M4	7.0	20.5	4.0	17.0	64	100	ERG2001A, WT2124Y
RA5F	0.5–1.5	Red	M5	9.0	22.5	4.0	18.0	75	100	ERG2001A, WT2124Y
RA6F	0.5–1.5	Red	M6	11.0	26.5	4.0	21.0	90	100	ERG2001A, WT2124Y
RB3F	1.5–2.5	Blue	M3	5.5	19.0	4.5	16.0	72	100	ERG2001A, WT2124Y
RB4F	1.5–2.5	Blue	M4	7.0	20.5	4.5	17.0	84	100	ERG2001A, WT2124Y
RB5F	1.5–2.5	Blue	M5	9.0	22.5	4.5	18.0	96	100	ERG2001A, WT2124Y
RB6F	1.5–2.5	Blue	M6	11.0	26.5	4.5	21.0	113	100	ERG2001A, WT2124Y
RC4F	4.0–6.0	Yellow	M4	8.0	24.0	6.4	20.5	159	100	ERG2001A, WT2124Y
RC5F	4.0–6.0	Yellow	M5	9.0	25.0	6.4	20.5	161	100	ERG2001A, WT2124Y
RC6F	4.0–6.0	Yellow	M6	11.0	28.5	6.4	23.0	174	100	ERG2001A, WT2124Y
RC8F	4.0–6.0	Yellow	M8	14.0	31.0	6.4	24.0	207	100	ERG2001A, WT2124Y
RC10F	4.0–6.0	Yellow	M10	18.0	36.0	6.4	27.0	280	100	ERG2001A, WT2124Y

Diagram

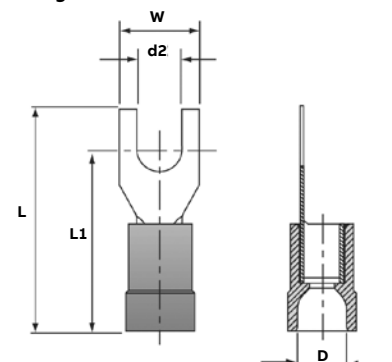

Vinyl-insulated ring terminals DIN 46237



Technical information

Material	Copper
Plating	Tin-plated
Marking	Wire size and bolt size stamped on the tongue
Metal barrel	Brazed seam to prevent barrel separation
Insulation	PVC = Polyvinylchloride (vinyl) Ideal for harsh environments, provides excellent chemical, impact and abrasion resistance
Max. electrical rating	75 °C 600 Volts max.
Colour coding of the insulation	According to the wire size

Cat. no.	Wire size range (mm ²)	Colour	Stud hole size d2	Dimensions (mm)			Wt. (g/100)	Qty. (pieces)	Crimping tool
				W	L1	D			
VB-3RR	0.5–1.5	Red	M3	6.0	17.2	4.0	68	100	ERG2001A, WT2124Y
VB-35RR	0.5–1.5		M3.5	6.0	17.2	4.0	69	100	ERG2001A, WT2124Y
VB-4RR	0.5–1.5		M4	8.0	18.2	4.0	73	100	ERG2001A, WT2124Y
VB-5RR	0.5–1.5		M5	10.0	19.2	4.0	92	100	ERG2001A, WT2124Y
VB-6RR	0.5–1.5		M6	10.0	19.2	4.0	87	100	ERG2001A, WT2124Y
VB-8RR	0.5–1.5		M8	14.0	23.2	4.0	139	100	ERG2001A, WT2124Y
VB-10RR	0.5–1.5		M10	14.0	23.2	4.0	100	100	ERG2001A, WT2124Y
VB-3BR	1.5–2.5	Blue	M3	6.0	17.5	4.5	80	100	ERG2001A, WT2124Y
VB-35BR	1.5–2.5		M3.5	6.0	17.5	4.5	94	100	ERG2001A, WT2124Y
VB-4BR	1.5–2.5		M4	8.0	18.5	4.5	83	100	ERG2001A, WT2124Y
VB-5BR	1.5–2.5		M5	10.0	20.5	4.5	110	100	ERG2001A, WT2124Y
VB-6BR	1.5–2.5		M6	11.0	22.5	4.5	122	100	ERG2001A, WT2124Y
VB-8BR	1.5–2.5		M8	14.0	23.5	4.5	146	100	ERG2001A, WT2124Y
VB-10BR	1.5–2.5		M10	15.0	23.5	4.5	204	100	ERG2001A, WT2124Y
VB-4YR	4.0–6.0	Yellow	M4	8.0	22.1	6.3	167	100	ERG2001A, WT2124Y
VB-5YR	4.0–6.0		M5	10.0	23.1	6.3	196	100	ERG2001A, WT2124Y
VB-6YR	4.0–6.0		M6	11.0	24.1	6.3	195	100	ERG2001A, WT2124Y
VB-8YR	4.0–6.0		M8	14.0	27.1	6.3	250	100	ERG2001A, WT2124Y
VB-10YR	4.0–6.0		M10	18.0	29.1	6.3	305	100	ERG2001A, WT2124Y

Diagram

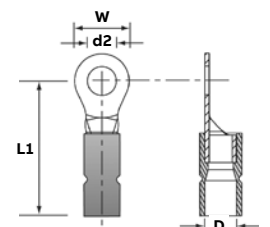

Nylon-insulated ring terminals DIN 46237



Technical information

Material	Copper
Plating	Tin-plated
Marking	Wire size and bolt size stamped on the tongue
Metal barrel	Brazed seam to prevent barrel separation
Insulation	PA = Polyamide Ideal for harsh environments, provides excellent chemical, impact and abrasion resistance
Temperature resistance	85 °C / 105 °C
Colour coding of the insulation	According to the wire size

Cat. no.	Wire size range (mm ²)	Colour	Stud hole size d2	Dimensions (mm)			Wt. (g/100)	Qty. (pieces)	Crimping tool
				W	L1	D			
TRA3	0.5–1.5	Red	M3	5.5	17.5	4.0	70	100	ERG2001A, WT2124Y
TRA35	0.5–1.5		M3.5	6.6	20.4	4.0	67	100	ERG2001A, WT2124Y
TRA4	0.5–1.5		M4	8.0	21.8	4.0	76	100	ERG2001A, WT2124Y
TRA5	0.5–1.5		M5	8.0	21.8	4.0	79	100	ERG2001A, WT2124Y
TRA6	0.5–1.5		M6	11.6	27.5	4.0	108	100	ERG2001A, WT2124Y
TRA8	0.5–1.5		M8	11.6	27.5	4.0	134	100	ERG2001A, WT2124Y
TRB3	1.5–2.5	Blue	M3	6.0	20.6	4.5	79	100	ERG2001A, WT2124Y
TRB35	1.5–2.5		M3.5	8.5	23.0	4.5	76	100	ERG2001A, WT2124Y
TRB4	1.5–2.5		M4	8.5	23.0	4.5	79	100	ERG2001A, WT2124Y
TRB5	1.5–2.5		M5	9.5	22.9	4.5	89	100	ERG2001A, WT2124Y
TRB6	1.5–2.5		M6	12.0	28.0	4.5	117	100	ERG2001A, WT2124Y
TRB8	1.5–2.5		M8	12.0	28.0	4.5	148	100	ERG2001A, WT2124Y
TRB10	1.5–2.5	M10	13.6	31.7	4.5	204	100	ERG2001A, WT2124Y	
TRC4-EU	4.0–6.0	Yellow	M4	7.4	26.7	6.4	158	100	ERG2001A, WT2124Y
TRC5-EU	4.0–6.0		M5	9.5	26.7	6.4	175	100	ERG2001A, WT2124Y
TRC6-EU	4.0–6.0		M6	12.0	32.7	6.4	187	100	ERG2001A, WT2124Y
TRC8	4.0–6.0		M8	15.0	34.9	6.4	230	100	ERG2001A, WT2124Y
TRC10	4.0–6.0		M10	15.0	34.9	6.4	296	100	ERG2001A, WT2124Y

Diagram

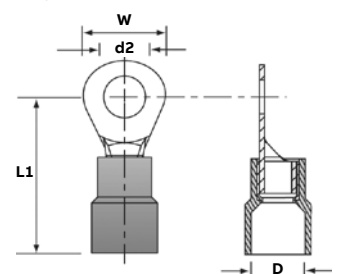

Nylon-insulated fork terminals DIN 46237



Technical information

Material	Copper
Plating	Tin-plated
Marking	Wire size and bolt size stamped on the tongue
Metal barrel	Brazed seam to prevent barrel separation
Insulation	PA = Polyamide Ideal for harsh environments, provides excellent chemical, impact and abrasion resistance
Temperature resistance	85 °C / 105 °C
Colour coding of the insulation	According to the wire size
Cable insertion	Easy entry

Cat. no.	Wire size range (mm ²)	Colour	Stud hole size d2	Dimensions (mm)			Wt. (g/100)	Qty. (pieces)	Crimping tool
				W	L1	D			
TRA3F	0.5–1.5	Red	M3	5.7	22.0	4.0	65	100	ERG2001A, WT2124Y
TRA35F	0.5–1.5		M3.5	6.2	22.0	4.0	62	100	ERG2001A, WT2124Y
TRA4F	0.5–1.5		M4	7.2	22.0	4.0	70	100	ERG2001A, WT2124Y
TRA5F	0.5–1.5		M5	8.0	22.0	4.0	92	100	ERG2001A, WT2124Y
TRA6F	0.5–1.5		M6	10.8	23.0	4.0	102	100	ERG2001A, WT2124Y
TRB3F	1.5–2.5	Blue	M3	5.7	22.2	4.5	81	100	ERG2001A, WT2124Y
TRB35F	1.5–2.5		M3.5	6.2	22.2	4.5	74	100	ERG2001A, WT2124Y
TRB4F	1.5–2.5		M4	7.2	22.2	4.5	80	100	ERG2001A, WT2124Y
TRB5F	1.5–2.5		M5	8.0	22.2	4.5	110	100	ERG2001A, WT2124Y
TRB6F	1.5–2.5		M6	10.8	23.5	4.5	122	100	ERG2001A, WT2124Y
TRC4F	4.0–6.0	Yellow	M4	8.2	26.7	6.4	163	100	ERG2001A, WT2124Y
TRC5F	4.0–6.0		M5	9.0	26.7	6.4	182	100	ERG2001A, WT2124Y
TRC6F	4.0–6.0		M6	12.0	30.3	6.4	190	100	ERG2001A, WT2124Y

Diagram

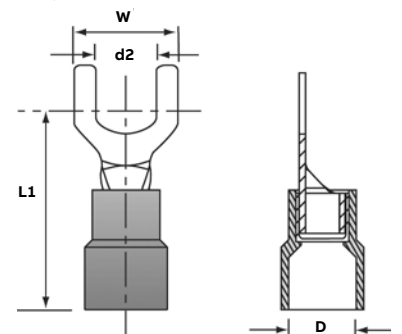

Vinyl-insulated fork terminals DIN 46237



Technical information

Material	Copper
Plating	Tin-plated
Marking	Wire size and bolt size stamped on the tongue
Metal barrel	Brazed seam to prevent barrel separation
Insulation	PVC = Polyvinylchloride (vinyl)
Max. electrical rating	75 °C 600 Volts
Colour coding of the insulation	According to the wire size
Cable insertion	Easy entry

Cat. no.	Wire size range (mm ²)	Colour	Stud hole size d2	Dimensions (mm)			Wt. (g/100)	Qty. (pieces)	Crimping Tool
				W	L1	D			
VB-4RF	0.5-1.5	Red	M4	6.8	18.2	4.0	73	100	ERG2001A
VB-5RF	0.5-1.5		M5	10.0	19.2	4.0	92	100	ERG2001A
VB-6RF	0.5-1.5		M6	11.0	21.2	4.0	103	100	ERG2001A
VB-3BF	1.5-2.5	Blue	M3	5.5	19.5	4.5	90	100	ERG2001A
VB-35BF	1.5-2.5		M3.5	6.0	17.5	4.5	97	100	ERG2001A
VB-4BF	1.5-2.5		M4	6.8	19.2	4.5	83	100	ERG2001A
VB-5BF	1.5-2.5		M5	10.0	20.5	4.5	110	100	ERG2001A
VB-6BF	1.5-2.5	M6	11.0	22.5	4.5	121	100	ERG2001A	
VB-4YF	2.5-6.0	Yellow	M4	8.0	22.1	6.3	169	100	ERG2001A
VB-5YF	2.5-6.0		M5	10.0	23.1	6.3	189	100	ERG2001A
VB-6YF	2.5-6.0		M6	11.0	24.1	6.3	200	100	ERG2001A
VB-8YF	2.5-6.0		M8	14.0	27.1	6.3	235	100	ERG2001A
VB-10YF	2.5-6.0		M10	18.0	29.1	6.3	305	100	ERG2001A

Diagram

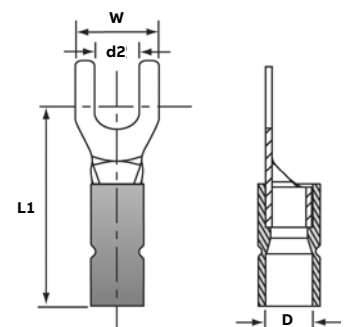

Polycarbonate-insulated pin terminals



Technical information

Material	Electrolytic copper
Plating	Tin-plated
Metal barrel	Brazed seam to prevent barrel separation
Insulation	PC = Polycarbonate
Temperature resistance	115 °C / 125 °C
Colour coding of the insulation	According to the wire size
Cable insertion	Easy entry

Cat. no.	Wire size range (mm ²)	Colour	Dimensions (mm)				Wt. (g/100)	Qty. (pieces)	Crimping tool
			L	F	B	D			
RZP	0.25–0.75	Green	22.0	12.0	1.8	3.2	47	100	ERG2510
RAP	0.5–1.5	Red	22.0	12.0	1.9	4.0	67	100	ERG2001A, WT2124Y
RBP	1.5–2.5	Blue	22.0	12.0	1.9	4.5	80	100	ERG2001A, WT2124Y
RCP	4.0–6.0	Yellow	27.0	14.0	2.8	6.4	175	100	ERG2001A, WT2124Y

Diagram

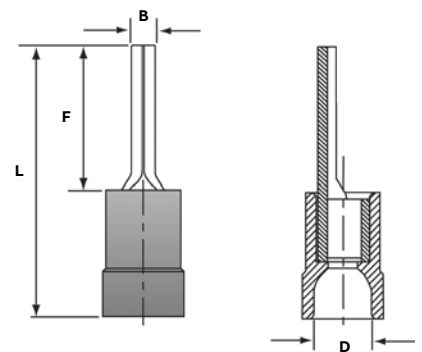

Insulated female disconnects DIN 46245



Technical information

Material	Brass
Plating	Tin-plated
Metal barrel	Brazed seam to prevent barrel separation
Insulation	PC = Polycarbonate
Temperature resistance	115 °C / 125 °C (for PVC insulation 65 °C / 75 °C)
Colour coding of the insulation	According to the wire size (DIN)
Cable insertion	Easy entry

Cat. no.	Wire size range (mm ²)	Male tab size (mm)	Colour	Dimensions (mm)			Wt. (g/100)	Qty. (pieces)	Crimping tool
				L	D	W			
RA28	0.5–1.5	2.8 x 0.8	Red	18.5	3.3	3.5	60	100	ERG2001A, WT2124Y
RA29	0.5–1.5	2.8 x 0.5		18.5	3.3	3.5	60	100	ERG2001A, WT2124Y
RA48**	0.5–1.5	4.8 x 0.8		19.0	3.7	5.7	82	100	ERG2001A, WT2124Y
RA49**	0.5–1.5	4.8 x 0.5		19.0	3.7	5.7	83	100	ERG2001A, WT2124Y
RA63	0.5–1.5	6.3 x 0.8		20.0	4.0	7.6	96	100	ERG2001A, WT2124Y
RB48**	1.5–2.5	4.8 x 0.5	Blue	19.0	4.4	5.7	91	100	ERG2001A, WT2124Y
RB49**	1.5–2.5	4.8 x 0.8		19.0	4.4	5.7	87	100	ERG2001A, WT2124Y
RB63	1.5–2.5	6.3 x 0.8		20.0	4.5	7.6	106	100	ERG2001A, WT2124Y
RC63	4.0–6.0	6.3 x 0.8	Yellow	24.0	6.4	7.6	183	100	ERG2001A, WT2124Y
RC95**	4.0–6.0	9.5 x 1.2		31.0	6.2	11.0	233	100	ERG2001A, WT2124Y

**Non-brazed, with support sleeve and PVC insulation, not easy entry

Diagram

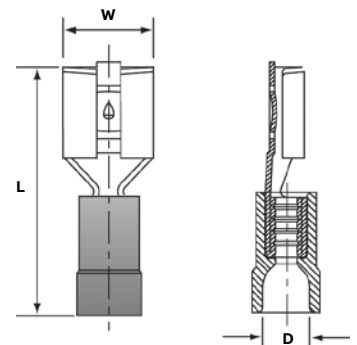

Insulated male disconnects DIN 46245



Technical information

Material	Brass
Plating	Tin-plated
Metal barrel	Brazed seam to prevent barrel separation
Insulation	PC = Polycarbonate
Temperature resistance	115 °C / 125 °C (for PVC insulation 65 °C / 75 °C)
Colour coding of the insulation	According to the wire size (DIN)
Cable insertion	Easy entry

Cat. no.	Wire size range (mm ²)	Male tab size (mm)	Colour	Dimensions (mm)		Wt. (g/100)	Qty. (pieces)	Crimping tool
				L	D			
RA63M	0.5–1.5	6.3 x 0.8	Red	22.0	4.0	107	100	ERG2001A, WT2124Y
RB63M	1.5–2.5	6.3 x 0.8	Blue	22.0	4.5	107	100	ERG2001A, WT2124Y
RC63M**	4.0–6.0	6.3 x 0.8	Yellow	25.0	6.3	155	100	ERG2001A, WT2124Y

**PVC insulation. No easy entry and non-brazed, with brass support sleeve

Diagram

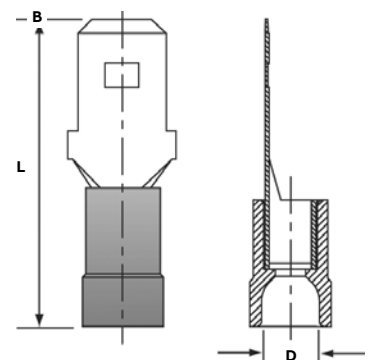

Fully insulated female disconnects DIN 46245



Technical information

Material	Brass
Plating	Tin-plated
Metal barrel	Non-brazed, with brass support sleeve
Insulation	PA = Polyamide Ideal for harsh environments, provides excellent chemical, impact and abrasion resistance
Temperature resistance	85 °C / 105 °C
Colour coding of the insulation	According to the wire size (DIN)

Cat. no.	Wire size range (mm ²)	Male tab size (mm)	Colour	Dimensions (mm)			Wt. (g/100)	Qty. (pieces)	Crimping tool
				W	L	D			
RA28V	0.5–1.5	2.8 x 0.8	Red	5.0	19.3	3.8	110	100	ERG2001A, WT2124Y
RA29V	0.5–1.5	2.8 x 0.5		5.0	19.3	3.8	110	100	ERG2001A, WT2124Y
RA48V	0.5–1.5	4.8 x 0.8		7.4	20.2	3.6	115	100	ERG2001A, WT2124Y
RA49V	0.5–1.5	4.8 x 0.5		7.4	20.2	3.6	115	100	ERG2001A, WT2124Y
RA63V**	0.5–1.5	6.3 x 0.8		8.8	21.0	4.0	123	100	ERG2001A, WT2124Y
RB48V	1.5–2.5	4.8 x 0.8	Blue	7.1	19.5	3.9	120	100	ERG2001A, WT2124Y
RB49V	1.5–2.5	4.8 x 0.5		7.1	19.5	3.9	120	100	ERG2001A, WT2124Y
RB63V**	1.5–2.5	6.3 x 0.8		8.8	21.0	4.5	132	100	ERG2001A, WT2124Y
RC63V	4.0–6.0	6.3 x 0.8	Yellow	9.0	26.0	5.3	215	100	ERG2001A, WT2124Y

**Easy entry and brazed barrel, polycarbonate insulator

Diagram

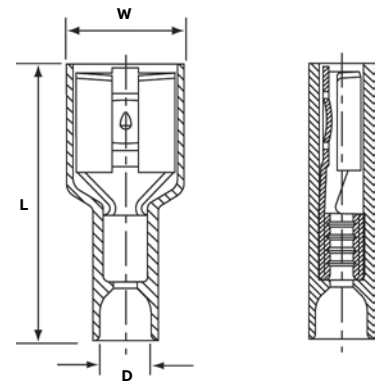

Fully insulated butt splices



Technical information

Material	Electrolytic copper
Plating	Tin-plated
Metal barrel	Brazed seam to prevent barrel separation
Insulation	PC = Polycarbonate
Temperature resistance	115 °C / 125 °C
Colour coding of the insulation	According to the wire size (DIN)
Cable insertion	Easy entry

Cat. no.	Wire size range (mm ²)	Colour	Dimensions (mm)		Wt. (g/100)	Qty. (pieces)	Crimping tool
			L	D			
RAA15	0.5–1.5	Red	24.0	3.4	97	100	ERG2001A, WT2124Y
RBB25	1.5–2.5	Blue	26.0	4.3	150	100	ERG2001A, WT2124Y
RCC6	4.0–6.0	Yellow	33.0	6.5	316	100	ERG2001A, WT2124Y

Diagram

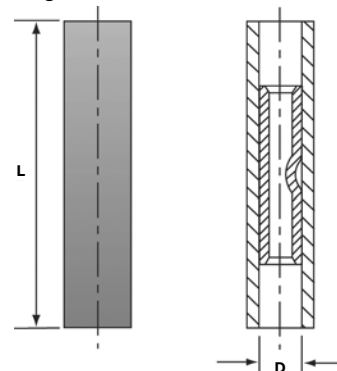

Insulated wire joints



Technical information

Material	Brass
Plating	Tin-plated
Metal barrel	Brazed seam to prevent barrel separation
Insulation	PA = Polyamide Ideal for harsh environments, provides excellent chemical, impact and abrasion resistance
Temperature resistance	85 °C / 105 °C

Cat. no.	Wire size range (mm ²)	Colour	Dimensions (mm)			Wt. (g/100)	Qty. (pieces)	Crimping tool
			F	L	D			
RBJ	1.0–3.0	White	8.0	15.2	6.4	86	100	ERG2001A, WT2124Y
RCJ	2.0–6.0		9.0	17.7	9.2	166	100	ERG2001A, WT2124Y

Diagram

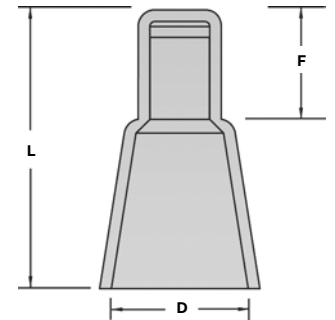

Tools

- Ergonomic ratchet-style hand tools used for installing insulated and non-insulated terminals
- Specially designed ergonomic handles distribute the crimping force more evenly across the user's hands, helping to reduce the risk of carpal tunnel syndrome, the cause of almost one in two industrial injuries
- Ratchet design greatly reduces handle forces over conventional hand tools and incorporates the Shure-Stake mechanism, which ensures a full crimp cycle every time
- Most dies incorporate wire range marking for easy inspection (insulated only)
- Colour-coded die nests (insulated only) make terminal and die nest selection easy
- The product design and engineering results in a long lasting precision tool
- Exists in 2 versions: with interchangeable dies or with fixed dies

Toggle action increases mechanical gain, which dramatically reduces handle force – and the stress on your hands

For easy visual verification of crimps, integrity dots are embossed on the top and bottom of the terminal

Colour-coded die nests on both the right and left sides of the tool are included for insulated terminals

Advanced ergonomic design of handle distributes the force more evenly across the hand

Rubberized thermoplastic handle combines maximum friction with a soft, comfortable feel that reduces muscle tension

Shure-Stake mechanism ensures a complete crimp cycle before it releases

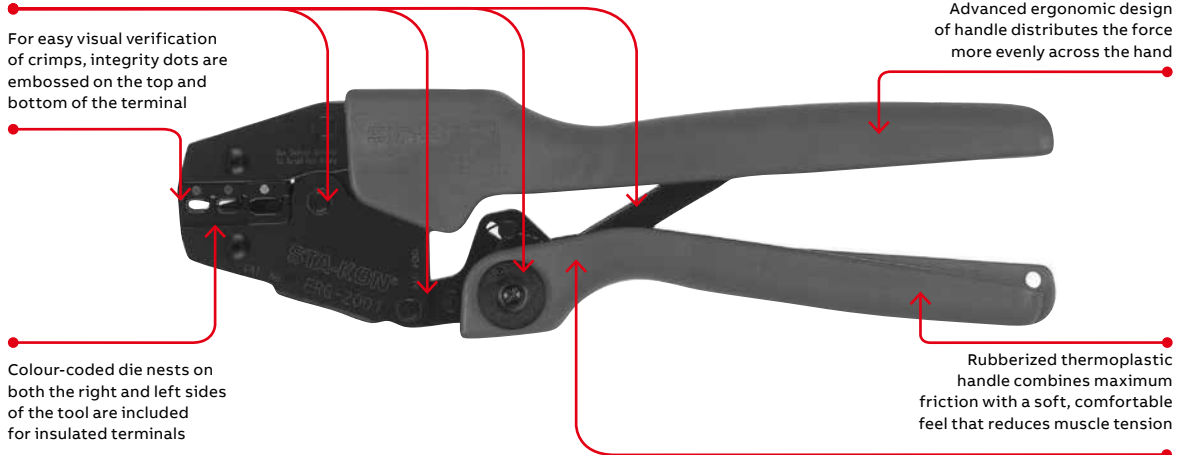

— 01 ERG2001A

— 02 ERG2510

Product ref.: ERG2001A

Ergonomic fixed die tool, with three colour-coded die nests for easy selection.

For insulated terminals from:

- 0.5 to 1.5 mm² red
- 1.5 to 2.5 mm² blue
- 4.0 to 6.0 mm² yellow

Shure-Stake mechanism

Length: 255 mm

Weight: 560 g



— 01

Product ref.: ERG2510

Ergonomic fixed die tool with 2 die nests.

For insulated terminals and insulated bootlace ferrules from:

- 0.25 to 0.5 mm²
- 0.5 to 1.0 mm²

Shure-Stake mechanism

Length: 220 mm

Weight: 430 g



— 02

Tools

Metric crimping tools

An extensive range of tooling is available, suiting a variety of requirements, to crimp the following terminals:

- Insulated terminals and bootlace ferrules
- Non-insulated terminals
- Copper tube terminals

Different types of tooling are offered, depending on volume and application:

- Plier-type hand tools for occasional applications (“do-it-yourself” users)
- Standard hand tooling for low to medium volume applications
- Ergonomic hand tooling for low to medium volume applications, where high, repeatable quality is essential
- Hydraulic tooling for heavy-duty applications
- Smart tools where no die change is necessary

—
01 WT52

—
02 WT2124Y

Product ref.: WT52

Plier-type tool.

For insulated and non-insulated terminals from 0.5 to 6.0 mm².

Incorporates wire stripper and bolt cutters. Recommended for “do-it-yourself” applications only.

Length: 225 mm

Weight: 200 g

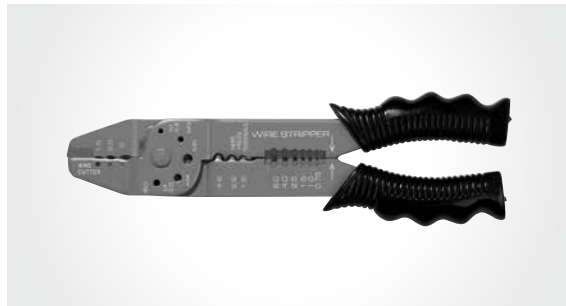

—
01

Product ref.: WT2124Y

Ratchet-type hand tool, fixed die.

For insulated and non-insulated terminals from:

- 0.5 to 1.5 mm² red
- 1.5 to 2.5 mm² blue
- 4.0 to 6.0 mm² yellow

Built in Shure-Stake mechanism to ensure a full compression every time.

Length: 228 mm

Weight: 533 g



—
02