

C

Blackburn®/Homac® - Compression connectors



—
C

Blackburn/Homac - Compression connectors

Table of contents

Section C

Compression H-tap connectors	C4
Distribution compression connectors	C12
Color-coded compression connectors	C14
Service wedge clamps	C26
Aluminum H-type compression connectors and covers	C28
Double-locking latches compression connectors and covers	C29
Aluminum lugs	C30
Aluminum splices	C47
Aluminum tapered tees	C54
Copper lugs	C56
Copper splices	C61
Copper tees	C64
Aluminum and copper lug tee taps	C67
Competitive cross reference	C68
Conductor reference	C75

Compression H-tap connectors

Type WR – Wide range aluminum tap connectors



“O” and “D” die seven connector program

- For combinations of aluminum-aluminum and aluminum-copper conductors
- Pass the requirements of ANSI C119.4
- Standard compression tools and dies install all sizes
- Seven Connector Program provides superior connector performance, lower connection costs and simplified installation procedures
- Fold-in tabs provide positive tab interlock as tool closes
- Field-proven ribbed design provides unparalleled connector/conductor contact, without distorting the conductor’s shape
- Made of 1350 aluminum alloy
- Pre-filled with an oxide inhibitor which is held captive in the rib/connection area
- For copper-to-copper combinations, use CF type shown on page 11

Type WR – Wide range aluminum tap connectors



Cat. no.	Connector no.	Conductor range (AWG or kcmil)										Installation information							
		Standard conductor						Compact conductor				Diameter (in.)	Connector length (in.)	No. indents					
		Main			Tap			Main		Tap				Max.	Min.	Max.	Min.	Connector die	Mech. tool
ACSR	Str.	Sol.	ACSR	Str.	Sol.	ACSR	Str.	ACSR	Str.	Max.	Min.	Max.	Min.						
WR159	1	2	1	2	2	1	2	2	1	2	1	0.332	0.162	0.332	0.162	1 ⁷ / ₁₆	0	4	2
		3	2	3	3	2	3	3	2	3	2								
		4	3	4	4	3	4	4	3	4	3								
		6	4	6	6	4	6	6	4	6	4								
WR189	2	1/0	2/0	3/0	2	1	1/0	2/0	2/0	1	1	0.419	0.266	0.332	0.162	1 ¹ / ₁₆	0	5	2
		1	1/0	2/0	3	2	1	1/0	1/0	2	2								
		2	1	1/0	4	3	2	1	1	3	3								
		3	2	1	6	4	3	2	2	4	4								
					6	4	6			6	6								
WR289	3	2/0	3/0	4/0	2	1	1/0	3/0	3/0	1	1	0.470	0.398	0.332	0.162	1 ¹ / ₁₆	D	5	2
		1/0	2/0	3/0	3	2	1	2/0		2	2								
					4	3	2			3	3								
					6	4	3			4	4								
					6	4	6			6	6								
WR279	4	2/0	3/0	4/0	2/0	3/0		3/0	3/0	3/0	3/0	0.470	0.336	0.470	0.36	1 ¹ / ₁₆	D	5	2
		1/0	2/0	3/0	1/0	2/0	3/0	2/0	2/0	2/0	2/0								
			1/0	2/0	1	1/0	2/0	1/0	1/0	1/0	1/0								
WR379	5	4/0	4/0	–	2	1	1/0	266 ¹ / ₄	266	1	1	0.563	0.475	0.332	0.162	1 ¹ / ₁₆	D	5	2
		3/0			3	2	1	250	250	2	2								
					4	3	2	4/0	4/0	3	3								
					6	4	3			4	4								
WR399	6	4/0	4/0	–	2/0	2/0	3/0	266 ¹ / ₄	266	2/0	3/0	0.563	0.461	0.447	0.338	2 ³ / ₁₆	D	6	2
		3/0	3/0		1/0	1/0	2/0	4/0	250	1/0	2/0								
					1			3/0	4/0	1/0	1/0								
WR419	7	4/0	4/0	–	4/0	4/0	–	266 ¹ / ₄	266	266	266	0.563	0.461	0.563	0.461	2 ⁷ / ₁₆	D	7	3
		3/0	3/0		3/0	3/0		4/0	250	18/1	250								
								3/0	4/0	4/0	4/0								

Diagrams

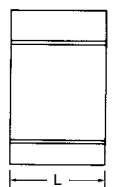
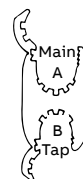

Compression H-tap connectors

Type WR – Wide range aluminum tap connectors



Supplemental “O” and “D” die seven connector program

- For combinations of aluminum-aluminum and aluminum-copper conductors
- Pass the requirements of ANSI C119.4
- Standard compression tools and dies install all sizes
- Seven Connector Program provides superior connector performance, lower connection costs and simplified installation procedures

- Fold-in tabs provide positive tab interlock as tool closes
- Field-proven ribbed design provides unparalleled connector/conductor contact, without distorting the conductor’s shape
- Made of 1350 aluminum alloy
- Pre-filled with an oxide inhibitor which is held captive in the rib/connection area
- For copper-to-copper combinations, use CF type shown on page 11

Type WR – Wide range aluminum tap connectors

Cat. no.	Conductor range (AWG or kcmil)												Connector length (in.)	Installation information				
	Standard conductor						Compact conductor							Connector die	No. indents			
	Main			Tap			Main			Tap					Mech. tool	Hyd. tool		
ACSR	Str.	Sol.	ACSR	Str.	Sol.	ACSR	Str.	ACSR	Str.	ACSR	Str.	Max.	Min.	Max.			Min.	Diameter (in.)
WR149	4	3	2	4	3	2	4	2	3	2	0.266	0.162	0.266	0.162	1½	0	5	
	6	4	3	6	4	3	6	3	4	3								
		6	4	6	6	4	6	4	6	4								
WR179	1/0	1/0	1	4	3	2	1/0	2/0	4	2	0.398	0.266	0.266	0.162	1¾	0	5	2
	1	1		6	4	3	1	1/0	6	3								
	2	2			6	4	2	1		4								
	3					6	2	2		6								
WR199	1/0	1/0	1	2	1	1	2/0	1	1	0.398	0.066	0.332	0.232	1¾	0	5	2	
	1	1		3	2	2	1/0	2	2									
	2	2		4	3			1	3									
	3				4			2	4									
WR1010	1/0	2/0	1	1/0	2/0	1	2/0	2/0	2/0	2/0	0.419	0.232	0.419	0.232	1¾	0	4	2
	1	1/0	2	1	1/0	2	1/0	1/0	1/0	1/0								
	2	1		2	1		1	1	1	1								
	3	2		3	2		2	2	2	2								
	4	3		4	3		3		3	3								
WR259	1/0	2/0	-	1/0	2/0	-	2/0	2/0	2/0	2/0	0.419	0.326	0.412	0.292	1½	D	5	2
	1	1/0		1	1/0		1/0	1/0	1/0	1/0								
WR299	2/0	3/0	-	4	3	2	3/0	3/0	4	2	0.470	0.398	0.266	0.162	1½	D	4	2
	1/0	2/0		6	4	3	2/0		6	3								
WR219	1/0	1/0	-	1/0	1/0	-	1/0	2/0	1/0	2/0	0.398	0.324	0.398	0.316	1½	D	5	2
	1	1		1	1		1/0	1/0	1/0	1/0								
WR239	2/0	2/0	-	2	1	1	2/0	4/0	1	1	0.447	0.365	0.332	0.236	1½	D	5	2
	1/0	1/0		3	2	2	1/0	3/0	2	2								
WR229	2/0	3/0	-	1/0	1/0	-	3/0	3/0	1/0	2/0	0.470	0.410	0.398	0.316	1½	D	5	2
		2/0		1	1		2/0		1	1/0								
WR269	2/0	2/0	-	2/0	2/0	-	2/0	3/0	2/0	3/0	0.447	0.410	0.447	0.336	1½	D	5	2
				1/0	1/0				1/0	2/0								

Diagrams

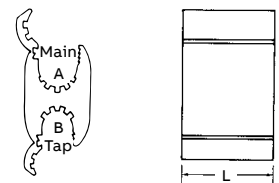

Compression H-tap connectors

Type WR – Wide range aluminum tap connectors



Supplemental “O” and “D” die seven connector program

- For combinations of aluminum-aluminum and aluminum-copper conductors
- Pass the requirements of ANSI C119.4
- Standard compression tools and dies install all sizes
- Seven Connector Program provides superior connector performance, lower connection costs and simplified installation procedures
- Fold-in tabs provide positive tab interlock as tool closes
- Field-proven ribbed design provides unparalleled connector/conductor contact, without distorting the conductor’s shape
- Made of 1350 aluminum alloy
- Pre-filled with an oxide inhibitor which is held captive in the rib/connection area
- For copper-to-copper combinations, use CF type shown on page 11

Type WR – Wide range aluminum tap connectors

Cat. no.	Conductor range (AWG or kcmil)										Installation information							
	Standard conductor*						Compact conductor				Diameter (in.)	Connector length (in.)	No. indents					
	Main		Tap		Main		Tap		Max.	Min.			Max.	Min.	Connector die	Mech. tool	Hyd. tool	
ACSR	Str.	Sol.	ACSR	Str.	Sol.	ACSR	Str.	ACSR			Str.	Max.						Min.
WR319	3/0	3/0	-	2	1	1	3/0	4/0	1	1	0.502	0.461	0.332	0.229	1 7/8	D	5	2
				3	2	2			2	2								
				4	3				3									
WR339	3/0	3/0	-	2/0	2/0	-	3/0	4/0	2/0	3/0	0.502	0.461	0.447	0.336	2 1/8	D	6	2
				1/0	1/0				1/0	2/0								
				1					1/0	1/0								
WR359	4/0	4/0	-	4	3	2	266	266	1/0	1/0	0.563	0.461	0.266	0.162	1 7/8	D	4	2
	3/0	3/0		6	4	3	4/0	250	1	1								
					6	4	3/0	4/0	2	2								
WR369	4/0	4/0	-	1	1/0	1	266	266	1/0	1/0	0.563	0.461	0.374	0.266	1 7/8	D	4	2
	3/0	3/0		2	1		4/0	250	1	1								
				3	2		3/0	4/0	2	2								
WR369**	4/0	4/0	-	1/0	1/0	1/0	266	266	1/0	1/0	0.63	0.423	0.3763	0.232	1 7/8	D	5	2
	3/0	3/0		1	1	1	4/0	250	1	1								
	2/0			2	2	2	3/0	4/0	2	2								
WR389	4/0	4/0	-	2/0	3/0	-	266	266	3/0	3/0	0.563	0.461	0.470	0.376	2 3/16	D	6	2
	3/0	3/0		1/0	2/0		4/0	250	2/0	2/0								
							3/0	4/0										
WR389**	4/0	4/0	-	2/0	3/0	-	266	266	3/0	3/0	0.563	0.423	0.470	0.336	2 3/16	D	6	2
	3/0	3/0		1/0	2/0		4/0	250	2/0	2/0								
	2/0			1	1/0		3/0	4/0	1/0	1/0								

Diagrams

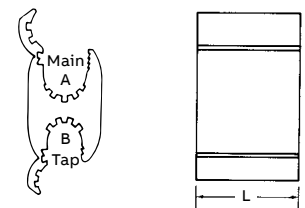

*Will accept conductors of these same wire sizes with a 3% reduction of diameter (compressed).

**This range possible only when crimped with hydraulic tool TBM14M or JB12B.

Products on this page are not CSA applicable.

Compression H-tap connectors

Type WR – Wide range aluminum tap connectors “N” die for hydraulic tools, 12-ton and greater



- For combinations of aluminum-aluminum and aluminum-copper conductors
- Pass the requirements of ANSI C119.4
- Standard compression tools and dies install all sizes
- Seven Connector Program provides superior connector performance, lower connection costs and simplified installation procedures
- Fold-in tabs provide positive tab interlock as tool closes
- Field-proven ribbed design provides unparalleled connector/conductor contact, without distorting the conductor’s shape
- Made of 1350 aluminum alloy
- Pre-filled with an oxide inhibitor which is held captive in the rib/connection area
- For copper-to-copper combinations, use CF type shown on page 11

Type WR – Wide range aluminum tap connectors “N” die for hydraulic tools, 12-ton and greater

Cat. No.	Conductor range (AWG or kcmil)														Con- nector length (in.)	Installation information	
	Standard conductor*						Compact conductor				Diameter (in.)					For use with tool	No. of in- dents
	Main		Tap		Sol.		Main		Tap		Main		Tap				
ACSR	Str.	ACSR	Str.	ACSR	Str.	ACSR	Str.	ACSR	Str.	Max.	Min.	Max.	Min.				
WR715	397 ^{1/4}	400 300	2/0	2/0	3/0 3	477	500	2/0 3/0	3	0.753	0.520	0.447	0.162	2	TBM12, JB12B et Y-35	2	
	336	397 266	1/0	1/0	2/0 4	397	477	1/0 2/0	4								
	266	350 250	1	1	1/0 6	336	394	1 1/0	6								
	336		2	2	1		350	2 1									
			3	3	2			3 2									
WR775	397 ^{1/4}	400 0	397 ^{1/4}	400 300	-	477	500 336	477 500	300	0.743	0.520	0.743	0.520	3	TBM12, JB12B et Y-35	3	
	336	397 266	336	397 266		397	400 300	397 400	266								
	266	350 250	266	350 250		336	397 266	336 397	250								
	336	4/0	4/0	336 4/0		266	350 250	266 336									
	30																
WR815	477 ^{1/4}	556 350	2/0	400 300	3/0 1	556	556 336	2/0 3/0	3	0.858	0.520	0.447	0.162	2	TBM12, JB12B et Y-35	2	
	397	500 336	1/0	397 266	2/0 2	477	477 266	1/0 2/0	4								
	336	400 300	1	350 250	1/0 3	397	397 250	1 1/0	6								
	266	397 266	2	336 4/0	4	350	350	2 1									
	4/0	250	3		6	336		3 2									
WR835	477 ^{1/4}	556 350	4/0	4/0	4/0	556	556 336	266 250	3	0.858	0.520	0.563	0.368	2	TBM12, JB12B et Y-35	2	
	397	500 336	3/0	3/0	3/0	477	500 300	4/0 4/0	4								
	336	400 300	2/0	2/0	2/0	397	400 266	3/0 3/0	6								
	266	397 266	1/0	1/0		350	397 250	2/0									
	4/0	250				336	350										
WR875**	477 ^{1/4}	556 350	477 ^{1/4}	350	397	556	556 336	397 400	300	0.858	0.520	0.684	0.520	3	TBM12, JB12B et Y-35	3	
	397	500 336	266	336	366	477	500 300	336 397	266								
	336	400 300		300		397	400 266	266 350	250								
	266	397 266		266		350	397 250	336									
	4/0	250		250		336	350										
WR885	477 ^{1/4}	500 300	477 ^{1/4}	500 300	397	556	556 336	556 556	300	0.814	0.520	0.814	0.520	3	TBM12, JB12B et Y-35	3	
	397	400 266	397	400 266	366	477	500 300	477 477	266								
	336	397 250	336	397 250		397	400 266	394 397	250								
	266	350 4/0	266	350 4/0		350	397 250	336 350									
	4/0	336	4/0			336	350	266 336									

Diagrams

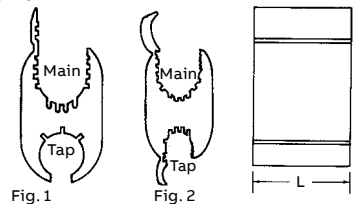

* Will accept conductors of these same wire sizes with a 3% reduction of diameter (compressed). ** Not reversible (Fig. 2).
Products on this page are not CSA applicable.

Compression H-tap connectors

Type WR – Wide range aluminum tap connectors “N” die for hydraulic tools, 10-ton and greater



- For combinations of aluminum-aluminum and aluminum-copper conductors
- Pass the requirements of ANSI C119.4
- Standard compression tools and dies install all sizes
- Seven Connector Program provides superior connector performance, lower connection costs and simplified installation procedures
- Fold-in tabs provide positive tab interlock as tool closes
- Field-proven ribbed design provides unparalleled connector/conductor contact, without distorting the conductor’s shape
- Made of 1350 aluminum alloy
- Pre-filled with an oxide inhibitor which is held captive in the rib/connection area
- For copper-to-copper combinations, use CF type shown on page 11

Type WR – Wide range aluminum tap connectors “N” die for hydraulic tools, 10-ton and greater

Cat. no.	Standard conductor*										Conductor range (AWG or kcmil)				Con- nector length (in.)	Installation information		
	Main					Tap					Main		Tap			For use with tool	No. of in- dents	
	ACSR	Str.	ACSR	Str.	Sol.	ACSR	Str.	ACSR	Str.	ACSR	Str.	Max.	Min.	Max.				Min.
WR699	397 ¹⁸ / ₄ 336 266 336	400 397 350 250	300 266 250	4 6 6 6	3 4 4 6	2 3 4 6	477 397 350 336	477 397 350 336	336 300 350	4 6 4 6	2 3 4 6	0.743 0.570	0.570	0.266 0.162	0.162	2	TBM12, JB12B and 13642M	2
WR719	397 ¹⁸ / ₄ 336 266 336	400 397 350 250	300 266 250	2/0 1/0 1 2 3	2/0 1/0 1 2 1	3/0 2/0 1/0 1	477 397 350 336	477 397 350 336	336 300 350	2/0 1/0 1 2	3/0 2/0 1/0 2	0.743 0.570	0.570	0.447 0.289	0.289	2	TBM12, JB12B and 13642M	2
WR739	397 ¹⁸ / ₄ 336 266 336	400 397 350 250	300 266 250	4/0 3/0 2/0 1/0	4/0 3/0 2/0	4/0	477 397 350 336	477 397 350 336	336 300 350	266 266 3/0 4/0	266 250 4/0	0.743 0.570	0.570	0.563 0.398	0.398	2	TBM12, JB12B and 13642M	2
WR779	397 ¹⁸ / ₄ 336 266 336	400 397 350 250	300 266 250	397 ¹⁸ / ₄ 336 266	400 397 350 250	336 266 250	477 397 350 336	477 397 350 336	336 300 350	477 397 397 336	477 397 397 336	0.743 0.570	0.570	0.743 0.570	0.570	3	TBM12, JB12B and 13642M	3
WR799	477 ¹⁸ / ₄ 266	500 250	4 6	3 4 6	3 4 4 6	2 3 4 6	477 ¹⁸ / ₄ 250	500 250	3 4 6	2 3 4 6	2 3 4 6	0.814 0.575	0.575	0.270 0.160	0.160	2	TBM12, JB12B and 13642M	2
WR819	477 ¹⁸ / ₄ 397 336 450	556 500 397 350 336	400 397 350	2/0 1/0 1 2 3	2/0 1/0 1 2 2	3/0 2/0 1/0 1	556 477 397	556 477 397	2/0 1/0 1 2	3/0 2/0 1/0 2	3/0 2/0 1/0 2	0.858 0.659	0.659	0.477 0.289	0.289	2	TBM12, JB12B and 13642M	2
WR839	477 ¹⁸ / ₄ 397 336 450	556 500 397 350 336	400 397 350	4/0 3/0 2/0	4/0 3/0	4/0	556 477 397	556 477 397	266 4/0 3/0	266 250 4/0	266 250 4/0	0.858 0.659	0.659	0.563 0.477	0.477	2	TBM12, JB12B and 13642M	2
WR879**	477 ¹⁸ / ₄ 397 336 450	556 500 397 350 336	400 397 350	336 ¹⁸ / ₄ 266	350 336 300 266	397	556 477 397	556 477 397	397 336 397	397 350 336	397 350 336	0.858 0.659	0.659	0.684 0.593	0.593	2	TBM12, JB12B and 13642M	3
WR889	477 ¹⁸ / ₄ 397 336	500 400 397 350 336	477 ¹⁸ / ₄ 397 336	500 400 397 350 336	500 400 397 350 336	–	556 477 397 336	556 477 397 350	556 477 397 336	556 477 397 350	556 477 397 350	0.814 0.666	0.666	0.814 0.666	0.666	2	TBM12, JB12B and 13642M	3

Diagrams

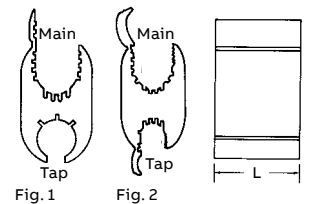

*Will accept conductors of these same wire sizes with a 3% reduction of diameter (compressed). **Not reversible (Fig. 2).
Products on this page are not CSA applicable.

Compression H-tap connectors

Type WR – Wide range aluminum tap connectors “R” die seven connector program



- For combinations of aluminum-aluminum and aluminum-copper conductors
- Pass the requirements of ANSI C119.4
- Standard compression tools and dies install all sizes
- Seven Connector Program provides superior connector performance, lower connection costs and simplified installation procedures
- Fold-in tabs provide positive tab interlock as tool closes
- Field-proven ribbed design provides unparalleled connector/conductor contact, without distorting the conductor’s shape
- Made of 1350 aluminum alloy
- Pre-filled with an oxide inhibitor which is held captive in the rib/connection area
- For copper-to-copper combinations, use CF type shown on page 11

Type WR – Wide range aluminum tap connectors “R” die seven connector program

Cat. no.	Calibres de conducteurs (AWG ou kcmil)												Con- tor length (in.)	Installation information									
	Standard conductor				Compact conductor				Diameter (in.)					For use with tool	Con- nector die	No. of indents							
	Main		Tap		Main		Tap		Main		Tap												
ACSR	Str.	ACSR	Str.	ACSR	Str.	ACSR	Str.	Max.	Min.	Max.	Min.	Max.	Min.										
WR909	556 ¹ / ₄	600	450	336 ¹ / ₄	350	4/0	636	700	397 ¹ / ₂	397	0.893	0.666	0.684	0.398	4 ³ / ₄	TBM151 (15620)	R	4					
	477	556	400	266	336	3/0	556	636	336	350													
	397	550	397	4/0	266	2/0	477	556	266	336													
	336	500	350	3/0	250		397	500	4/0	300													
	300	400	336	2/0			477	477	3/0	266													
	477		1/0			450	2/0	250	4/0														
								3/0															
WR929	556 ¹ / ₄	600	450	556 ¹ / ₄	600	450	636	700	636	700	0.893	0.666	0.893	0.666	4 ³ / ₄	TBM151 (15620)	R	4					
	477	556	400	477	556	400	556	636	556	636													
	397	550	397	397	550	397	477	556	477	556													
	336	500	350	336	500	350	397	500	397	477													
	300	400	336	300	477	336		477	450	450													
	477																						
WR949	795 ² / ₇	900	715	336 ¹ / ₄	350	954	1,000	397 ¹ / ₄	397	1.108	0.883	0.684	0.398	4 ³ / ₄	TBM151 (15620)	R	4						
	715	874	700	266	336	874	954	336	350														
	666	800	636	4/0	266	795	874	266	336														
	636	795	600	3/0	250	795	795	4/0	300														
	606	750		2/0	4/0	750	750	3/0	266														
	556			1/0	3/0			2/0	250														
	477 ³ / ₄				2/0				4/0														
								3/0															
WR969	795 ² / ₇	900	715	556 ¹ / ₄	600	450	954	1,000	636	700	1.108	0.883	0.893	0.666	4 ³ / ₄	TBM151 (15620)	R	4					
	715	874	700	477	556	400	874	954	556	363													
	666	800	636	397	550	397	795	874	477	556													
	636	795	600	336	500	350	795	795	397	477													
	606	750		300	477	336	750	750	450	450													
	556																						
477 ³ / ₄																							
WR989	795 ² / ₇	900	715	795 ² / ₇	900	715	954	1,000	954	1,000	1.108	0.883	1.108	0.883	4 ³ / ₄	TBM151 (15620)	R	4					
	715	874	700	715	874	700	874	954	874	954													
	666	800	636	666	800	636	795	874	795	874													
	636	795	600	636	795	600	795	795	795	795													
	606	750		605	750		750	750	750	750													
	556			556																			
477 ³ / ₄			477 ³ / ₄																				
WR999	954 ⁴ / ₇	1,033	1,033	954 ⁴ / ₇	1,033	954	1,000	954	1,000	1.172	0.997	1.172	0.997	4 ³ / ₄	TBM151 (15620)	R	4						
	900	1,000	1,000	900	1,000	900	900	900	900														
	874	900	900	874	900			874															
	795	800	800	7985	800																		
	715	795	795	715	795																		
666	750	750	666	750																			

Diagrams

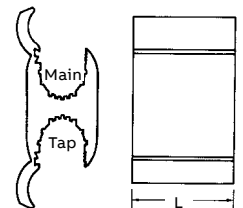

Compression H-tap connectors

Type WR – Street lighting compression connectors



Type WR – Street lighting compression connectors

Cat. no.	Figure no.	Conductor range (AWG or kcmil)												Connector length (in.)	Installation information			
		Standard conductor						Diameter (in.)							For use with tool	No. of indents		
		Main		Tap A		Tap B		Main		Tap A		Tap B				Mech. tool	Hyd. tool	
ACSR	Str.	Sol.	Str.	Sol.	Str.	Sol.	Str.	Sol.	Max.	Min.	Max.	Min.	Max.	Min.				
WR9**	2	3	2	1	8	8	-	-	0.292	0.184	0.146	0.064	-	-	13/16	5/8 BG	3	-
		4	3	2	10	10												
		6	4	3	12	12												
WR139	1	1/0	2/0	1	8	6	12	12	0.419	0.250	0.162	0.100	0.092	0.064	1 1/2	0	4	2
		1	1/0	2	10	8	14	14										
		2	1			10												
		3	2															
		4	3															
WR502	1	4/0	4/0	-	8	6	12	12	0.563	0.461	0.162	0.100	0.092	0.064	1 1/2	D	4	-
		3/0	3/0		10	8	14	14										
WR502*	1	4/0	4/0	-	8	6	12	12	0.563	0.365	0.162	0.100	0.092	0.064	1 1/2	D	-	2
		3/0	3/0		10	8	14	14										
		2/0	2/0			10												
		1/0	1/0															

Diagrams

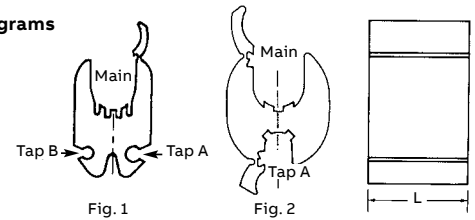

Will accept conductors of these same wire sizes with a 3% reduction of diameter (compressed).

* This range possible only when crimped with hydraulic tool TBM14M or JB12B.

** CSA certified.

Products on this page are not CSA applicable.

Compression H-tap connectors

Type CF – Copper compression tap connectors



- For tapping copper conductors to unbroken main copper conductors
- Extruded pure electrolytic copper
- Full length tab for easy installation
- Efficient design for lower crimping force
- Standard compression tools and dies
- Single and double tab designs

Type CF – Copper compression tap connectors

Cat. no.	Figure no.	Conductor range (AWG or kcmil)								Dimensional information		Installation information							
		Standard conductor*		Diameter (in.)*				H	H Connector 1 length (in.)	Mechanical tools***			Hydraulic tools***						
		Main A	Tap B	Main A	Tap B	Max.	Min.			Type	MD	H	TBM15/Y45/Y46						
ACS	Str.	Sol.	Str.	Max.	Min.	Max.	Min.	(Min.)	OD 58	0 Series	JB12B Series	Y-35	Y45/Y46						
CF44-1	1	4 6	6	4 6 8	6	0.204	0.162	0.204	0.128	0.971	0.729	13/16	B, T 5/8	B, T 5/8	W-KB W-BG	BKT	B U-BG	BKT U-BG	
CFS44-1	2	4 6	6	4 6 8	8	0.204	0.162	0.204	0.128	0.864	0.743	13/16	B, T 5/8	B, T 5/8	W-KB W-BG	BKT	BKT U-BG	BKT U-BG	
CF22-1	1	2 4	4	2 4	4	0.258	0.204	0.258	0.204	1.162	0.813	13/16	K	K	W-KK	-	-	-	BKT
CFS22-1	2	2 4	4	2 6	6	0.258	0.204	0.258	0.162	1.017	0.842	13/16	K	K	W-KK	HBKC	BKT	BKT	BKT
CF102-1	1	-	1/0 1 2	2 4 6	4	0.373	0.292	0.258	0.162	1.540	1.100	27/32	-	-	-	0	0	0	0
CF1010-1	1	-	1/0 1 2	-	1/0 1 2	0.373	0.292	0.373	0.292	1.610	1.050	27/32	-	-	-	0	0	0	0
CF202-1	1	-	2/0 1/0	-	2/0 1/0 1 2	0.419	0.368	0.259	0.204	1.670	1.269	7/8	-	-	-	K-C	C	K-C	BK-C
CF2020-1	1	-	2/0 1/0	-	2/0 1/0 1 2	0.419	0.368	0.414	0.292	1.740	1.220	7/8	-	-	-	K-C	C	K-C	BK-C
CF402-1	1	-	4/0 3/0 2/0	2 4	4	0.528	0.414	0.259	0.204	1.983	1.423	1 1/8	-	-	-	D**	D**	D**	D**
CF4010-1	1	-	4/0 3/0 2/0	-	1/0 1 2	0.528	0.414	0.373	0.292	1.992	1.423	1 1/8	-	-	-	D**	D**	D**	D**
CF4040-1	1	-	4/0 3/0 2/0	-	4/0 3/0 2/0	0.528	0.414	0.528	0.414	2.252	1.483	1 1/8	-	-	-	D**	D**	D**	D**

Diagrams

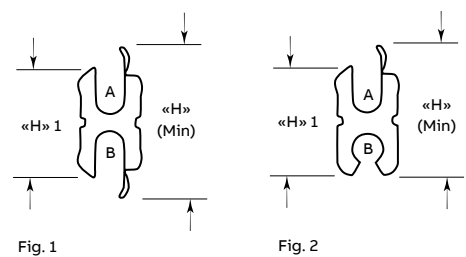

*Decimal dimensions are for conventional conductor, not Copperweld or Alumoweld.

**Blackburn "D" dies.

***Three indents with mechanical tools and one indent with hydraulic tools. 15-Ton/head use appropriate die adapters.

Distribution compression connectors

Type AL – Aluminum compression terminal lugs



- For aluminum and copper conductor
- NEMA standard mounting holes
- Prefilled with oxide inhibitor
- Complete die and crimp information clearly indented on each lug
- Install with standard tools and dies
- Use 1/2" mounting hardware for all sizes
- Available tin plated (add suffix P to catalogue number)
- Extended barrel for additional crimping area or weather-seal for outdoor terminators

Type AL – Aluminum compression terminal lugs

Cat. no.	Conductor range (AWG or kcmil)					Diameter (in.)		Installation dies		Dimensions (in.)		
	2 hole (fig. 1)	1 hole (fig. 2)	ACSR	AWG (stranded)	Compact	Min.	Max.	Mech. tool	Hyd. tool	W	L	T (pad thickness)
AL4	–		2	1–2	–	0.316	0.332	840	840	1 1/4	5 7/8	5/16
–	AL5		1/0	1/0	2/0	0.368	0.398	K840	B49EA	1 1/4	4 7/8	13/32
AL6	–		1/0	1/0	2/0	0.368	0.398	845	EEl, 11A	1 1/4	6 5/8	13/32
–	AL7		2/0	2/0	3/0	0.414	0.447	TX	K840	1 1/4	6 5/8	13/32
AL8	–		2/0	2/0	3/0	0.414	0.447		249	1 1/4	4 7/8	11/32
–	AL9		3/0	3/0	4/0	0.464	0.502		76	1 1/4	6 5/8	11/32
AL10	–		3/0	3/0	4/0	0.464	0.502		CSA 24	1 1/4	4 7/8	5/16
–	AL11		4/0	4/0	–	0.522	0.563			1 1/4	4 7/8	9/32
AL12	–		4/0	4/0	–	0.522	0.563			1 1/4	6 5/8	9/32
AL16			266 ²⁶ / ₇ , 6/7, 1 ¹⁸ / ₄	250–300	–	0.574	0.679	–	B80EA	1 1/2	7 7/8	7/16
AL18			266 ²⁶ / ₇ , 6/7, 1 ¹⁸ / ₄ , 336 ¹⁸ / ₄	300–350	450 kcmil	0.609	0.772	–	EEl 13A	1 9/16	7 7/8	13/32
AL20			336 ³⁰ / ₇ , 2 ²⁶ / ₇ , 1 ¹⁸ / ₄ , 397 ¹⁸ / ₄	336–400	500 kcmil	0.666	0.813	–	655	1 1/8	7 7/8	3/8
									1 1/8	1 9/16	7 7/8	3/8
									96H	1 9/16	7 7/8	3/8
									CSA 26	1 9/16	8 1/8	1/2
AL24			397 ³⁰ / ₇ , 2 ²⁶ / ₇ , 1 ¹⁸ / ₄ , 477 ¹⁸ / ₄	450–500	600 kcmil	0.770	0.893	–	106H	1 9/16	8 1/8	1/2
AL28			477 ³⁰ / ₇ , 2 ²⁶ / ₇ , 1 ¹⁸ / ₄ , 556 ¹⁸ / ₄	550 and 556	–	0.846	0.964	–	CSA 28	1 9/16	8 1/8	1/2
AL32			556 ²⁶ / ₇ , 2 ²⁴ / ₇ , 636 ¹⁸ / ₄	600 and 636	750 kcmil	0.891	0.990	–	B20AH	1 9/16	8 1/8	1/2
									EEl 14A	1 9/16	8 1/8	1/2
									318	1 9/16	8 1/8	1/2
									1 9/16	1 9/16	8 1/8	1/2
AL44			636 ²⁶ / ₇ , 715 ⁵⁴ / ₇ , 666 ²⁴ / ₇	750–800	–	0.990	1.031	–				1/2
AL60*			922 ⁵⁴ / ₇ , 954 ⁴⁸ / ₇	1,000–1,033	–	1.151	1.165	–				1/2

Diagrams

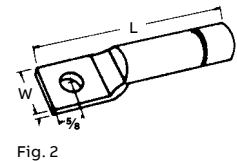
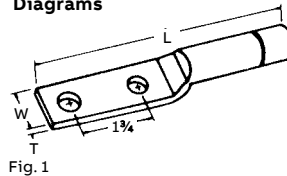

* For aluminum conductor only

Distribution compression connectors

Type ALS – Aluminum compression terminal lugs



- For aluminum and copper conductor
- NEMA standard mounting holes
- Prefilled with oxide inhibitor
- Complete die and crimp information clearly indented on each lug
- Install with standard tools and dies
- Use ½" mounting hardware for all sizes
- Available tin plated (add suffix P to catalogue number)

Type ALS – Aluminum compression terminal lugs

Cat. no.		Conductor range (AWG or kcmil)					Installation dies		Dimensions (in.)		
2 hole (fig. 1)	1 hole (fig. 2)	ACSR	AWG (stranded)	Compact	Diameter (in.)		Mech. tool	Hyd. tool	W	L	T (pad thickness)
					Min.	Max.					
-	AL581	4	4	-	0.277	0.213	5/8	B58CS	29/32	237/64	1/4
AL582	-	4	4	-	0.277	0.213	Peach BG WBG	U-BG	29/32	437/64	1/4
-	AL583	2	2	-	0.344	0.290	G		29/32	237/64	1/4
AL584	-	2	2	-	0.344	0.290	TU		29/32	437/64	1/4
-	AL585	1/0	1/0	2/0	0.422	0.381			29/32	237/64	1/4
AL586	-	1/0	1/0	2/0	0.422	0.381			29/32	437/64	1/4
-	ALS1	4	4, 2 Solid	4	0.258	0.232	840	840	29/32	3 3/4	1/4
ALS2	-	4	4, 2 Solid	4	0.258	0.232	K840	B49EA	1 3/4	5 3/4	1/4
-	ALS3	2	1-2	1-2	0.332	0.316	845	EEL 11A	29/32	3 3/4	1/4
ALS4	-	2	1-2	1-2	0.332	0.316	TX	K840	29/32	3 3/4	1/4
-	ALS5	1/0	1/0	2/0	0.398	0.368		249	1 3/4	5 3/4	1/4
ALS6	-	1/0	1/0	2/0	0.398	0.368		76	29/32	3 3/4	1/4
-	ALS7	2/0	2/0	3/0	0.447	0.414		CSA24	1 3/4	5 3/4	1/4
ALS8	-	2/0	2/0	3/0	0.447	0.414			29/32	3 3/4	1/4
-	ALS9	3/0	3/0	4/0	0.502	0.464			1 3/4	5 3/4	1/4
ALS10	-	3/0	3/0	4/0	0.502	0.464			29/32	3 3/4	1/4
-	ALS11	4/0	4/0	-	0.563	0.522			1 3/4	5 3/4	1/4
ALS12	-	4/0	4/0	-	0.563	0.522			29/32	3 3/4	1/4
-	ALS13	3/0, 4/0	3/0, 4/0, 250 kcmil	250, 300 kcmil	0.575	0.464	-	B80EA	1 3/4	4 5/8	3/8
ALS14	-	3/0, 4/0	3/0, 4/0, 250 kcmil	250, 300 kcmil	0.575	0.464		EEL 13A	1 3/4	6	3/8
-	ALS15	266 ²⁶ / ₇ , 6/7, 18 1/2 kcmil	250-300	350	0.633	0.574		655	1 3/4	6	3/8
ALS16	-	266 ²⁶ / ₇ , 6/7, 18 1/2 kcmil	250-300	350	0.633	0.574		321	1 3/4	4 5/8	3/8
-	ALS17	266 ²⁶ / ₇ , 6/7, 18 1/2, 336 ¹⁸ / ₄	300-350	350-400	0.684	0.609		96H	1 3/4	6	3/8
ALS18	-	266 ²⁶ / ₇ , 6/7, 18 1/2, 336 ¹⁸ / ₄	300-350	350-400	0.684	0.609		CSA 26	1 3/4	4 5/8	3/8
-	ALS19	336 ³⁰ / ₇ , 26/7, 18 1/2, 397 ¹⁸ / ₄	336-400	450-500	0.743	0.666			1 3/4	6	3/8
ALS20	-	336 ³⁰ / ₇ , 26/7, 18 1/2, 397 ¹⁸ / ₄	336-400	450-500	0.743	0.666			1 3/4	4 5/8	3/8
-	ALS23	397 ³⁰ / ₇ , 26/7, 18 1/2, 477 ¹⁸ / ₄	450-500	550-600	0.814	0.743	-	B20AH	1 3/8	5 3/16	9/16
ALS24	-	397 ³⁰ / ₇ , 26/7, 18 1/2, 477 ¹⁸ / ₄	450-500	550-600	0.814	0.743		EEL 14A	1 3/8	6 7/8	9/16
ALS28	-	477 ³⁰ / ₇ , 26/7, 24/7, 556 ¹⁸ / ₄	550-556	650-700	0.883	0.846		318	1 3/8	6 7/8	9/16
ALS32	-	556 ²⁶ / ₇ , 26/7, 636 ¹⁸ / ₄	600-636	750	0.940	0.891		15/16	1 3/8	6 7/8	9/16
ALS44	-	636 ²⁶ / ₇ , 715 ⁵⁴ / ₇ , 666 ²⁶ / ₇ , 54/7	750-800	900	1.031	0.990		CSA 28	1 3/8	6 7/8	5/8
ALS60*	-	900 ⁵⁴ / ₇ , 954 ⁴⁸ / ₇	1,000-1,033	1033	1.172	1.151		106H	1 3/8	6 7/8	5/8
								1 1/2	1 3/8	7 1/4	5/8
								6024	1 3/8	7 1/4	5/8
								125H	1 3/8	7 1/4	5/8
								CSA 30	1 3/8	7 1/4	5/8

Diagrams

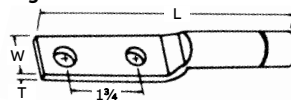

Fig. 1

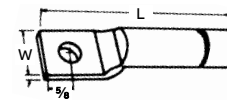

Fig. 2

* For aluminum conductor only

Color-coded compression connectors

Type C – Compression connectors covers



- Hinged polyethylene cover
- Installs easily, quickly – less expensive than taping
- Positive snap-locks fasten securely
- Drain ports prevent accumulation of corrosion-causing moisture
- Ultra-violet stabilized

Type C – Compression connectors covers

Cat. no.	Capacity*	Dimensions (in.)		
		Height	Length	Width
C2BB	All $\frac{5}{8}$ in. and O.D. Die taps, 2 in. long or less	1.10	4.00	1.05
C5C	All "O" Die taps, $1\frac{3}{4}$ in. long or less	1.60	3.75	1.25
C7C	All "D" Die taps, $2\frac{1}{2}$ in. long or less	1.80	5.00	1.45
C9	All "N" and "D" Die taps, up to 2 in. long	2.75	4.25	2.00
C9L	All "N" and "D" Die taps, up to 5 in. long	2.75	7.25	2.00

* Before compression.

Color-coded compression connectors

Type CTL – Copper lugs, one-hole mount, short barrel



Copper compression connectors

- For use with copper conductors: AWG stranded, flexible cable, welding cable and portable cord
- Specially designed for industrial and building applications
- Made of high-conductivity seamless copper tubing
- Tin-plated for corrosion resistance
- Specially chamfered barrel for ease of installation
- Color-coded for matching die identification

- Can be used for medium voltage application up to 35 kV, provided proper insulation techniques are used
- Comply with Subpart 111.60-17 of Federal Register's Coast Guard Electrical Engineering Rules and Regulations

Short barrel connectors

- Short barrel connectors designed for regular-duty applications
- Ideal for confined areas

Type CTL – Copper lugs, one-hole mount, short barrel



Cat. no.	Conductor size (Cu)	Stud size (in.)	Dimensions (in.)						Color code
			A	B	C	L	W	T	
CTL8-10	8 str.	10	13/32	1/2	7/32	1 3/32	3/8	1/16	Red
CTL8-14	8 str.	1/4	13/32	19/32	1/4	1 3/16	7/16	1/16	
CTL8-516	8 str.	5/16	13/32	5/8	9/32	1 5/16	9/16	1/16	
CTL6-10	6 str.	10	7/16	17/32	7/32	1 7/32	7/16	1/16	Blue
CTL6-14	6 str.	1/4	7/16	17/32	7/32	1 7/32	7/16	1/16	
CTL6-516	6 str.	5/16	7/16	21/32	9/32	1 13/32	19/32	1/16	
CTL6-38	6 str.	3/8	7/16	21/32	9/32	1 13/32	19/32	1/16	Gray
CTL4-10	4 str.	10	1/2	19/32	1/4	1 3/8	17/32	3/32	
CTL4-14	4 str.	1/4	1/2	19/32	1/4	1 3/8	17/32	3/32	
CTL4-516	4 str.	5/16	1/2	21/32	5/16	1 13/32	19/32	1/16	
CTL4-38	4 str.	3/8	1/2	21/32	5/16	1 13/32	19/32	1/16	Brown
CTL2-14	2 + 3 str.	1/4	19/32	21/32	1/4	1 1/2	9/16	3/32	
CTL2-516	2 + 3 str.	5/16	19/32	7/8	3/8	1 23/32	9/16	3/32	
CTL2-38	2 + 3 str.	3/8	19/32	29/32	3/8	1 3/4	9/16	3/32	
CTL2-12	2 + 3 str.	1/2	19/32	1 1/16	1/2	1 29/32	3/4	1/16	Green
CTL114	1 str.	1/4	19/32	21/32	1/4	1 1/2	21/32	3/32	
CTL1516	1 str.	5/16	19/32	7/8	3/8	1 23/32	21/32	3/32	
CTL138	1 str.	3/8	19/32	29/32	3/32	1 3/4	21/32	3/32	
CTL112	1 str.	1/2	19/32	1 1/4	1/2	2 3/32	3/4	3/32	Pink
CTL10-516	1/0 str.	5/16	11/16	7/8	3/8	1 13/16	3/4	1/8	
CTL10-38	1/0 str.	3/8	11/16	29/32	3/8	1 7/8	3/4	1/8	
CTL10-12	1/0 str.	1/2	11/16	1 1/4	1/2	2 3/16	3/4	1/8	Black
CTL20-38	2/0 str.	3/8	13/16	29/32	3/8	2 1/32	13/16	1/8	
CTL20-12	2/0 str.	1/2	13/16	1 1/4	1/2	2 11/32	13/16	1/8	
CTL30-38	3/0 str.	3/8	13/16	29/32	3/8	2 1/32	29/32	1/8	Orange
CTL30-12	3/0 str.	1/2	13/16	1 1/4	1/2	2 11/32	29/32	1/8	

See the Color-Keyed tools, dies and kits catalogue for more tool and die information.

Blackburn and ABB are registered trademarks of ABB Installation Products, Ltd. All other trademarks are the property of their respective owners.



Cat. no.	Conductor size (Cu)	Stud size (in.)	Dimensions (in.)						Color code
			A	B	C	L	W	T	
CTL40-38	4/0 str. or 3/0 weld	3/8	15/16	29/32	3/8	2 5/32	1 3/32	1/8	Purple
CTL40-12	4/0 str. or 3/0 weld	1/2	15/16	1 1/4	1/2	2 1/2	1 1/32	1/8	
CTL250-12	250 kcmil or 4/0 weld	1/2	1 1/32	1 1/4	1/2	2 19/32	1 1/8	1/8	Yellow
CTL300-12	300 kcmil	1/2	1 1/32	1 1/4	1/2	2 25/32	1 3/16	5/32	White
CTL350-12	350 kcmil	1/2	1 1/32	1 1/4	1/2	2 25/32	1 11/32	5/32	Red
CTL400-12	400 kcmil	1/2	1 1/32	1 1/4	1/2	3 3/16	1 13/32	5/32	Blue
CTL400-58	400 kcmil	5/8	1 1/32	1 9/16	5/8	3 1/2	1 13/32	5/32	Brown
CTL500-12	500 kcmil	1/2	1 1/32	1 1/4	1/2	3 1/4	1 19/32	7/32	
CTL500-58	500 kcmil	5/8	1 1/32	1 9/16	5/8	3 9/16	1 19/32	7/32	
CTL600-58	600 kcmil	5/8	1 9/16	1 9/16	5/8	3 23/32	1 3/4	7/32	Green
CTL750-58	750 kcmil	5/8	1 1/2	1 9/16	5/8	3 25/32	1 29/32	1/4	Black
CTL1000-58	1,000 kcmil	5/8	1 3/4	1 9/16	5/8	4 1/32	2 1/4	9/32	-

Diagrams

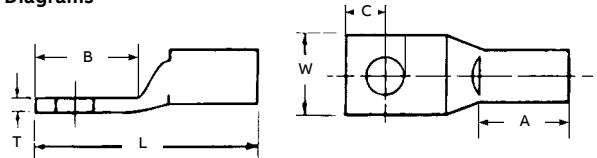

Color-coded compression connectors

Type CTL – Copper lugs, two-hole mount, short barrel



Copper compression connectors

- For use with copper conductors: AWG stranded, flexible cable, welding cable and portable cord
- Specially designed for industrial and building applications
- Made of high-conductivity seamless copper tubing
- Tin-plated for corrosion resistance
- Specially chamfered barrel for ease of installation
- Color-coded for matching die identification
- Can be used for medium voltage application up to 35 kV, provided proper insulation techniques are used

- CSA certified and UL listed for AWG conductors when installed with Blackburn, Burndy, ABB or Anderson tools, as specified by CSA
- Comply with Subpart 111.60-17 of Federal Register’s Coast Guard Electrical Engineering Rules and Regulations

Short barrel connectors

- Short barrel connectors designed for regular-duty applications
- Ideal for confined areas

Type CTL – Copper lugs, two-hole mount, short barrel



Cat. no.	Conductor size (Cu)	Stud size (in.)	Dimensions (in.)							Color code
			A	B	C	D	L	W	T	
CTL6-214	6 str.	1/4	1/2	1 1/4	1/4	5/8	1 31/32	13/32	1/16	Blue
CTL4-214	4 str.	1/4	1/2	1 1/4	1/4	5/8	2 1/32	1/2	3/32	Gray
CTL2-2516	2 + 3 str.	5/16	19/32	1 5/8	3/8	3/4	2 15/32	9/16	3/32	Brown
CTL1-2516	1 str.	5/16	19/32	1 3/4	3/8	7/8	2 19/32	21/32	3/32	Green
CTL10-2516	1/0 str.	5/16	11/16	1 3/4	3/8	7/8	2 11/16	3/4	1/8	Pink
CTL202	2/0 str.	1/2	13/16	2 13/16	1/2	1 3/4	3 13/16	13/16	1/8	Black
CTL302	3/0 str.	1/2	25/32	2 13/16	1/2	1 3/4	3 15/16	15/16	1/8	Orange
CTL402	4/0 str.	1/2	15/16	3	1/2	1 3/4	4 1/4	1 3/32	1/8	Purple
CTL2502	250 kcmil	1/2	1 1/32	3	1/2	1 3/4	4 11/32	1 1/8	5/32	Yellow
CTL3002	300 kcmil	1/2	1 1/32	3	1/2	1 3/4	4 17/32	1 3/16	5/32	White
CTL3502	350 kcmil	1/2	1 1/32	3	1/2	1 3/4	4 17/32	1 11/32	5/32	Red
CTL4002	400 kcmil	1/2	1 11/32	3	1/2	1 3/4	4 15/16	1 13/32	5/32	Blue
CTL5002	500 kcmil	1/2	1 3/8	3	1/2	1 3/4	5	1 17/32	7/32	Brown
CTL6002-38	600 kcmil	3/8	1 17/32	1 29/32	3/8	1 3/4	5 1/8	1 23/32	7/32	Green
CTL6002-12	600 kcmil	1/2	1 17/32	3	1/2	1 3/4	5 1/8	1 23/32	7/32	Green
CTL7502	750 kcmil	1/2	1 1/2	3	1/2	1 3/4	5 7/32	1 29/32	1/4	Black
CTL10002	1,000 kcmil	1/2	1 3/4	3	1/2	1 3/4	5 7/16	2 1/4	9/32	-

Diagrams

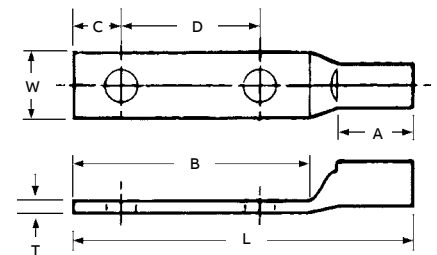

See the Color-Keyed tools, dies and kits catalogue for more tool and die information.

Blackburn and ABB are registered trademarks of ABB Installation Products, Ltd. All other trademarks are the property of their respective owners.

Color-coded compression connectors

Type CTL – Copper lugs, one-hole mount, long barrel



Copper compression connectors

- For use with copper conductors: AWG stranded, flexible cable, welding cable and portable cord
- Specially designed for industrial and building applications
- Made of high-conductivity seamless copper tubing
- Tin-plated for corrosion resistance
- Specially chamfered barrel for ease of installation
- Color-coded for matching die identification
- Can be used for medium voltage application up to 35 kV, provided proper insulation techniques are used

- CSA certified and UL listed for AWG conductors when installed with Blackburn, Burndy, ABB or Anderson tools, as specified by CSA
- Comply with Subpart 111.60-17 of Federal Register's Coast Guard Electrical Engineering Rules and Regulations

Long barrel connectors

- Ideal for industrial, oil rig, mining, welding and transportation electrical termination applications
- Heavy-duty design which permits additional crimp for added mechanical strength

Type CTL – Copper lugs, one-hole mount, long barrel



Cat. no.	Conductor size (Cu)	Flexible conductor size	Stranded	Stud size (in.)	Dimensions (in.)						Color code
					A	B	C	L	W	T	
CTL8L-14	8 str.	¼	37/24	¼	25/32	5/8	¼	1-5/8	13/32	1/16	Red
CTL6L-14	6 str.	¼	61/24	¼	25/32	5/8	¼	1-5/8	13/32	1/16	Blue
CTL4L-14	4 str.	5/16	91/24	¼	25/32	5/8	¼	1 11/16	½	3/32	Gray
CTL2L-516	2 + 3 str.	5/16	125/24	5/16	7/8	7/8	3/8	2 1/2	9/16	3/32	Brown
CTL1L-516	1 str.	5/16	150/24	5/16	1 3/32	7/8	3/8	2 5/32	21/32	3/32	Green
CTL10L-516	1/0 str.	½	225/24	5/16	1 3/32	7/8	3/8	2 7/32	¾	1/8	Pink
CTL20L-38	2/0 str.	½	275/24	3/8	1 3/32	29/32	3/8	2 ¼	13/16	1/8	Black
CTL30L-12	3/0 str.	½	325/24	½	1 1/8	1 ¼	½	2 11/16	29/32	1/8	Orange
CTL40L-12	4/0 str.	½	–	½	1 3/8	1 ¼	½	2 15/16	1 1/32	1/8	Purple
CTL250L-12	250 kcmil	½	450/24	½	1 19/32	1 ¼	½	3 3/8	1 1/8	1/8	Yellow
CTL300L-12	300 kcmil	½	550/24	½	1 25/32	1 ¼	½	3 17/32	1 3/16	1/8	White
CTL350L-12	350 kcmil	½	650/24	½	1 27/32	1 ¼	5/8	3 19/32	1 11/32	5/32	Red
CTL400L-58	400 kcmil	5/8	775/24	5/8	1 27/32	1 9/16	5/8	4 1/32	1 13/32	5/32	Blue
CTL500L-58	500 kcmil	5/8	925/24	5/8	2 11/32	1 9/16	5/8	4 1/2	1 19/32	3/16	Brown
CTL600L-58	600 kcmil	5/8	1,100/24	5/8	2 1/8	1 9/16	5/8	4 5/16	1 23/32	7/32	Green
CTL750L-58	750 kcmil	5/8	1,325/24	5/8	2 3/8	1 9/16	5/8	4 21/32	1 29/32	¼	Black
CTL1000L-58	1,000 kcmil	5/8	1,600/24 1,925/24	5/8	2 7/8	1 9/16	5/8	5 3/32	2 ¼	3/32	–

Diagrams

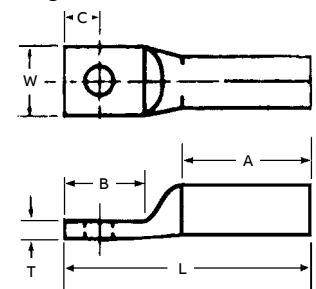

See the Color-Keyed tools, dies and kits catalogue for more tool and die information.

Blackburn and ABB are registered trademarks of ABB Installation Products, Ltd. All other trademarks are the property of their respective owners.

Color-coded compression connectors

Type LCN – Copper lugs, two-hole mount, long barrel



Copper compression connectors

- For use with copper conductors: AWG stranded, flexible cable, welding cable and portable cord
- Specially designed for industrial and building applications
- Made of high-conductivity seamless copper tubing
- Tin-plated for corrosion resistance
- Specially chamfered barrel for ease of installation
- Color-coded for matching die identification
- Can be used for medium voltage application up to 35 kV, provided proper insulation techniques are used

- CSA certified and UL listed for AWG conductors when installed with Blackburn, Burndy, ABB or Anderson tools, as specified by CSA
- Comply with Subpart 111.60-17 of Federal Register's Coast Guard Electrical Engineering Rules and Regulations

Long barrel connectors

- Ideal for industrial, oil rig, mining, welding and transportation electrical termination applications
- Heavy-duty design which permits additional crimp for added mechanical strength

Type LCN – Copper lugs, two-hole mount, long barrel



Cat. no.	Conductor size (Cu)	Flexible conductor size	Stranded	Stud size (in.)	Dimensions (in.)							Color code
					A	B	C	D	L	W	T	
LCN8-14	8 str.	8	37/24	1/4	25/32	13/16	1/4	5/8	2 1/8	15/32	1/16	Red
LCN6-14	6 str.	6	61/24	1/4	25/32	1 1/4	1/4	5/8	1 1/4	13/32	1/16	Blue
LCN6-12	6 str.	6	61/24	1/2	25/32	3	1/2	1 3/4	4 3/32	7/8	3/32	Blue
LCN4-14	4 str.	5	91/24	1/4	25/32	1 3/16	1/4	5/8	2 3/16	17/32	3/16	Gray
LCN4-12	4 str.	5	91/24	1/2	25/32	3	1/2	1 3/4	4 3/32	7/8	3/32	Gray
LCN2-516	2 + 3 str.	3	125/24	5/16	7/8	1 5/8	3/8	3/4	2 15/16	9/16	3/32	Brown
LCN2-12	2 str.	3	125/24	1/2	7/8	3	1/2	1 3/4	4 1/4	7/8	3/32	Brown
LCN1-516	1 str.	2	150/24	5/16	1 1/32	1 5/8	3/8	7/8	2 31/32	21/32	3/32	Green
LCN1-12	1 str.	2	150/24	1/2	1 1/32	3	1/2	1 3/4	4 13/32	7/8	3/32	Green
LCN10	1/0 str.	1	225/24	1/2	1 1/32	3	1/2	1 3/4	3 31/32	3/4	1/8	Pink
LCN20	2/0 str.	1/0	275/24	1/2	1 5/16	3	1/2	1 3/4	4 3/16	13/16	1/8	Black
LCN30	3/0 str.	2/0	325/24	1/2	1 1/8	2 15/16	1/2	1 3/4	4 7/16	15/16	1/8	Orange
LCN40	4/0 str.	–	–	1/2	1 3/8	3	1/2	1 3/4	4 11/16	1 1/32	1/8	Purple
LCN250	250 kcmil	3/0	450/24	1/2	1 19/32	3	1/2	1 3/4	4 29/32	1 1/16	1/8	Yellow
LCN300	300 kcmil	4/0	550/24	1/2	1 25/32	3	1/2	1 3/4	5 9/32	1 3/16	1/8	White
LCN350	350 kcmil	263	650/24	1/2	1 27/32	3	1/2	1 3/4	5 11/32	1 11/32	5/32	Red
LCN400	400 kcmil	313	775/24	1/2	1 27/32	3	1/2	1 3/4	5 7/16	1 13/32	5/32	Blue
LCN500	500 kcmil	373	925/24	1/2	2 11/32	3	1/2	1 3/4	5 15/16	1 19/32	3/16	Brown
LCN600	600 kcmil	444	1,100/24	1/2	2 1/8	3	1/2	1 3/4	5 3/4	1 23/32	7/32	Green
LCN75	750 kcmil	535	1,325/24	1/2	2 3/8	3	1/2	1 3/4	6 3/32	1 29/32	1/4	Black
LCN99	1,000 kcmil	646 777	1,600/24 1,925/24	1/2	2 7/8	3	1/2	1 3/4	6 19/32	2 - 1/4	9/32	–

See the Color-Keyed tools, dies and kits catalogue for more tool and die information.

Blackburn and ABB are registered trademarks of ABB Installation Products, Ltd.
All other trademarks are the property of their respective owners.

Color-coded compression connectors

Type CSP – Copper splices, short barrel



Copper compression connectors

- For use with copper conductors: AWG stranded, flexible cable, welding cable and portable cord
- Specially designed for industrial and building applications
- Made of high-conductivity seamless copper tubing
- Tin-plated for corrosion resistance
- Specially chamfered barrel for ease of installation
- Color-coded for matching die identification
- Can be used for medium voltage application up to 35 kV, provided proper insulation techniques are used

- CSA certified and UL listed for AWG conductors when installed with Blackburn, Burndy, ABB or Anderson tools, as specified by CSA
- Comply with Subpart 111.60-17 of Federal Register’s Coast Guard Electrical Engineering Rules and Regulations

Short barrel connectors

- Short barrel connectors designed for regular-duty applications
- Ideal for confined areas

Type CSP – Copper splices, short barrel



Cat. no.	Conductor size (Cu)	Length (in.)	Color code
CSP8	8 str.	1	Red
CSP6	6 str.	1	Blue
CSP4	4 str.	1	Gray
CSP2	2 + 3 str.	1¼	Brown
CSP1	1 str.	1½	Green
CSP10	1/0 str.	1⅝	Pink
CSP20	2/0 str.	1¾	Black
CSP30	3/0 str.	1¾	Orange
CSP40	4/0 str.	1⅞	Purple
CSP250	250 kcmil	2¼	Yellow
CSP300	300 kcmil	1⅞	White
CSP350	350 kcmil	2¼	Red
CSP400	400 kcmil	2¾	Blue
CSP500	500 kcmil	2¾	Brown
CSP600	600 kcmil	3	Green
CSP750	750 kcmil	3	Black
CSP1000	1,000 kcmil	3⅝	

See the Color-Keyed tools, dies and kits catalogue for more tool and die information.

Blackburn and ABB are registered trademarks of ABB Installation Products, Ltd.
All other trademarks are the property of their respective owners.

Color-coded compression connectors

Type CU – Copper splices, long barrel



Copper Compression Connectors

- For use with copper conductors: AWG stranded, flexible cable, welding cable and portable cord
- Specially designed for industrial and building applications
- Made of high-conductivity seamless copper tubing
- Tin-plated for corrosion resistance
- Specially chamfered barrel for ease of installation
- Color-coded for matching die identification
- Can be used for medium voltage application up to 35 kV, provided proper insulation techniques are used

- CSA certified and UL listed for AWG conductors when installed with Blackburn, Burndy, ABB or Anderson tools, as specified by CSA
- Comply with Subpart 111.60-17 of Federal Register's Coast Guard Electrical Engineering Rules and Regulations

Long Barrel Connectors

- Ideal for industrial, oil rig, mining, welding and transportation electrical termination applications
- Heavy-duty design which permits additional crimp for added mechanical strength

Type CU – Copper splices, long barrel



Cat. no.	Conductor size (Cu)	Flexible conductor		Stud size (in.)	Length (in.)	Color code
		CMA	Stranded			
CU8	8 str.	8	37/24	¼	1¾	Red
CU6	6 str.	6	61/24	¼	1¾	Blue
CU4	4 str.	5	91/24	¼	1¾	Gray
CU2	2 + 3 str.	3	125/24	⅜	1⅞	Brown
CU1	1 str.	2	150/24	⅜	2	Green
CU10	1/0 str.	1	225/24	⅜	2	Pink
CU20	2/0 str.	1/2	275/24	¾	2⅞	Black
CU30	3/0 str.	2/0	325/24	½	2¼	Orange
CU40	4/0 str.	–	–	½	2¾	Purple
CU250	250 kcmil	3/0	450/24	½	3⅞	Yellow
CU300	300 kcmil	4/0	550/24	½	3½	White
CU350	350 kcmil	263	650/24	½	3¾	Red
CU400	400 kcmil	313	775/24	⅝	3¾	Blue
CU500	500 kcmil	373	925/24	⅝	4¾	Brown
CU600	600 kcmil	444	1,100/24	⅝	4¼	Green
CU750	750 kcmil	535	1,325/24	⅝	4¾	Black
CU1000	1,000 kcmil	646 777	1,600/24 1,925/24	⅝	5⅞	

Diagrams



See the Color-Keyed tools, dies and kits catalogue for more tool and die information.

Blackburn and ABB are registered trademarks of ABB Installation Products, Ltd.
All other trademarks are the property of their respective owners.

Color-coded compression connectors

Type ATL – Aluminum lugs, one-hole



Aluminum compression connectors

- Specifically designed for use with aluminum conductors (concentric, compressed or compact)
- Also listed for use with copper conductors
- Made of high-conductivity seamless aluminum tubing
- Tin-plated for corrosion resistance
- Chamfered barrels for ease of installation

- Can be used for medium voltage applications up to 35 kV, provided proper insulation techniques are used
- CSA certified and UL listed for AWG conductors when installed with Blackburn, Burndy, ABB or Anderson tools, as specified by CSA
- Color-coded for quick, easy die identification
- Pre-filled with oxide inhibiting compound

Type ATL – Aluminum lugs, one-hole



Cat. no.	Conductor size		Stud size (in.)	Dimensions (in.)				Dimensions (in.)		Color code
	(Al)	(Cu)		A	B	C	L	W	T	
ATL8-10	8 str.	6 AWG	10	1/2	19/32	7/32	1 9/32	13/32	3/32	Blue
ATL8-14	8 str.	6 AWG	1/4	1/2	11/16	11/32	1 3/8	7/16	3/32	Blue
ATL6-10	6 str.	4 AWG	10	25/32	9/16	7/32	1 1/2	15/32	1/8	Gray
ATL6-14	6 str.	4 AWG	1/4	25/32	23/32	15/32	1 21/32	15/32	1/8	Gray
ATL6-38	6 str.	4 AWG	3/8	27/32	29/32	7/16	1 27/32	5/8	3/32	Gray
ATL4-14	4 str.	1 AWG	1/4	27/32	13/16	11/32	1 29/32	5/8	3/16	Green
ATL4-516	4 str.	1 AWG	5/16	27/32	1	7/16	2 1/16	5/8	3/16	Green
ATL4-38	4 str.	1 AWG	3/8	27/32	29/32	7/16	2	5/8	3/16	Green
ATL2-14	2 + 3 str.	1/0 AWG	1/4	27/32	25/32	11/32	1 15/16	23/32	3/16	Pink
ATL2-516	2 + 3 str.	1/0 AWG	5/16	27/32	7/8	7/16	2 11/32	3/4	3/16	Pink
ATL2-38	2 + 3 str.	1/0 AWG	3/5	27/32	29/32	7/16	2 1/16	23/32	3/16	Pink
ATL1-516	1 str.	–	5/16	27/32	7/8	7/16	2 1/2	23/32	3/16	Gold
ATL1-38	1 str.	–	3/8	27/32	29/32	7/16	2 3/8	3/4	3/16	Gold
ATL10-516	1/0 str.	–	5/16	1 5/32	1	7/16	2 17/32	7/8	3/16	Tan
ATL10-38	1/0 str.	–	3/8	1 5/32	1 1/16	7/16	2 19/32	7/8	3/16	Tan
ATL10-12	1/0 str.	–	1/2	1 5/32	1 3/8	11/16	2 15/16	15/16	3/16	Tan
ATL20-38	2/0 str.	–	3/8	1 3/16	1	7/16	2 5/8	31/32	7/32	Olive
ATL20-12	2/0 str.	–	1/2	1 3/16	1 3/8	11/16	3	1 1/32	7/32	Olive
ATL30-38	3/0 str.	–	3/8	1 11/32	1 1/2	7/16	2 13/16	1 1/16	7/32	Ruby
ATL30-12	3/0 str.	–	1/5	1 11/32	1 3/8	11/16	3 3/8	1 1/16	7/32	Ruby
ATL40-38	4/0 str.	300 kcmil	3/8	1 7/8	1 3/2	3/8	3 3/4	1 3/16	1/4	White
ATL40-12	4/0 str.	300 kcmil	1/2	1 7/8	1 1/4	1/2	3 7/8	1 3/16	1/4	White
ATL250-12	250 kcmil	350 kcmil	1/2	2 1/32	1 1/4	1/2	4 1/32	1 9/32	1/4	Red
ATL300-38	300 kcmil	400 kcmil	3/8	2	1 5/16	3/8	4 3/16	1 3/8	9/32	Blue
ATL300-12	300 kcmil	400 kcmil	1/2	2	1 5/16	1/2	4 3/16	1 3/8	9/32	Blue
ATL350-12	350 kcmil	500 kcmil	1/2	2 11/16	1 5/16	1/2	4 7/8	1 1/2	3/16	Brown
ATL400-58	400 kcmil	600 kcmil	5/8	2 11/16	1 1/4	1/2	4 15/16	1 5/8	3/8	Green
ATL500-12	500 kcmil	700 kcmil	1/2	2 11/16	1 1/4	1/2	4 15/16	1 25/32	3/8	Pink
ATL500-58	500 kcmil	700 kcmil	5/8	2 11/16	2	3/4	5 11/16	1 25/32	3/8	Pink
ATL600-12	–	600 kcmil	1/2	2 11/16	2	3/4	5 13/16	1 29/32	11/32	Black
ATL750-12	750 kcmil	900 kcmil	1/2	2 7/8	1 1/4	1/2	5 1/4	2 1/8	3/8	–
ATL750-58	750 kcmil	900 kcmil	5/8	2 7/8	2	3/4	6 1/32	2 1/8	3/8	–

Diagrams

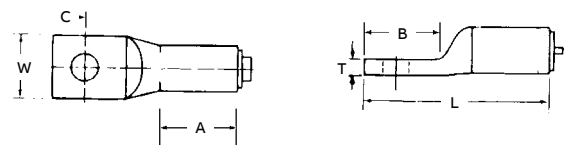

Color-coded compression connectors

Type ATL – Aluminum lugs, two-hole



Aluminum compression connectors

- Specifically designed for use with aluminum conductors (concentric, compressed or compact)
- Also listed for use with copper conductors
- Made of high-conductivity seamless aluminum tubing
- Tin-plated for corrosion resistance
- Chamfered barrels for ease of installation
- Can be used for medium voltage applications up to 35 kV, provided proper insulation techniques are used
- Color-coded for quick, easy die identification
- Pre-filled with oxide inhibiting compound
- CSA certified and UL listed for AWG conductors when installed with Blackburn, Burndy, ABB or Anderson tools, as specified by CSA

Type ATL – Aluminum lugs, two-hole



Cat. no.	Conductor size		Stud size (in.)	Dimensions (in.)							Color code
	(Al)	(Cu)		A	B	C	D	L	W	T	
ATL102-38	1/0 str.	–	3/8	1 5/32	2 1/16	3/8	1	3 19/32	7/8	3/16	Tan
ATL102	1/0 str.	–	1/2	1 3/16	3	1/2	1 3/4	4 9/16	1 5/16	3/16	–
ATL202	2/0 str.	–	1/2	1 3/16	3 3/8	3/4	1 3/4	5	3 1/32	7/32	Olive
ATL302	3/0 str.	–	1/2	1 11/32	3 3/8	3/4	1 3/4	5 5/32	1 1/16	7/32	Ruby
ATL402	4/0 str.	300 kcmil	1/2	1 7/8	3	1/2	1 3/4	5 5/8	1 3/16	1/4	White
ATL2502	250 kcmil	350 kcmil	1/2	2 1/32	3	1/2	1 3/4	5 25/32	1 9/32	1/4	Red
ATL3002	300 kcmil	400 kcmil	1/2	2	3	1/2	1 3/4	5 7/8	1 3/8	9/32	Blue
ATL3502	350 kcmil	500 kcmil	1/2	2 11/16	3	1/2	1 3/4	6 9/16	1 1/2	5/16	Brown
ATL4002	400 kcmil	600 kcmil	1/2	2 11/16	3	1/2	1 3/4	6 11/16	1 5/8	3/8	Green
ATL5002	500 kcmil	700 kcmil	1/2	2 11/16	3	1/2	1 3/4	6 11/16	1 25/32	3/8	Pink
ATL6002	–	600 kcmil	1/2	2 11/16	3	1/2	1 3/4	6 13/16	1 29/32	11/32	Black
ATL7502	750 kcmil	900 kcmil	1/2	2 7/8	3	1/2	1 3/4	7 1/8	2 1/8	3/8	–

Diagrams

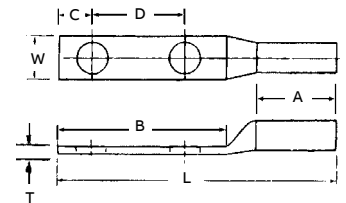

See the Color-Keyed tools, dies and kits catalogue for more tool and die information.

Color-coded compression connectors

Type ASP – Aluminum splices



Aluminum compression connectors

- Specifically designed for use with aluminum conductors (concentric, compressed or compact)
- Also listed for use with copper conductors
- Made of high-conductivity seamless aluminum tubing
- Tin-plated for corrosion resistance
- Chamfered barrels for ease of installation
- Can be used for medium voltage applications up to 35 kV, provided proper insulation techniques are used
- Color-coded for quick, easy die identification
- Pre-filled with oxide inhibiting compound
- CSA certified and UL listed when installed with Blackburn, Burndy, ABB or Anderson tools, as specified by CSA

Type ASP – Aluminum splices



Cat. no.	Conductor size		Length (in.)	Color code
	(Al)	(Cu)		
ASP8	8 str.	6 AWG	1¼	Blue
ASP6	6 str.	4 AWG	1⅝	Gray
ASP4	4 str.	1 AWG	1⅞	Green
ASP2	2 + 3 str.	1/0 AWG	1⅞	Pink
ASP1	1 str.	–	2⅜	Gold
ASP10	1/0 str.	–	2⅜	Tan
ASP20	2/0 str.	–	2½	Olive
ASP30	3/0 str.	–	2⅞	Ruby
ASP40	4/0 str.	300 kcmil	3¾	White
ASP250	250 kcmil	350 kcmil	4	Red
ASP300	300 kcmil	400 kcmil	4	Blue
ASP350	350 kcmil	500 kcmil	3⅞	Brown
ASP400	400 kcmil	600 kcmil	4⅞	Green
ASP500	500 kcmil	700 kcmil	5	Pink
ASP600	–	600 kcmil	5⅝	Black
ASP750	750 kcmil	900 kcmil	5⅝	
ASP1000	1,000 kcmil	–	6	

Diagram

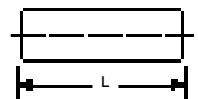

See the Color-Keyed tools, dies and kits catalogue for more tool and die information.

Color-coded compression connectors

Type PA – Pin adapter terminals

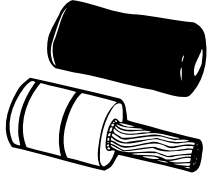

- Connector for aluminum conductors only; pigtail may be inserted into either aluminum or copper connectors
- Insulating cover included
- 90°C rating per UL standard
- Tin-plated stranded copper wire pigtail
- Tin-plated aluminum barrel pre-filled with oxide inhibitor and capped

Type PA – Pin adapter terminals



Cat. no.	Conductor size (Al)	Copper stud size	Dimensions (in.)			Color code	Die #
			A	B	O.D.		
PA06	6 str.	8	$\frac{7}{8}$	$1\frac{11}{32}$	0.640	Orange	50
PA04	4 str.	6	$\frac{7}{8}$	$1\frac{11}{32}$	0.640		50
PA02	2 str.	4	$\frac{7}{8}$	$1\frac{11}{32}$	0.640		50
PA01	1 str.	3	1	$1\frac{11}{32}$	0.640		50
PA11	1/0 str.	2	$1\frac{1}{4}$	$1\frac{19}{32}$	0.906	Red	76
PA21	2/0 str.	1	$1\frac{1}{4}$	$1\frac{19}{32}$	0.906		76
PA31	3/0 str.	1/0	$1\frac{3}{8}$	$1\frac{7}{8}$	0.906		76
PA41	4/0 str.	2/0	$1\frac{3}{8}$	$1\frac{7}{8}$	0.906		76
PA25	250 kcmil	3/0	$1\frac{1}{2}$	$2\frac{1}{16}$	1.155	Brown	87H
PA30	300 kcmil	4/0	$1\frac{5}{8}$	$2\frac{1}{16}$	1.155		87H
PA35	350 kcmil	4/0	$1\frac{5}{8}$	$2\frac{1}{16}$	1.155		87H
PA40	400 kcmil	250 kcmil	$1\frac{7}{8}$	$2\frac{3}{32}$	1.375	Black	106H
PA50	500 kcmil	350 kcmil	$1\frac{7}{8}$	$2\frac{3}{32}$	1.375		106H
PA60	600 kcmil	350 kcmil	$1\frac{7}{8}$	$2\frac{3}{4}$	1.500	Yellow	115H
PA75	750 kcmil	500 kcmil	2	$2\frac{3}{4}$	1.500		115H

Diagram

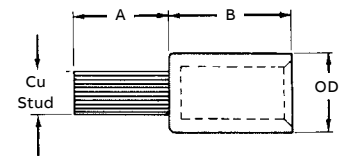

UL listed.
CSA not applicable.

Alum. wire size	Die code	ABB dies							
		UT3	UT5	TBM5	TBM6	TBM8	13642 12-ton	TBM15 UT15	21920 20-ton
#6 – #1	50	5/8	TU	Orange	–	–	–	15529	–
1/0 – 4/0	76 or 76H	–	TX	–	13472 Red 13476 Red	13467	11744	15512	11170
250 kcmil – 350 kcmil	87H	–	TH	–	–	13468	11746	15506	11176
400 kcmil – 500 kcmil	106H	–	–	–	–	–	11749	15515	11140
600 kcmil – 750 kcmil	115H	–	–	–	–	–	11753	15504	11157

Color-coded compression connectors

Type OAPA – Offset pin style and type APA center pin style



Optimum design to allow a reliable termination of aluminum or copper

- Easily transition large aluminum cables into mechanical lugs
- Simplify installations in tight working spaces
- Knurled pins provide a solid contact area to ensure low-resistance connection
- Manufactured from high-conductivity aluminum alloy
- Tin plated to eliminate the possibility of galvanic corrosion
- Pre-filled with oxide inhibitor to ensure airtight termination
- Kitted with an insulating boot to eliminate taping

Material: High-conductivity aluminum alloy

Plating: Electro-tin plated

Insulating boot: EPDM rubber except APA-1000 and OAPA-1000 boot are PVC

Type OAPA – Offset pin style and type APA center pin style



Cat. no. Center pin style	Cat. no. Offset pin style	Wire size	A Overall length (in.)	B Pin length (in.)	C Pin dia. (in.)	D Barrell dia. (in.)	E Boot length (in.)	F Boot dia. (in.)	Die/Color code
APA-6	-	#6 AWG	1.85	0.68	0.24	0.60	3.06	0.81	50/Tan
APA-4	-	#4 AWG	1.85	0.68	0.24	0.60	3.06	0.81	
APA-2	-	#2 AWG	1.85	0.68	0.24	0.60	3.06	0.81	
APA-1	-	#1 AWG	2.01	0.84	0.26	0.60	3.06	0.81	
APA-1/0	-	1/0 AWG	2.21	0.84	0.29	0.85	3.22	1.08	66/White
APA-2/0	OAPA-2/0	2/0 AWG	2.21	0.84	0.33	0.85	3.22	1.08	
APA-3/0	OAPA-3/0	3/0 AWG	2.59	1.22	0.37	0.85	3.22	1.08	
APA-4/0	OAPA-4/0	4/0 AWG	2.59	1.22	0.42	0.85	3.22	1.08	
APA-250	OAPA-250	250 kcmil	2.63	1.22	0.47	1.10	3.50	1.30	87/Brown
APA-300	OAPA-300	300 kcmil	2.75	1.34	0.53	1.10	3.50	1.30	
APA-350	OAPA-350	350 kcmil	2.75	1.34	0.57	1.10	3.50	1.30	
APA-400	OAPA-400	400 kcmil	3.63	1.60	0.68	1.32	3.75	1.47	99/Pink
APA-500	OAPA-500	500 kcmil	3.63	1.60	0.68	1.32	3.75	1.47	
APA-600	OAPA-600	600 kcmil	3.67	1.64	0.73	1.46	4.06	1.72	115/Yellow
APA-750	OAPA-750	750 kcmil	3.79	1.76	0.81	1.46	4.06	1.72	
APA-1000	OAPA-1000	1,000 kcmil	4.03	2.00	0.90	1.70	3.33	2.04	140/-

Diagrams

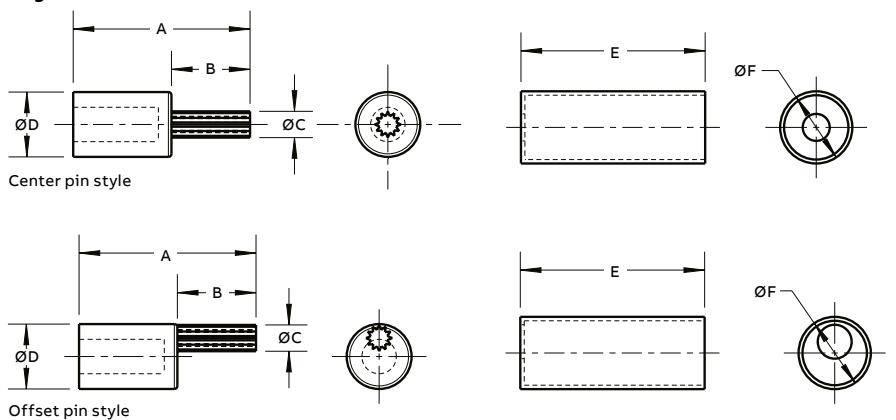

Service wedge clamps

Type W – Stainless steel wedge clamps



- For use on copper neutral
- Stainless steel wedge and slider

Type W – Stainless steel wedge clamps

Cat. no.	Conductor range (AWG or kcmil)			Dimensions (in.)		Typical tensile values	
	ACSR	Al	AAAC	D	L	Conductor	Value (lb)
W62D	2-6	1 str. - 6 sol.	2-6	2 3/8 flex.	12	2.6 x 1 ACSR	1,200

Diagram

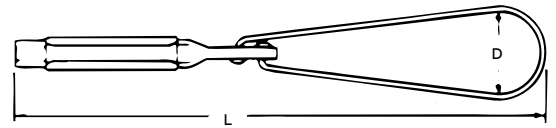

Service wedge clamps

Type W – Aluminum service wedge clamps for use with ACSR, aluminum, AAAC conductors



"FC" flexible bail
(Bail length – 11½ in.)



Rigid stainless steel bail
(Bail length – 6½ in.)

- For dead-ending self-supporting drop wire
- Saves conductor – drop wire may be cut to exact length
- Can be attached to bare neutral at any point in the span
- Adjustments in drop wire sag are easily made
- Grips ACSR, AAAC, or aluminum conductors

Type W – Aluminum service wedge clamps for use with ACSR, aluminum, AAAC conductors

Cat. no.	Description	Conductor range (AWG or kcmil)			Dimensions (in.)		Typical Tensile Values	
		ACSR	Al	AAAC	D	L	Conductor Value (lb)	
W62-1	W-1 Series aluminum wedge and slider	2–6	1 str. – 6 sol.	2–6	2¾ flex.	12, 17½	2 6 x 1 ACSR	1,200
W62-1FC	W-1 Series aluminum wedge and slider	2–6	1 str. – 6 sol.	2–6	2¾ flex.	12, 17½	2 6 x 1 ACSR	1,200
W20-1	W-1 Series aluminum wedge and slider	1/0–4	2/0 str. – 2 sol.	1/0–4	2¾ flex.	12½, 18½	1/0 6 x 1 ACSR	1,800
W20-1FC	W-1 Series aluminum wedge and slider	1/0–4	2/0 str. – 2 sol.	1/0–4	2¾ flex.	12½, 18½	1/0 6 x 1 ACSR	1,800
W40-1*	W-1 Series aluminum wedge and slider	4/0–2/0	4/0 str. – 2 sol.	4/0–2/0	2¾ flex.	12¾, 18½	4/0 6 x 1 ACSR	1,900
W40-1FC*	W-1 Series aluminum wedge and slider	4/0–2/0	4/0 str. – 2 sol.	4/0–2/0	2¾ flex.	12¾, 18½	4/0 6 x 1 ACSR	1,900
W62-1B	W-1B Series for extremely corrosive areas. Iridited aluminum wedge and slider	2–6	1 str. – 6 sol.	2–6	2¾ flex.	12, 17½	2 6 x 1 ACSR	1,200
W62-1BFC	W-1B Series for extremely corrosive areas. Iridited aluminum wedge and slider	2–6	1 str. – 6 sol.	2–6	2¾ flex.	12, 17½	2 6 x 1 ACSR	1,200
W20-1B	W-1B Series for extremely corrosive areas. Iridited aluminum wedge and slider	1/0–4	2/0 str. – 2 sol.	1/0–4	2¾ flex.	12½, 18½	1/0 6 x 1 ACSR	1,800
W20-1BFC	W-1B Series for extremely corrosive areas. Iridited aluminum wedge and slider	1/0–4	2/0 str. – 2 sol.	1/0–4	2¾ flex.	12½, 18½	1/0 6 x 1 ACSR	1,800
W40-1B*	W-1B Series for extremely corrosive areas. Iridited aluminum wedge and slider	4/0–2/0	4/0 str. – 2 sol.	4/0–2/0	2¾ flex.	1-¾, 18½	4/0 6 x 1 ACSR	1,900
W40-1BFC*	W-1B Series for extremely corrosive areas. Iridited aluminum wedge and slider	4/0–2/0	4/0 str. – 2 sol.	4/0–2/0	2¾ flex.	12¾, 18½	4/0 6 x 1 ACSR	1,900

Diagram

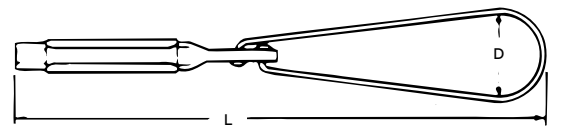

* W40 series clamps rated 850 lb ultimate tension for 1/0 ACSR, AL, or AAAC.

Compression connectors and connector covers

Aluminum H-type

- Prevents oxidation and keeps out moisture
- Easy identification for easy installation
- Approved by the Federal government for utility use
- Comply with ANSI C119.4 when properly installed on aluminum-to-aluminum or aluminum-to-copper conductors

Aluminum H-type

		Standard conductor/ACSR/AAC														
		Main groove, "A" range				Tap groove, "B" range			Side groove, "C" range							
Cat. no.	Style	Groove "A" decimal range	Groove "A" decimal range			Groove "B" decimal range	Groove "B" decimal range			Groove "C" decimal range	Groove "C" decimal range			L (in.)	Die	Tap CVR.
			ACSR	Str.	Sol.		ACSR	Str.	Sol.		Str.	Sol.	Str.			
UB 214	7	0.325-0.162	#2 (7/1)-#6 (6/1)	#2(7)-#6(7)	#1-#6	0.146-0.064	-	#8-#14	#7-#14	-	-	-	¾	5/8 or BG	CO 20, B	
OB 2014	8	0.447-0.292	2/0 (6/1)-#2 (6/1)	2/0(19)-#2(7)	-	0.146-0.064	-	#8-#14	#7-#14	-	-	-	¾	O	CO 20, B	
OB 44	4	0.332-0.162	#2 (7/1)-#6 (6/1)	#1(19)-#6(7)	#2-#6	0.332-0.162	#2 (7/1)-#6 (6/1)	#1(19)-#6(7)	#2-#6	-	-	-	1½	O	CO 20, B	
OB1													1½	O	CO 20, B	
OB 22	6	0.325-0.162	#2 (7/1)-#6 (6/1)	#2(7)-#6(7)	#2-#6	0.325-0.162	#2 (7/1)-#6 (6/1)	#2(7)-#6(7)	#2-#6	0.148-0.062	#8-#14	8-	1½	O	CO 20, B	
OB 101	4	0.419-0.258	1/0 (6/1)-#2 (6/1)	2/0(19)-#2(7)	#2	0.332-0.162	#2 (7/1)-#6 (6/1)	#1(19)-#6(7)	#2-#6	-	-	-	1¾	O	CO 20, B	
OB 2													1¾	O	CO 20, B	
OB 103	1	0.398-0.162	1/0 (6/1)-#6 (6/1)	1/0(19)-#6(7)	#2-#6	0.332-0.162	#2 (7/1)-#6 (6/1)	#1(19)-#6(7)	#2-#6	-	-	-	1½	O	CO 20, B	
OB 1010	1	0.419-0.232	1/0 (6/1)-#4 (6/1)	2/0(19)-#4(7)	#2	0.419-0.232	1/0 (6/1)-#4 (6/1)	2/0(19)-#4(7)	#2	-	-	-	1½	O	CO 20, B	
DB 202	4	0.464-0.354	2/0 (6/1)-#1 (6/1)	3/0(7)-1/0(7)	-	0.332-0.162	#2 (7/1)-#6 (6/1)	#1(19)-#6(7)	#2-#6	-	-	-	1½	D or D3	CD40, B	
DB 3													1½	D or D3	CD40, B	
DB 2020	2	0.464-0.354	2/0 (6/1)-#1 (6/1)	3/0(7)-1/0(7)	-	0.464-0.354	2/0 (6/1)-#1 (6/1)	3/0(7)-1/0(7)	-	-	-	-	1½	D or D3	CD40, B	
DB 404	4	0.563-0.464	4/0 (6/1)-3/0 (6/1)	3/0(7)-4/0(19)	-	0.332-0.162	#2 (7/1)-#6 (6/1)	#1(19)-#6(7)	#2-#6	-	-	-	1¾	D or D3	CD40, B	
DB5													1¾	D or D3	CD40, B	
DB 4020	1	0.563-0.464	4/0 (6/1)-3/0 (6/1)	3/0(7)-4/0(19)	-	0.470-0.316	2/0 (6/1)-#2 (6/1)	3/0(19)-#1(7)	-	-	-	-	1½	D or D3	CD40, B	
DB 6													2½	D or D3	CD40, B	
DB 4040	1	0.563-0.464	4/0 (6/1)-3/0 (6/1)	3/0(7)-4/0(19)	-	0.563-0.464	4/0 (6/1)-3/0 (6/1)	4/0(19)-3/0(7)	-	-	-	-	2¾	D or D3	CD40, B	
DB 7													2½	D or D3	CD40, B	
NB 500	3	0.814-0.522	477 (18/1)-4/0 (6/1)	500(37)-4/0(7)	-	0.814-0.522	477 (18/1)-4/0 (6/1)	500(37)-4/0(7)	-	-	-	-	3¾	N	NC 600, B	
NB 50040	4	0.858-0.528	477 (26/7)-4/0 (6/1)	556.5(37)-4/0(19)	-	0.556-0.368	4/0 (6/1)-1/0 (18/1)	4/0(19)-1/0(7)	3/0-4/0	-	-	-	2	N	NC 600, B	
NB 60020	3	0.915-0.575	556.5 (24/7)-266.8 (18/1)	600(61)-250(37)	-	0.419-0.162	1/0 (6/1)-#6 (6/1)	2/0(19)-#6(7)	2/0-#6	-	-	-	2½	N	NC 600, B	
ZB 954	3	1.196-0.586	954 (54/7)-266.8 (18/1)	1,000(61)-266.8(7)	-	1.196-0.568	954 (54/7)-266.8 (18/1)	1,000(61)-266.8(7)	-	-	-	-	6	Z or R	-	
ZB 95440	5	1.140-0.586	795 (30/19)-266.8 (18/1)	750(61)-266.8(7)	-	0.741-0.522	336.4 (30/7)-4/0 (6/1)	350(37)-4/0(7)	-	0.292-0.162	#2-#6	#2-#6	3	Z or R	-	
ZB 95410	5	1.140-0.586	795 (30/19)-266.8 (18/1)	750(61)-266.8(7)	-	0.563-0.368	4/0 (6/1)-1/0 (6/1)	4/0(19)-1/0(7)	-	0.292-0.162	#2-#6	#2-#6	3	Z or R	-	

Diagrams

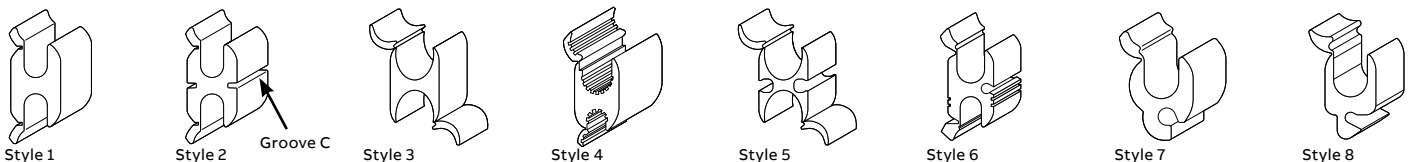

Install with hydraulic tools only. Use UT 5 tool with "O" and "D" connector dies; use UT 15 tool with "O," "D," "N" or "Z" connector dies. For more information, please consult your ABB representative. For Kearney, use "O" and "D" connector dies with mechanical or hydraulic tools. For Burndy, use "O" and "D-3" connector dies with mechanical or hydraulic tools; use "N," "Z" or "R" connector dies with hydraulic tools. Burndy is a registered trademark of Hubbell Incorporated.

Compression connectors and connector covers

Double-locking latches



CO 20 B



CN 600 B

Secure double-locking latches provide a close-fitting top and bottom seal

- Provide a highly reliable end enclosure
- Prevent accumulation of water within the cover, regardless of which half of the cover is down
- Resists the elements, UV sun rays and common contaminants

Double-locking latches

Cat. no.	Height (in.)	Length (in.)	Width (in.)
CO 20 B	2 $\frac{1}{4}$	4 $\frac{1}{2}$	1 $\frac{5}{8}$
CD 40 B	2 $\frac{3}{8}$	5 $\frac{5}{8}$	1 $\frac{3}{4}$
CN 600 B	2 $\frac{15}{16}$	6 $\frac{7}{8}$	2 $\frac{1}{2}$

Aluminum lugs

One-hole CSA die lugs

- Use with aluminum and copper conductors
- Provides high strength and high conductivity
- Prevents oxidation and keeps out moisture
- Easy identification
- Meet or exceed ANSI C119.4 specifications

One-hole CSA die lugs

Cat. no.	Wire size	CSA die	O.D.	I.D.	L	B	P	Dimensions (in.)		
								W	C	T
GLE 2-48	2 str.-Compr-CPT	22	0.635	0.340	3.13	1.37	1.31	0.88	0.63	0.20
GLE 1/0-48	1/0 str.-Compr-CPT	22	0.640	0.420	3.13	1.37	1.31	0.88	0.63	0.21
GLE 2/0-48	2/0 str. Compr-CPT	24	0.840	0.503	3.44	1.37	1.31	1.14	0.63	0.28
GLE 3/0-48	3/0 str.-Compr-CPT	24	0.840	0.547	3.44	1.37	1.31	1.14	0.63	0.28
GLE 4/0-48	4/0 str.-Compr-CPT	24-6T	0.840	0.597	3.44	1.37	1.31	1.14	0.63	0.28
GLE 250-48	250 str.-Compr-CPT	26	1.000	0.620	3.75	1.63	1.31	1.25	0.63	0.36
GLE 300-48	300 str.-Compr-CPT	26-12T	1.000	0.670	3.75	1.63	1.31	1.25	0.63	0.36
GLE 350-48	350 str.-Compr-CPT	28	1.189	0.730	3.75	1.63	1.31	1.25	0.63	0.34
GLE 500-48	500 str.-Compr-CPT	28-12T	1.187	0.836	3.75	1.63	1.31	1.25	0.63	0.36
GLE 500-48-30	500 str.-Compr-CPT	30-12T	1.438	0.880	5.00	2.50	1.50	1.75	0.63	0.52
GLE 750-48	750 str.-Compr-CPT	30	1.438	1.031	5.88	3.00	1.88	1.75	0.88	0.56

Diagrams

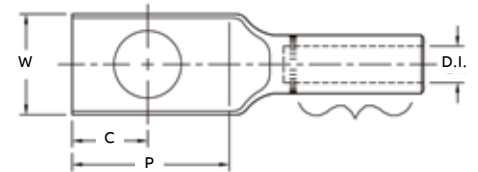

Marking information _____

Cat. no. _____

Wire size _____

Die size _____

of crimps and locations
to be determined
according to connector

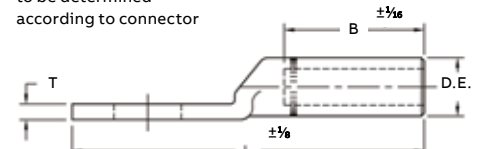

Finish: Tin-plated optional, use suffix "-TN".

Material: E.C. grade aluminum.

Connector bores are coated with HM 53 (an oxide-inhibiting compound) and capped.

Mounting holes sized for $\frac{1}{2}$ " bolts ($\frac{9}{16}$ " hole size).

Optional suffix "-38" for $\frac{3}{8}$ " bolts ($\frac{13}{32}$ " hole size).

Aluminum lugs

Two-hole CSA die lugs

- Use with aluminum and copper conductors
- Provides high strength and high conductivity
- Prevents oxidation and keeps out moisture
- Easy identification
- Meet or exceed ANSI C119.4 specifications

Two-hole CSA die lugs

Cat. no.	Wire size	CSA die	O.D.	I.D.	Dimensions (in.)				
					L	B	P	W	T
GLE 2 N	2 str.–Compr–CPT	22	0.635	0.350	5.29	1.50	3.13	0.88	0.20
GLE 1/0 N	1/0 str.–Compr–CPT	22	0.640	0.420	5.25	1.50	3.13	0.87	0.21
GLE 2/0 N	2/0 str.–Compr–CPT	24	0.840	0.503	5.29	1.50	3.13	1.04	0.28
GLE 3/0 N	3/0 str.–Compr–CPT	24	0.840	0.547	5.38	1.50	3.13	1.14	0.28
GLE 4/0 N	4/0 str.–Compr–CPT	24–6T	0.840	0.594	5.38	1.50	3.13	1.14	0.28
GLE 250 N	250 str.–Compr–CPT	26	1.000	0.620	6.00	2.00	3.13	1.25	0.36
GLE 300 N	300 str.–Compr–CPT	26–12T	1.000	0.670	6.00	2.00	3.13	1.25	0.36
GLE 350 N	350 str.–Compr–CPT	28	1.189	0.730	6.00	2.00	3.13	1.25	0.37
GLE 500 N	500 str.–Compr–CPT	28–12T	1.187	0.836	6.38	2.25	3.13	1.25	0.37
GLE 500 N-30	500 str.–Compr–CPT	30	1.438	0.880	6.38	2.50	3.13	1.75	0.40
GLE 750 N	750 str.–Compr–CPT	30	1.438	1.031	7.50	3.00	3.13	1.75	0.40

Diagrams

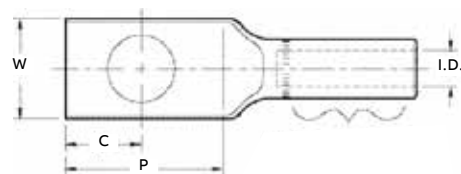

Marking information _____

Cat. no. _____

Wire size _____

Die size _____

of crimps and locations
to be determined
according to connector

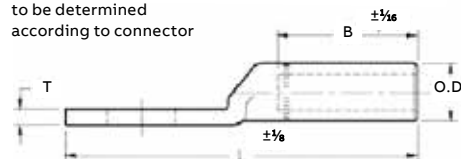

Finish: Tin-plated optional, use suffix “-TN”.

Material: E.C. grade aluminum.

Connector bores are coated with HM 53 (an oxide-inhibiting compound) and capped.

Mounting holes sized for 1/2" bolts (9/16" hole size).

Optional suffix “-38” for 3/8" bolts (13/32" hole size).

Aluminum lugs

One-hole NEMA die lugs



AL 500-48

General-purpose lugs for aluminum and copper terminations

- Use with aluminum and copper conductors
- Provides high strength and high conductivity
- Prevents oxidation and keeps out moisture
- Easy identification
- Meets or exceeds ANSI C119.4 specifications

One-hole NEMA die lugs

Cat. no.	Conductor range (AWG or kcmil)				Bolt size	Installing dies	Dimensions (in.)			
	Concentric	Compressed	Compact	ACSR			B	L	P	W
AL 6-14	#6	-	-	-	¼	TP, 29, 161, ⅝	¾	2 ⁵ / ₃₂	⅞	9 ¹ / ₁₆
AL 4-516	#4				⅝	TB, 37, 375, 162	1 ⁵ / ₁₆	2¼	3 ¹ / ₃₂	⅝
AL 4-14					¼		1 ⁵ / ₁₆	2¼	3 ¹ / ₃₂	⅝
AL 2-14	#2				¼	TQ, 45, 348, 163, ½, 6A	5 ⁹ / ₆₄	2 ⁵ / ₁₆	1 ¹ / ₃₂	¾
AL 2-38					⅜		5 ⁹ / ₆₄	2 ⁵ / ₁₆	1 ¹ / ₃₂	¾
AL 1-38	#1				⅜		5 ⁹ / ₆₄	2 ⁵ / ₁₆	1 ¹ / ₃₂	¾
AL 1/0-38	1/0				⅜	TU, 52, BG, 243, ⅝	1 ³ / ₁₆	3 ³ / ₁₆	1 ⁵ / ₁₆	⅞
AL 1/0-48					½		1 ³ / ₁₆	3 ³ / ₁₆	1 ⁵ / ₁₆	⅞
AL 2/0-38	2/0				⅜	TW-TY, 58, 297, ⅝-1	1 ⁵ / ₁₆	3 ³ / ₁₆	1 ⁷ / ₃₂	1 ⁵ / ₁₆
AL 2/0-48					½		1 ⁵ / ₁₆	3 ³ / ₁₆	1 ⁷ / ₃₂	1 ⁵ / ₁₆
AL 3/0-38	3/0				⅜	737, 467	1 ⁵ / ₁₆	3 ⁷ / ₁₆	1 ⁵ / ₁₆	1 ¹ / ₁₆
AL 3/0-48					½		1 ⁵ / ₁₆	3 ⁷ / ₁₆	1 ⁵ / ₁₆	1 ¹ / ₁₆
AL 4/0-38	4/0				⅜	TX, 71H, 298, 840, 11A	1 ⁷ / ₁₆	3 ³ / ₁₆	1 ¹¹ / ₃₂	1 ³ / ₁₆
AL 4/0-48					½		1 ⁷ / ₁₆	3 ³ / ₁₆	1 ¹¹ / ₃₂	1 ³ / ₁₆
AL 250-48	250, 4/0			4/0	½	TX, 76, 249, 840, 11A	1 ⁷ / ₁₆	3 ⁵ / ₁₆	1 ⁵ / ₁₆	1 ¹⁵ / ₆₄
AL 300-48	300, 266.8		350	266.8 (18/1)	½	TH, 87H, 251, 470, 1, 12A	2 ³ / ₁₆	4	1 ⁵ / ₁₆	1 ³ / ₁₆
AL 350-48	350, 336.4		400	266.8 (26/7), 336.4 (18/1)	½	96, 299, 655, 1 ¹ / ₈ -1, 13A	2 ³ / ₁₆	4¼	1 ⁵ / ₁₆	1½
AL 400-48	400, 397.5		-	336.4 (26/7), 397.5 (18/1)	½		2½	4 ⁷ / ₁₆	1¼	1 ⁵ / ₁₆
AL 400-58					⅝		2½	4 ⁷ / ₁₆	1¼	1 ⁵ / ₁₆
AL 500-48	500, 477		600	379.5 (26/7), 477 (18/1)	½	106A, 300, 317, 1 ¹ / ₁₆ , 14A	3	5 ⁷ / ₁₆	1½	1¾
AL 500-58					⅝		3	5 ⁷ / ₁₆	1½	1¾
AL 600-48	600, 550		-	477 (26/7), 556.5 (18/1)	½	1 ¹ / ₁₆ , 115H, 786, 936, 473	3	5 ²¹ / ₃₂	1 ⁹ / ₁₆	1 ¹⁵ / ₁₆
AL 600-58					⅝		3	5 ²¹ / ₃₂	1 ⁹ / ₁₆	1 ¹⁵ / ₁₆
AL 750-48	750, 700			636 (26/7)	½	140H, 301, 342, 1½	3 ³ / ₁₆	6 ³ / ₁₆	1 ⁷ / ₈	1¾
AL 750-58					⅝		3 ³ / ₁₆	6 ³ / ₁₆	1 ⁷ / ₈	1¾
AL 800-48	800			-	½	1½, 474, 140H	3 ³ / ₁₆	6 ³ / ₁₆	2 ¹ / ₃₂	1¾
AL 800-58					⅝		3 ³ / ₁₆	6 ³ / ₁₆	2 ¹ / ₃₂	1¾
AL 1000-48	1000, 954			795 (26/7), 954 (45/7)	½	161, 292, 302, 319, 1¾	4 ³ / ₁₆	7 ¹⁵ / ₁₆	1 ⁷ / ₈	2 ⁷ / ₁₆
AL 1000-58					⅝		4 ³ / ₁₆	7 ¹⁵ / ₁₆	1 ⁷ / ₈	2 ⁷ / ₁₆

Diagrams

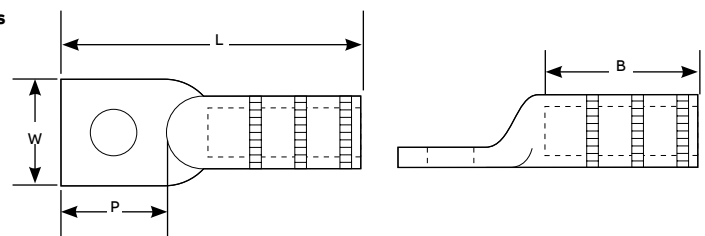

For tin-plated, add "TN" suffix to the catalogue number. All tin-plated lugs are UL listed through 1000 kcmil.
For straight lugs with tapered ends used in high-voltage applications, please consult your ABB representative.

Aluminum lugs

Two-hole NEMA die lugs

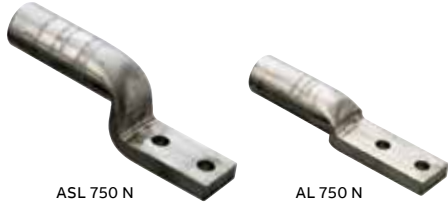

General-purpose lugs for aluminum and copper terminations

- Use with aluminum and copper conductors
- Provides high strength and high conductivity
- Prevents oxidation and keeps out moisture
- Easy identification
- Meets or exceeds ANSI C119.4 specifications

Two-hole NEMA die lugs

Straight lug Cat. no.	Stacking lug Cat. no.	Conductor range (AWG or kcmil)						Dimensions (in.)			
		Concentric	Compr.	Compact	ACSR	Solid	Installing dies	B	L	P	W
SA 6 N	ASL 6 N	#6	#6	#6, #4	#6	4	TU, 52, BG, 243, 5/8, CSA 22	1 ¹⁵ / ₃₂	5 ¹ / ₄	3 ³ / ₁₆	7 ¹ / ₈
SA 4 N	ASL 4 N	#4	#4	-	#4	2		1 ¹⁵ / ₃₂	5 ¹ / ₄	3 ³ / ₁₆	7 ¹ / ₈
SA 2 N	ASL 2 N	#2-#1	#1	#1	#2	1/0		1 ¹ / ₂	5 ³ / ₁₆	3 ¹ / ₄	1
AL 1/0 N	ASL 1/0 N	1/0	-	2/0	1/0	2/0	TU, 52, BG, 243, 5/8	1 ¹ / ₂	5 ¹ / ₄	3 ³ / ₁₆	7 ¹ / ₈
AL 2/0 N	ASL 2/0 N	2/0		-	-	-	TW-TY, 58, 297, 5/8-1	1 ¹ / ₂	5 ¹ / ₄	3 ³ / ₁₆	1 ¹⁵ / ₁₆
AL 3/0 N	ASL 3/0 N	3/0					TV, 66, 167, 467, 10A	1 ⁷ / ₁₆	5 ¹ / ₂	3 ¹ / ₄	1 ¹ / ₁₆
AL 4/0 N	ASL 4/0 N	4/0					TX, 71H, 298, 840, 11A	1 ¹⁵ / ₁₆	6	3 ¹¹ / ₃₂	1 ¹⁵ / ₆₄
AL 250 N	ASL 250 N	250, 4/0		250-300	4/0 (6/1)		TX, 76, 249, 840, 11A	1 ¹⁵ / ₁₆	6	3 ¹¹ / ₃₂	1 ¹⁵ / ₆₄
AL 300 N	ASL 300 N	300, 266.8		350	266.8 (18/1)		TH, 87H, 251, 470, 1, 12A	2 ³ / ₁₆	6 ⁹ / ₁₆	3 ⁹ / ₁₆	1 ¹¹ / ₃₂
AL 350 N	ASL 350 N	350, 336.4		-	266.8 (26/7), 336.4 (18/1)		96, 299, 655, 1 ¹ / ₈ -1, 705, 13A	2 ³ / ₁₆	6 ⁹ / ₁₆	3 ¹¹ / ₁₆	1 ³ / ₄
AL 336 NSC	-	397.5-400			336.4 (26/7), 397.5 (18/1)		1 ¹ / ₄ , 99H, 317, 20AH	4 ³ / ₁₆	9	3 ¹¹ / ₁₆	1 ²¹ / ₃₂
AL 400 N	ASL 400 N	400, 397.5					96, 472, 655, 1 ¹ / ₈ -1, 1 ¹ / ₈ -2, 705, 316, 13A	2 ⁷ / ₁₆	7 ⁹ / ₁₆	3 ⁹ / ₁₆	1 ³ / ₄
AL 500 N	ASL 500 N	500, 477		500-600	397.5 (26/7), 477 (18/1)		106A, 300, 317, 1 ⁵ / ₁₆ , 14A, 15A	2 ¹⁵ / ₁₆	8 ¹ / ₄	3 ⁹ / ₁₆	1 ³ / ₄
AL 500 N 608	-			600			608	3 ¹ / ₈	8- ¹ / ₄	3 ⁹ / ₁₆	1 ³ / ₄
AL 600 N	ASL 600 N	600, 550		-	477 (26/7), 556.5 (18/1)		1 ¹ / ₁₆ , 115H, 786, 936, 473	2 ¹⁵ / ₁₆	7 ³ / ₄	3 ⁵ / ₈	1 ³ / ₄ *
AL 700 N 608	-	700, 600		700-795			125H, 608	3 ³ / ₈	7 ³ / ₈	3 ¹ / ₂	1 ³ / ₄
AL 750 N	ASL 750 N	750, 700		-	636 (26/7)		140H, 301, 342, 1 ¹ / ₂	3 ⁵ / ₁₆	8 ¹ / ₄	3 ³ / ₄	1 ³ / ₄ *
AL 750 N 608	ASL 750 N 608						125H, 608	3 ³ / ₈	8 ¹ / ₄	3 ⁵ / ₈	1 ³ / ₄
AL 800 N	ASL 800 N	800, 795			663 (30/19), 715.5 (54/7)		140H, 474, 342, 724, 1 ¹ / ₂	3 ¹¹ / ₃₂	8 ⁹ / ₁₆	3 ⁵ / ₈	1 ³ / ₄ *
AL 800 N 608	-	800, 700			636 (30/19), 715.5 (54/7)		608	3 ³ / ₈	8 ¹ / ₄	3 ⁵ / ₈	1 ³ / ₄
AL 1000 N	ASL 1000 N	1000, 954			795 (26/7, 30/19), 954 (45/7)		161, 292, 302, 319, 1 ¹ / ₄	4 ¹¹ / ₁₆	8 ⁹ / ₁₆	3 ⁵ / ₈	2 ⁷ / ₁₆
AL 1000 SSN	ASL 1000 SSN	1000				-		4 ¹¹ / ₁₆	9 ⁷ / ₈	1 ⁷ / ₈	2 ⁷ / ₁₆
AL 1000 NMSNP	-							4 ¹¹ / ₁₆	9 ¹ / ₂	3 ⁵ / ₈	1 ³ / ₄
AL 954 NMSNP	-				954 (54/7)			4 ¹¹ / ₁₆	9 ³ / ₈	3 ⁵ / ₈	1 ³ / ₄
AL 1250 N	ASL 1250 N	1200-1300			1113 (45/7), 1192.5 (45/7)		161, 727, 352	4 ¹¹ / ₁₆	9 ¹¹ / ₁₆	3 ⁵ / ₈	2 ²¹ / ₃₂
AL 1750 N	ASL 1750 N	1750				-	214, 735, 225	5 ¹ / ₂	10 ⁷ / ₈	3 ⁷ / ₈	3 ¹³ / ₃₂
AL 2000 N	ASL 2000 N	2000					479	6 ¹ / ₁₆	11 ¹⁵ / ₁₆	3 ⁷ / ₈	3 ¹³ / ₃₂

Diagrams

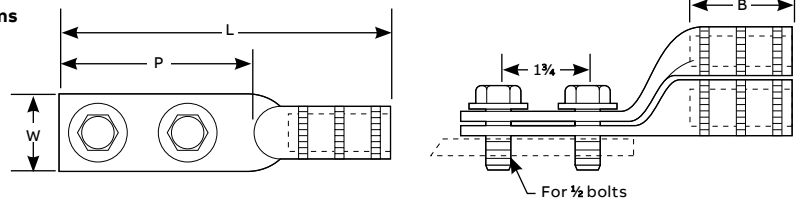

For tin-plated, add "-TN" suffix to the catalogue number. All tin-plated lugs are UL listed through 2000 kcmil. For straight lugs with tapered ends used in high-voltage applications, please consult your ABB representative. Trimmed to 1³/₄" maximum to fit side-by-side on NEMA spades.

Aluminum lugs

Tin-plated two-hole NEMA lugs



General-purpose lugs for aluminum and copper terminations

- Use with aluminum and copper conductors
- Provides high strength and high conductivity
- Prevents oxidation and keeps out moisture
- Easy identification
- Meet or exceed ANSI C119.4 specifications

Tin-plated tapered tees

Straight lug Cat. no.	Stacking lug Cat. no.	Conductor range (AWG or kcmil)					Installing dies	Dimensions (in.)			
		Concentric	Compr.	Compact	ACSR	Solid		B	L	P	W
SA 6 NTN	ASL 6 NTN	#6	#6	#6, #4	#6	#4	TU, 52, BG, 243, 5/8, CSA 22	1 ¹⁵ / ₃₂	5 ³ / ₄	3 ³ / ₁₆	7/8
SA 4 NTN	ASL 4 NTN	#4	#4	-	#4	#2		1 ¹⁵ / ₃₂	5 ³ / ₄	3 ³ / ₁₆	7/8
SA 2 NTN	ASL 2 NTN	#2-#1	#1	#1	#2	1/0		1 ¹ / ₂	5 ³ / ₁₆	3 ³ / ₄	1
AL 1/0 NTN*	ASL 1/0 NTN*	1/0	-	2/0	1/0	2/0	TU, 52, BG, 243, 5/8	1 ¹ / ₂	5 ³ / ₄	3 ³ / ₁₆	7/8
AL 2/0 NTN*	ASL 2/0 NTN*	2/0		-	-	-	TW-TY, 58, 297, 5/8-1	1 ¹ / ₂	5 ³ / ₄	3- ³ / ₁₆	1 ⁵ / ₁₆
AL 3/0 NTN*	ASL 3/0 NTN*	3/0					TV, 66, 167, 467, 10A	1 ⁷ / ₁₆	5 ¹ / ₂	3 ³ / ₄	1 ¹ / ₁₆
AL 4/0 NTN*	ASL 4/0 NTN*	4/0					TX, 71H, 298, 840, 11A	1 ¹⁵ / ₁₆	6	3 ¹¹ / ₃₂	1 ¹⁵ / ₆₄
AL 250 NTN*	ASL 250 NTN*	250, 4/0		250-300		4/0 (6/1)	TX, 76, 249, 840, 11A	1 ¹⁵ / ₁₆	6	3 ¹¹ / ₃₂	1 ¹⁵ / ₆₄
AL 300 NTN*	ASL 300 NTN*	300, 266.8		350		266.8 (18/1)	TH, 87H, 251, 470, 1, 12A	2 ³ / ₁₆	6 ³ / ₁₆	3 ³ / ₁₆	1 ¹¹ / ₃₂
AL 350 NTN*	ASL 350 NTN*	350, 336.4		-		266.8 (26/7), 336.4 (18/1)	96, 299, 655, 1 ¹ / ₈ -1, 705, 13A	2 ³ / ₁₆	6 ³ / ₁₆	3 ¹¹ / ₁₆	1 ³ / ₄
AL 336 NSCTN	-	397.5-400				336.4 (26/7), 397.5 (18/1)	1 ¹ / ₄ , 99H, 317, 20AH	4 ³ / ₁₆	9	3 ¹¹ / ₁₆	1 ²¹ / ₃₂
AL 400 NTN*	ASL 400 NTN*	400, 397.5					96, 472, 655, 1 ¹ / ₈ -1, 1 ¹ / ₈ -2, 705, 316, 13A	2 ⁷ / ₁₆	7 ⁵ / ₁₆	3 ³ / ₁₆	1 ³ / ₄
AL 500 NTN*	ASL 500 NTN*	500, 477		500-600		397.5 (26/7), 477 (18/1)	106A, 300, 317, 1 ¹ / ₈ , 14A, 15A	2 ¹⁵ / ₁₆	8 ³ / ₄	3 ³ / ₁₆	1 ³ / ₄
AL 500 N 608 TN	-			600			608	3 ³ / ₈	8 ³ / ₄	3 ³ / ₁₆	1 ³ / ₄
AL 600 NTN*	ASL 600 NTN*	600, 550		-		477 (26/7), 556.5 (18/1)	1 ¹ / ₈ , 115H, 786, 936, 473	2 ¹⁵ / ₁₆	7 ³ / ₄	3 ³ / ₈	1 ³ / ₄ *
AL 700 N 608TN	-	700, 600		700-795			125H, 608	3 ³ / ₈	7 ³ / ₈	3 ¹ / ₂	1 ³ / ₄
AL 750 NTN*	ASL 750 NTN*	750, 700		-		636 (26/7)	140H, 301, 342, 1 ¹ / ₂	3 ³ / ₁₆	8 ³ / ₄	3 ³ / ₄	1 ³ / ₄ *
AL 750 N 608*	ASL 750 N 608*	750, 700					125H, 608	3 ³ / ₈	8 ³ / ₄	3 ³ / ₈	1 ³ / ₄
AL 800 NTN*	ASL 800 NTN*	800, 795				663 (30/19), 715.5 (54/7)	140H, 474, 342, 724, 1 ¹ / ₂	3 ¹¹ / ₃₂	8 ⁵ / ₁₆	3 ⁵ / ₈	1 ³ / ₄ *
AL 800 N 608 TN	-	800, 700				636 (30/19), 715.5 (54/7)	608	3 ³ / ₈	8 ³ / ₄	3 ⁵ / ₈	1 ³ / ₄
AL 954 NMS	-	-				954 (54/7)	161, 292, 302, 319, 1 ³ / ₄	4 ¹¹ / ₁₆	9 ³ / ₈	1 ⁷ / ₈	1 ³ / ₄
AL 1000 NTN*	ASL 1000 NTN*	1000, 954				795 (26/7, 30/19), 954 (45/7)		4 ³ / ₁₆	8 ³ / ₁₆	3 ⁵ / ₈	2- ⁷ / ₁₆
AL 1000 SSNTN	ASL 1000 SSNTN	1000						4 ³ / ₁₆	9 ⁷ / ₈	3 ⁵ / ₈	2 ⁷ / ₁₆
AL 1000 NMS	-							4 ¹¹ / ₁₆	9 ¹ / ₂	3 ⁵ / ₈	1 ³ / ₄
AL 1250 NTN	ASL 1250 NTN	1200-1300				1113 (45/7), 1192.5 (45/7)	161, 727, 352	4 ¹¹ / ₁₆	9 ¹¹ / ₁₆	3 ⁵ / ₈	2 ²¹ / ₃₂
AL 1750 NTN	ASL 1750 NTN	1750					214, 735, 225	5 ¹ / ₂	10 ⁷ / ₈	3 ⁵ / ₈	3 ¹³ / ₃₂
AL 2000 NTN	ASL 2000 NTN	2000					479	6 ¹ / ₁₆	11 ¹⁵ / ₁₆	3 ⁷ / ₈	3 ¹³ / ₃₂

Diagrams

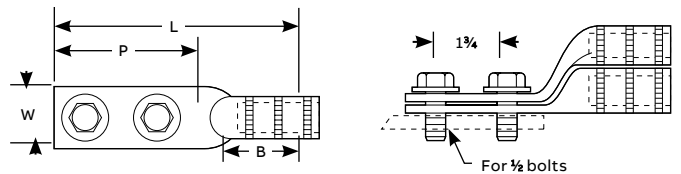

* UL listed.

For two-hole lugs that are not tin-plated, see page 33. For straight lugs with tapered ends used in high-voltage applications, please consult your ABB representative.

Aluminum lugs

Four-hole NEMA lugs



AL 1000-4N

General-purpose lugs for aluminum and copper terminations

- Use with aluminum and copper conductors
- Provides high strength and high conductivity
- Prevents oxidation and keeps out moisture
- Easy identification

Four-hole NEMA lugs

Cat. no.	Conductor range (AWG or kcmil)		Installing dies	Dimensions (in.)					
	Concentric	ACSR		B	N	C	W	P	L
AL 1000-4N	1000	-	161, 302, 292, 319, 1¾	4 ⁹ / ₁₆	1¾	5 ⁵ / ₁₆	3	4	10
AL 14136 X	1033.5-1300	900-1113	161, 727, 352	7 ¹¹ / ₁₆		5 ⁵ / ₁₆	3	4¼	13¾
AL 1033-4N	-	1033.5 (54/7)	34 AH	6 ³ / ₁₆		5 ⁵ / ₁₆	3 ³ / ₈	3 ¹¹ / ₁₆	12¾
AL 1250-4N	1250	-	161, 727, 352	4 ⁵ / ₁₆		5 ⁵ / ₁₆	3	3 ⁹ / ₁₆	10
AL 1272-4N	1272	-	161, 727, 352, 579	6 ⁷ / ₁₆		5 ⁵ / ₁₆	3	3 ⁵ / ₈	11¼
AL 1590-4N	1590	1272 (45/7)	728, 38AH, 189	8 ⁷ / ₁₆		5 ⁵ / ₁₆	3	3 ⁵ / ₈	13½
AL 1750-4N	1750	-	214, 735, 40AH, 225	6 ¹¹ / ₁₆		7 ¹ / ₁₆	3½	3¾	12 ¹ / ₈
AL 2000-4N	1700-2000	1510.5-1590		6 ¹¹ / ₁₆		7 ¹ / ₁₆	3½	3¾	12 ¹ / ₈
AL 2300-4N	2250-2300	2167 (72/7)	44AH	11 ³ / ₄		1 ¹ / ₈	4	4½	18½
AL 2500-4N	2500	2156-2167	214	9 ⁵ / ₈		1 ¹ / ₈	3½	4	15 ³ / ₈

Diagram

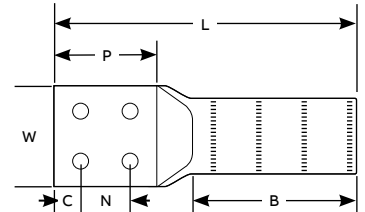

For tin-plated option, add "-TN" suffix to the catalogue number.

Aluminum lugs

One-hole NEMA lugs – Common die series



SA 3/0-48

Designed for general applications and for installation on Homac 125 Series insulated buses

- Lessens your die inventory
- Double terminal capacity of transformer spades and buses to save money
- Use with aluminum and copper conductors
- Provides high strength and high conductivity
- Easy identification
- Meets or exceeds ANSI C119.4 specifications

One-hole NEMA lugs – Common die series

Straight lug Cat. no.	Stacking lug Cat. no.	Conductor – Al or Cu					Installing dies	Dimensions (in.)				
		Concentric	Compressed	Compact	Solid	ACSR		B	H	L	P	W
SA 12-48	-	#12	-	-	#12	-	TU, 52, BG, 243, 5/8, CSA 22	23/32	-	2 9/16	1 1/4	7/8
SA 10-48	-							23/32		2 9/16	1 1/4	7/8
SA 8-48	-	#8			#6			1 7/16		3 1/8	1 5/16	7/8
SA 6-48	-	#6	#6	#4	#4	#6		1 7/16		3 1/8	1 5/16	7/8
SA 4-48	-	#4	#4		#2	#4		1 7/16		3 1/8	1 5/16	7/8
SA 3-48	-	#2	#2	#1, #2	#1	-		1 7/16		3 1/8	1 5/16	7/8
SA 2-48	SASL 2-48	#1, #2	#1	#1	1/0	#2		1 7/16	1 1/2	3 1/8	1 5/16	7/8
SA 386-48	-	#1	1/0	1/0	-	-		1 7/16	-	3 1/8	1 5/16	7/8
SA 1/0-48	SASL 1/0-48	1/0	2/0	2/0		1/0		1 7/16	1 1/2	3 1/8	1 5/16	7/8
SA 2/0-48	SASL 2/0-48	2/0	3/0	3/0	3/0	2/0 (6/1)	TX, 76, 249, 840, 845, 11A, CSA 24	1 25/64	1 3/4	3 21/64	1 11/32	1 5/32
SA 3/0-48	SASL 3/0-48	3/0	4/0	4/0	-	3/0		1 25/64	1 3/4	3 21/64	1 11/32	1 5/32
SA 4/0-48	SASL 4/0-48	4/0, 250	4/0, 250	250, 300		4/0		1 25/64	1 7/8	3 21/64	1 11/32	1 5/32
SA 300-48	-	300	300	350		266.8 (18/1)	96, 299, 655, 321, 316, 13A, 1 (1/8-1), 472, CSA 28	1 19/32	-	3 5/8	1 11/32	1 1/4
SA 350-48	-	336.4-350	350	400		266.8 (26/7), 336.4 (18/1)		1 19/32		3 5/8	1 11/32	1 1/4
SA 400-48	-	336.4-400	400	500		336.4 (18/1), 397.5 (18/1)		1 19/32		3 5/8	1 11/32	1 1/4

Diagrams

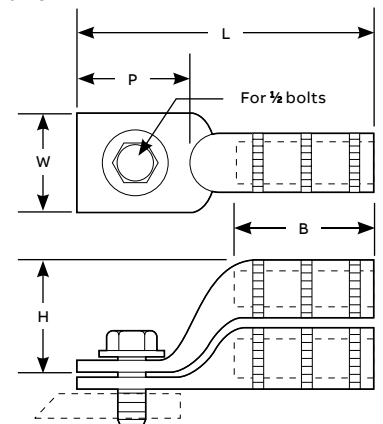

For tin-plated option, add "-TN" suffix to the catalogue number.

To order a stud size not specified with a terminal lug on this page, change the last two digits from "48" (designating a 1/2" stud) to "38" (for a 3/8" stud).

Aluminum lugs

Two-hole NEMA – Common die series



Designed for general applications and for installation on Homac 125-N Series insulated buses

- Lessens your die inventory
- Double terminal capacity of transformer spades and buses to save money
- Use with aluminum and copper conductors
- Provides high strength and high conductivity
- Prevents oxidation and keeps out moisture
- Easy identification
- Meets or exceeds ANSI C119.4 specifications

Two-hole NEMA – Common die series

Straight lug Cat. no.	Stacking lug Cat. no.	Conductor – Al or Cu					Installing dies	Dimensions (in.)				
		Concentric	Compressed	Compact	Solid	ACSR		B	H	L	P	W
SA 8 N	-	#8	-	-	#6	-	TU, 52, BG, 243, 5%, CSA 22	1 ¹⁵ / ₁₆	-	5 ¹ / ₈	3 ³ / ₁₆	7 ¹ / ₈
SA 6 N	SASL 6 N	#6	#6	#4	#4	#6		1 ¹⁵ / ₁₆	1 ¹ / ₂	5 ¹ / ₈	3 ³ / ₁₆	7 ¹ / ₈
SA 4 N	-	#4	#4	#4	#2	#4		1 ¹⁵ / ₁₆	-	5 ¹ / ₈	3 ³ / ₁₆	7 ¹ / ₈
SA 3 N		#2	#2	#1, #2	#1	-		1 ¹⁵ / ₁₆		5 ¹ / ₈	3 ³ / ₁₆	7 ¹ / ₈
SA 2 N		#1, #2	#1	#1	1/0	#2		1 ¹ / ₂		5 ³ / ₁₆	3 ³ / ₁₆	1
SA 386N		#1, 1/0	#1, 1/0	1/0	-	#1		2 ⁷ / ₃₂		5 ¹ / ₂	3	7 ¹ / ₈
AL 1/0 N	SASL 1/0 N	1/0	1/0	2/0	2/0	1/0		1 ¹ / ₂	1 ¹ / ₂	5 ¹ / ₄	3 ³ / ₁₆	7 ¹ / ₈
SA 2/0 N	SASL 2/0 N	2/0	2/0	3/0	3/0	2/0 (6/1)	TX, 76, 249, 840, 845, 11A, CSA 24	1 ¹⁵ / ₁₆	1 ³ / ₄	6	3 ³ / ₁₆	1 ¹ / ₄
SA 3/0 N	SASL 3/0 N	3/0	4/0	4/0	-	3/0		1 ¹⁵ / ₁₆	1 ³ / ₄	6	3 ³ / ₁₆	1 ⁵ / ₃₂
SA 4/0 N	SASL 4/0 N	4/0, 250	4/0, 250	250, 300		4/0		1 ¹⁵ / ₁₆	1 ³ / ₁₆	6	3 ³ / ₁₆	1 ⁷ / ₃₂
SA 300 N	-	300	300	350		266.8 (18/1)	96, 299, 655, 705, 321, 316, 13A, 1 (3/8-1), 472, CSA 28	2 ¹ / ₁₆	-	6 ¹ / ₄	3	1 ¹ / ₄
SA 350 N		336.4-350	350	400		266.8 (26/7), 336.4 (18/1)		2 ³ / ₁₆		6 ¹ / ₄	3	1 ¹ / ₄
SA 400 N		336.4-400	400	500		336.4 (18/1), 397.5 (18/1)		2 ⁷ / ₁₆		6 ³ / ₈	3	1 ¹ / ₄

Diagrams

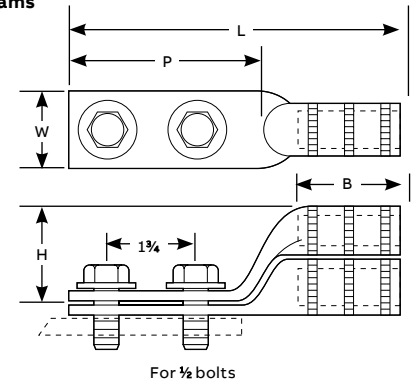

For tin-plated option, add "-TN" suffix to the catalogue number.

Aluminum lugs

Meter socket lugs – 840 Common die series



SAKM 250-48

Just one die installs the entire conductor range for meter pan and general applications

- Lessens your die inventory
- Provides high strength and high conductivity
- Use with aluminum and copper conductors
- Prevents oxidation
- Easy identification
- Meets or exceeds ANSI C119.4 specifications

Meter socket lugs – 840 Common die series

½ bolt Cat. no.	¾ bolt Cat. no.	Conductors – Al or Cu				Installing dies
		Concentric	Compressed	Compact	Solid	
SAKM 6-48	SAKM 6-38	#6	#6	#6	–	840, 845, TX, 76, 249, 11A
SAKM 4-48	SAKM 4-38	#4	#4	#4	–	840, 845, TX, 76, 249, 11A
SAKM 2-48	SAKM 2-38	#2	#2	#2, #1	#1	840, 845, TX, 76, 249, 11A
SAKM1-48	SAKM 1-38	#1	#1	1/0	1/0	840, 845, TX, 76, 249, 11A
SAKM 1/0-48	SAKM 1/0-38	1/0	1/0	2/0	2/0	840, 845, TX, 76, 249, 11A
SAKM 2/0-48	SAKM 2/0-38	2/0	2/0	3/0	3/0	840, 845, TX, 76, 249, 11A
SAKM 3/0-48	SAKM 3/0-38	3/0	3/0	4/0	–	840, 845, TX, 76, 249, 11A
SAKM 4/0-48	SAKM 4/0-38	4/0	4/0	250	–	840, 845, TX, 76, 249, 11A
SAKM 250-48*	SAKM 250-38*	250	250	300	–	840, 845, TX, 76, 249, 11A
SAKM 300-48*	SAKM 300-38*	300	300	350	–	840, 845, TX, 76, 249, 11A
SAKM 350-48*	SAKM 350-38*	350	350	–	–	840, 845, TX, 76, 249, 11A

Diagrams

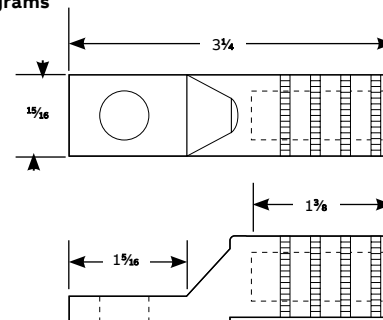

* For aluminum conductors only.
For tin-plated option, add "-TN" suffix to the catalogue number.

Aluminum lugs

Tin-plated meter socket lugs – Star hole



MSL 350

Dual-rated, corrosion-resistant lugs available with star holes

- Provides high strength and high conductivity
- Use with aluminum and copper conductors
- Resistant to corrosion
- Prevents oxidation and keeps out moisture

Tin-plated meter socket lugs – Star hole

Cat. no.	Conductor size	Installing dies	Dimensions (in.)			
			W	L	P	B
MSL 4	#4 str. cpt.	840, 845, TX, 76, 249, 11A	$\frac{15}{16}$	$3\frac{1}{4}$	$1\frac{5}{16}$	$1\frac{3}{8}$
MSL 2	#2 str. cpt.	840, 845, TX, 76, 249, 11A	$\frac{15}{16}$	$3\frac{1}{4}$	$1\frac{5}{16}$	$1\frac{3}{8}$
MSL 1/0	1/0 str. cpt.	840, 845, TX, 76, 249, 11A	$\frac{15}{16}$	$3\frac{1}{4}$	$1\frac{5}{16}$	$1\frac{3}{8}$
MSL 2/0	2/0 str. cpt.	840, 845, TX, 76, 249, 11A	$\frac{15}{16}$	$3\frac{1}{4}$	$1\frac{5}{16}$	$1\frac{3}{8}$
MSL 3/0	3/0 str. cpt.	840, 845, TX, 76, 249, 11A	$\frac{15}{16}$	$3\frac{1}{4}$	$1\frac{5}{16}$	$1\frac{3}{8}$
MSL 4/0	4/0 str. cpt.	840, 845, TX, 76, 249, 11A	$\frac{15}{16}$	$3\frac{1}{4}$	$1\frac{5}{16}$	$1\frac{3}{8}$
MSL 250	250 str. cpt.	840, 845, TX, 76, 249, 11A	$\frac{15}{16}$	$3\frac{1}{4}$	$1\frac{5}{16}$	$1\frac{3}{8}$
MSL 300	300 str. cpt.	840, 845, TX, 76, 249, 11A	$\frac{15}{16}$	$3\frac{1}{4}$	$1\frac{5}{16}$	$1\frac{3}{8}$
MSL 350	350 str. cpt.	840, 845, TX, 76, 249, 11A	$\frac{15}{16}$	$3\frac{1}{4}$	$1\frac{5}{16}$	$1\frac{3}{8}$
MSL 500	500 str.	106A, 300, 317, $1\frac{1}{16}$, 15A	$1\frac{3}{4}$	$4\frac{7}{8}$	$1\frac{3}{4}$	$3\frac{3}{16}$

Diagrams

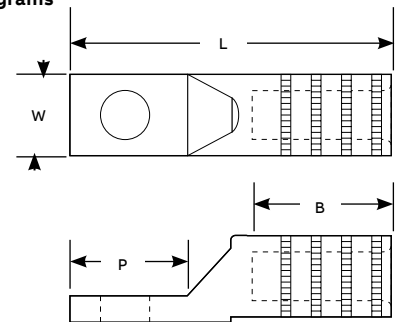

Aluminum lugs

Two-hole NEMA lugs – Common die series



SAB 500 N

Lugs designed for general-purpose substation and switchyard equipment use

- Lessens your die inventory
- Use with aluminum and copper conductors
- Provides high strength and high conductivity
- Prevents oxidation and keeps out moisture
- Easy identification

Two-hole NEMA lugs — Common die series

Cat. no.	Conductor range (AWG or kcmil)				Installing dies	Dimensions (in.)		
	Concentric	Compressed	Compact	ACSR		L	W	B
SAK 4 N	#4	-	-	-	TX, 76, 249, 840, 11A	5 ³ / ₄	1 ¹ / ₄	2
SAK 2 N	#1, #2	-	-	#2	TX, 76, 249, 840, 11A	5 ³ / ₄	1 ¹ / ₄	2
SAK 1/0 N	1/0	2/0	2/0	1/0	TX, 76, 249, 840, 11A	5 ³ / ₄	1 ¹ / ₄	2
SAK 300 N	-	-	350	-	TX, 76, 249, 840, 11A	6 ¹ / ₄	1 ¹ / ₄	2 ¹ / ₁₆
SAK 350 N	350	-	-	-	TX, 76, 249, 840, 11A	6 ¹ / ₄	1 ¹ / ₄	2 ¹ / ₁₆
SAB 3/0 N	3/0	-	-	3/0	96, 299, 655, 1 (1/8-1), 13A	6 ³ / ₈	1 ¹ / ₂	2 ³ / ₄
SAB 4/0 N	4/0, 250	-	-	4/0	96, 299, 655, 1 (1/8-1), 13A	6 ³ / ₈	1 ¹ / ₂	2 ³ / ₄
SAB 250 N	266.8-300	-	-	266.8 (18/1)	96, 299, 655, 1 (1/8-1), 13A	6 ³ / ₈	1 ¹ / ₂	2 ³ / ₄
SAB 500 N	477-500	-	600	397.5 (26/7, 30/7), 477 (18/1)	96, 299, 655, 1 (1/8-1), 13A	6 ³ / ₈	1 ¹ / ₄	2 ³ / ₄
SAM 400 N	397.5-400	-	500	336.4 (30/7), 397.5 (18/1)	106, 300, 317, 1 ¹ / ₁₆ , 14A, 15A	8 ²⁹ / ₆₄	1 ³ / ₄	3 ¹³ / ₁₆
SAM 556 N	500-556	-	-	477 (26/7), 556.5 (18/1)	106, 300, 317, 1 ¹ / ₁₆ , 14A, 15A	8 ³ / ₈	1 ³ / ₄	3 ²⁷ / ₃₂
SAM 600 N	600	-	-	-	106, 300, 317, 1 ¹ / ₁₆ , 14A, 15A	8 ³ / ₈	1 ³ / ₄	3 ²⁷ / ₃₂

Diagrams

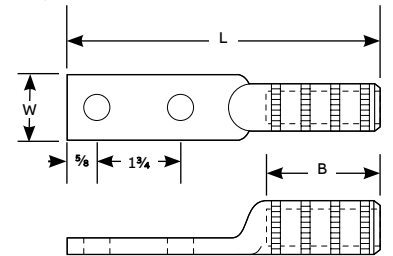

Aluminum lugs

Four-hole NEMA lugs – Common die series



MSL 350

Durable four-hole lugs for general-purpose substation and switchyard equipment use

- Lessens your die inventory
- Use with aluminum and copper conductors
- Provides high strength and high conductivity
- Prevents oxidation and keeps out moisture
- Easy identification

Four-hole NEMA lugs – Common die series

Cat. no.	Conductor range (AWG or kcmil)			Installing dies	Dimensions (in.)	
	Concentric	Compact	ACSR		L	B
SAM 3/0-4N*	3/0	–	–	1 ⁵ / ₁₆ , 300, 14A, 106, 317	8 ¹ / ₈	3 ³ / ₁₆
SAM 4/0-4N*	4/0	–	4/0	1 ⁵ / ₁₆ , 300, 14A, 106, 317	8 ¹ / ₈	3 ³ / ₁₆
SAM 250-4N*	250	–	–	1 ⁵ / ₁₆ , 300, 14A, 106, 317	8 ¹ / ₈	3 ³ / ₁₆
SAM 300-4N*	300	–	–	1 ⁵ / ₁₆ , 300, 14A, 106, 317	7 ⁷ / ₈	3 ²¹ / ₆₄
SAM 350-4N*	336.4-350	–	266.8 (26/7), 336.4 (18/1)	1 ⁵ / ₁₆ , 300, 14A, 106, 317	7 ⁷ / ₈	3 ²¹ / ₆₄
SAM 400-4N*	397.5-400	–	336.4 (30/7), 397.5 (18/1)	1 ⁵ / ₁₆ , 300, 14A, 106, 317	7 ⁷ / ₈	3 ²¹ / ₆₄
SAM 500-4N*	500	–	–	1 ⁵ / ₁₆ , 300, 14A, 106, 317	8 ³ / ₄	3 ³ / ₁₆
SAM 600-4N*	556.5-600	–	–	1 ⁵ / ₁₆ , 300, 14A, 106, 317	8 ³ / ₄	3 ³ / ₁₆
SAL 500-4N*	500	–	477 (18/1)	140H, 301, 342, 1 ¹ / ₂	8 ³ / ₄	3 ³ / ₈
SAL 600-4N	600	–	477 (24/7, 30/7)	140H, 301, 342, 1 ¹ / ₂	7 ⁷ / ₈	3 ³ / ₈
SAL 650-4N	600, 636, 650	–	556.5 (24/7, 26/7)	140H, 301, 342, 1 ¹ / ₂	7 ⁷ / ₈	3 ³ / ₈
SAL 750-4N	700-750	–	636 (26/7)	140H, 301, 342, 1 ¹ / ₂	9	4 ⁷ / ₃₂
SAL 800-4N	700-800	954	636 (26/7)	140H, 301, 342, 1 ¹ / ₂	8 ³ / ₄	4 ³ / ₃₂
SAL 1000-4N	1,000	1,000	795 (30/19), 874 (54/7)	140H, 301, 342, 1 ¹ / ₂	8 ³ / ₄	4 ⁵ / ₃₂
SAL 1033-4N	1,033	–	900 (54/7), 954 (45/7)	140H, 301, 342, 1 ¹ / ₂	9	4 ⁵ / ₃₂

Diagrams

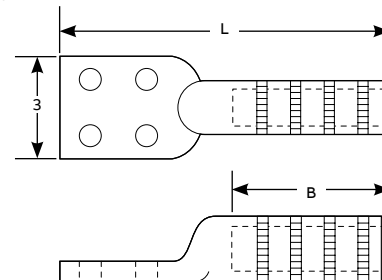

* Designates 2-piece welded design.

Aluminum lugs

Shrouded one-hole lugs – Common die series



RSG 1/0-48



RSK 2-48



Style 2

Style 1

If you need rain protection, these lugs have you covered

- Prevents rainwater from entering cable
- Lessens your die inventory
- Provides high strength and high conductivity
- Use with aluminum and copper conductors
- Prevents oxidation
- Easy identification
- Meets or exceeds ANSI C119.4 specifications

Shrouded one-hole lugs – Common die series

Cat. no.	Conductor size (AWG or kcmil)		Shroud I.D.	Comp. die size	L	Style
	Concentric	Compact				
3/8" Compression die series						
RSG 6-48	#6	–	0.400	3/8, 8A, 243, TU, 52, BG	3 3/8	2
RSG 4-48	#4	#4	0.450	3/8, 8A, 243, TU, 52, BG	3 3/8	2
RSG 2-48	#2, #1	#1	0.635	3/8, 8A, 243, TU, 52, BG	3 3/8	1
RSG 1/0-48	1/0	2/0	0.640	3/8, 8A, 243, TU, 52, BG	3 3/8	1
840 Compression die series						
RSK 1/0-48	1/0	2/0	0.640	840, 11A, 249, 76, TX	3 3/4	2
RSK 2/0-48	2/0	3/0	0.750	840, 11A, 249, 76, TX	3 3/4	2
RSK 3/0-48	3/0	4/0	0.750	840, 11A, 249, 76, TX	3 3/4	2
RSK 4/0-48	4/0	4/0	0.750	840, 11A, 249, 76, TX	3 3/4	2
RSK 250-48	4/0-250	350	0.812	840, 11A, 249, 76, TX	3 3/4	2
RSK 350-48	350	–	0.927	840, 11A, 249, 76, TX	4 7/16	1
1 1/8" Compression die series						
RSB 300-48	300	300	0.927	1 (3/8-1), 12A, 96, 299, 655	4 1/2	2
RSB 350-48	350	300	0.927	1 (3/8-1), 12A, 96, 299, 655	4 1/2	2

Diagram

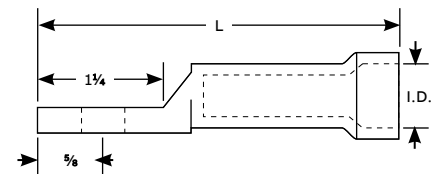

For tin-plated option, add "-TN" suffix to the catalogue number.

To order a terminal lug for a 3/8" stud, change a catalogue number's "-48" suffix (designating a 1/2-in. stud) to a "-38" suffix.

To order with hardware as kits, add "-TMH" suffix to the catalogue number.

Aluminum lugs

Tin-plated one-hole lugs



For application in meter pans and in other metal-enclosed gear to convenience wiring where clearances are minimal

- Assures high strength and high conductivity
- Provides resistance against corrosion
- Use with aluminum and copper conductors
- Prevents oxidation
- Easy identification
- Meets or exceeds ANSI C119.4 specifications

Tin-plated one-hole lugs

Left-hand lug Cat. no.	Right-hand lug Cat. no.	Conductor size (AWG or kcmil)			Installing dies	Dimensions (in.)		
		Concentric	Compressed	Compact		B	L	W
AL 1/0-48 LTN	AL 1/0-48 RTN	1/0	1/0	2/0	5/8, BG, TU	1 3/8	2 11/16	1 3/8
AL 2/0-48 LTN	AL 2/0-48 RTN	2/0	2/0	-	1 1/8, 297, TW-TY	1 3/8	2 11/16	1 3/8
AL 3/0-48 LTN	AL 3/0-48 RTN	3/0	3/0	-	737, 467	1 3/8	3 3/4	1 3/8
AL 4/0-48 LTN	AL 4/0-48 RTN	4/0	4/0	-	840, 298, TX	1 1/2	4	1 3/4
AL 250-48 LTN	AL 250-48 RTN	250	250	300	840, 324, TX	1 5/8	4 1/8	1 3/4
AL 300-48 LTN	AL 300-48 RTN	300	300	350	1, 470, TH	1 5/8	4 3/8	1 1/2
AL 350-48 LTN	AL 350-48 RTN	350	350	350	1 (1/8-1), 299, 96	1 5/8	4 3/8	1 1/2
AL 400-48 LTN	AL 400-48 RTN	400	400	400	1 1/8, 472, 96	2 1/2	5 3/4	1 1/2
AL 500-48 LTN	AL 500-48 RTN	500	500	500	1 1/16, 300, 106A	2 1/2	5 3/4	1 1/2
AL 750-48 LTN	AL 750-48 RTN	700-750	800	800	1 1/2, 301, 140H	3 1/4	6 3/8	3 1/2

Diagram

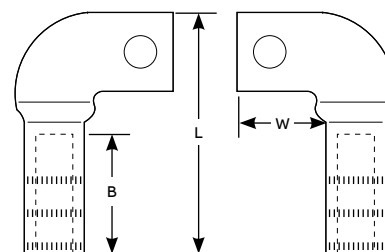

For NEMA-drilled lugs, substitute a "-NLTN" suffix for a "-48 x TN" suffix to the catalogue number. Thus AL 350-48 RTN becomes AL 350-NLTN. NEMA drilling is 2 9/16" holes on 1 3/4" centers.

Aluminum lugs

Multi-range die-less lugs and pin terminals



AL 4/0 NTN

Save yourself a die job with these multi-range lugs

- Assures high strength and high conductivity
- Provides resistance against corrosion
- Use with aluminum and copper conductors
- Prevents oxidation
- Easy identification

Multi-range die-less lugs

Cat. no.	Conductor range (AWG or kcmil) alum. or copper	Tool	Figure	Bolt size	Dimensions (in.)		
					B	L	P
AL 1/0-48 TN	#6 str.-1/0 str.	VC 5/VC 6	1	1/2	1 3/8	3 3/16	1 5/16
AL 1/0 NTN	#6 str.-1/0 str.	VC 5/VC 6	2	1/2	1 3/8	5 1/4	3 1/4
ASL 1/0 NTN	#6 str.-1/0 str.	VC 5/VC 6	3	1/2	1 3/8	5 1/4	3
AL 4/0-48 TN	#2 str.-4/0 str.	VC 5/VC 6	1	1/2	1 7/16	3 3/16	1 3/8
AL 4/0 NTN	#2 str.-4/0 str.	VC 5/VC 6	2	1/2	2	6	3 3/16
ASL 4/0 NTN	#2 str.-4/0 str.	VC 5/VC 6	3	1/2	2	6	3
AL 300-48 TN	1/0 str.-300	VC 6	1	1/2	2 1/4	4	1 5/16
AL 300 NTN	1/0 str.-300	VC 6	2	1/2	2 1/4	6 9/16	3 3/16
AASL 300 NTN	1/0 str.-300	VC 6	3	1/2	2 1/4	6 9/16	3
SAB 500-48 TN	4/0 str.-500	VC 6	1	1/2	2 1/2	4 9/16	1 1/2
SAB 500 NTN	4/0 str.-500	VC 6	2	1/2	2 1/4	6 3/8	3 1/8
AASL 500 NTN	4/0 str.-500	VC 6	3	1/2	2 1/2	6 7/8	2 7/8
AL 750 N 608 TN	4/0 str.-750	VC 8	2	1/2	3 3/4	8 3/4	3 3/8

Diagrams

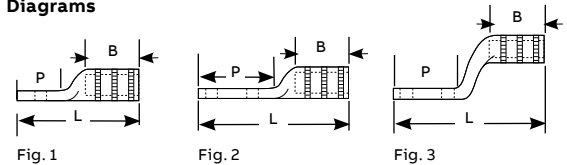

To order a stud size not specified here with a terminal lug, substitute a "-58" suffix (designating a 5/8" stud) for a "-48" suffix (designating a 1/2" stud) to the catalogue number.



Pin terminals

The pins you need for hassle-free terminations

- The high strength and conductivity of aluminum and the flexibility of copper
- No compatibility

Cat. no.	Conductor size (AWG or kcmil)	Decimal range		Tool	Cu pin	P
		Min. O.D.	Max. O.D.			
PTA 1/0	#10 sol.-1/0 ACSR	0.102	0.398	VC 5/6	#2	6
PTA 4/0	#4 sol.-4/0 ACSR	0.204	0.563	VC 5/6	2/0	6
PTA 350	2/0 str.-336.4 (18/1) ACSR	0.414	0.684	VC 6	4/0	6

Diagram

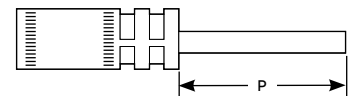

For tin-plated option, add "-TN" suffix to the catalogue number. For other pin lengths, please contact your ABB representative.

Aluminum lugs

Blackburn slotted-tang compression terminal lugs



Fig.1

Fig.2

Fig.3

Fig.4

Compress these lugs with standard tools and dies

- Use with a wide range of aluminum and copper conductors
- Prevents oxidation and keeps out moisture
- Boss fits the indent on the bus, preventing the lug from rotating
- The bus doesn't have to be removed
- RUS listed

Blackburn slotted-tang compression terminal lugs

Cat. no.	Color code	Conductor size (AWG or kcmil)			Sol.	Fig. no.	Installation dies	
		Concentric	Compressed compact				Mech. tool	Hydr. tool
LAC6	Blue	#6 str.	#6	#5	1	BY37, 840	B49EA, U-K840	
LAC4	Orange	#4 str.	#4	#3.	1	BY37, 840	B49EA, U-K840	
LAC3	Purple	#3 str.	-	#2	1	BY37, 840	B49EA, U-K840	
LAC2	Red	#2 str.	#2	#1	1	BY37, 840	B49EA, U-K840	
LAC1	White	#1 str.	#1	1/0	1	BY37, 840	B49EA, U-K840	
LAC10	Yellow	1/0 str.	1/0	2/0	1	BY37, 840	B49EA, U-K840	
LAC20	Grey	2/0 str.	2/0	3/0	2	BY37, 840U	B49EA, K840	
LAC30	Black	3/0 str.	3/0	4/0	2	BY37, 840U	B49EA, K840	
LAC40	Pink	4/0 str.	4/0	-	2	BY37, 840U	B49EA, K840	
LAC42	Orange	#4 str.	#4	#3	2	BY37, 840U	B49EA, K840	
LAC32	Purple	#3 str.	-	#2	2	BY37, 840U	B49EA, K840	
LAC22	Red	#2 str.	#2	#1	2	BY37, 840U	B49EA, K840	
LAC12	White	#1 str.	#1	1/0	2	BY37, 840U	B49EA, K840	
LAC102	Yellow	1/0 str.	1/0	2/0	2	BY37, 840U	B49EA, K840	
LAC202	Grey	2/0 str.	2/0	3/0	2	BY37, 840U	B49EA, K840	
LAC302	Black	3/0 str.	3/0	4/0	2	BY37, 840U	B49EA, K840	
LAC402	Pink	4/0 str.	4/0	-	2	BY37, 840U	B49EA, K840	
LAC25	Green	350, 266.6	250	-	3	-	B80EA, 1.1, 655	
LAC35	Brown	300, 350	350	-	3	-	B80EA, 1.1, 655	
LAC50	Aqua	400, 500	500	-	3	-	B80EA, 1.1, 655	
LAC125	Green	250, 266.8	250	-	4	-	B80EA, 1.1, 655	
LAC135	Brown	300, 350	350	-	4	-	B80EA, 1.1, 655	
LAC150	Aqua	400, 500	500	-	4	-	B80EA, 1.1, 655	

Aluminum lugs

Bi-metallic lugs



CPL 2-48



CPL 600 N

Corrosion-resistant one- and two-hole lugs for ACSR and aluminum conductors

- Provides high strength
- Provides high conductivity and corrosion resistance
- Prevents oxidation and keeps out moisture

Bi-metallic lugs

Cat. no.	Conductor size (AWG or kcmil)		
	ACSR	Al	Bolt size (in.)
CPL series – One hole			
CPL 4-48	#4	#4	½
CPL 2-48	#2	#2	½
CPL 1/0-48	1/0	1/0	½
CPL 4/0-48	4/0	4/0	½
CPL-N series – Two hole			
CPL 4 N	#4	#4	½
CPL 2 N	#2	#2	½
CPL 1/0 N	1/0	1/0	½
CPL 2/0 N	2/0	2/0	½
CPL 3/0 N	3/0	3/0	½
CPL 4/0 N	4/0	4/0-250	½
CPL 300 N	266.8	266.8-300	½
CPL 350 N	336.4	336.4-350	½
CPL 477 N	397.5	396.5-477	½
CPL 556 N	477	500-556.5	½
CPL 600 N	556.5	600	½
CPL 800 N	605-666.6	715.5-800	½
CPL 1000 N	715.5-874.5	874.5-1,000	½
CPL 1113 N	900-1113	1,033.5-1,113	½
CPL 2000 N	1,780-1,900	2,000	½

Aluminum splices

CSA non-tension splices

Compress these lugs with standard tools and dies

- Provides high strength and high conductivity
- Assures proper cable insertion
- Use with aluminum and copper conductors
- Prevents oxidation and keeps out moisture
- Easy identification
- Meets or exceeds ANSI C119.4 specifications

CSA non-tension splices

Cat. no.	Wire size (AWG or kcmil)	CSA die	O.D.	I.D.	Dimensions (in.)	
					L	B
GLE 2	2 str.-Compr-CPT	22	0.635	0.340	2.00	0.96
GLE 1/0	1/0 str.-Compr-CPT	22	0.635	0.420	2.00	0.96
GLE 2/0	2/0 str. Compr-CPT	24	0.840	0.503	2.13	0.96
GLE 3/0	3/0 str.-Compr-CPT	24	0.840	0.547	2.75	1.31
GLE 4/0	4/0 str.-Compr-CPT	24-6T	0.840	0.594	2.75	1.31
GLE 250	250 str.-Compr-CPT	26	1.000	0.620	3.13	1.44
GLE 300	300 str.-Compr-CPT	26-12T	1.000	0.670	3.13	1.44
GLE 350	350 str.-Compr-CPT	28	1.189	0.730	4.00	1.88
GLE 500	500 str.-Compr-CPT	28-12T	1.189	0.835	4.00	1.88
GLE 500-30	500 str.-Compr-CPT	30-12T	1.438	0.880	4.50	2.13
GLE 750	750 str.-Compr-CPT	30	1.438	1.031	4.50	2.13

Diagram

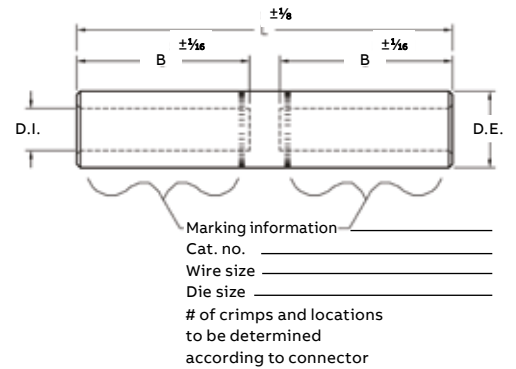

Finish: Tin-plated optional, use suffix "TN".
 Material: E.C. grade aluminum.
 Connector bores are coated with HM 53 a oxide-inhibiting compound and capped.

Aluminum splices

Tin-plated straight splices for general applications



ASC 1000

- Provides high strength and high conductivity
- Assures proper cable insertion
- Use with aluminum and copper conductors
- Prevents oxidation and keeps out moisture
- Easy identification
- Meets or exceeds ANSI C119.4 specifications

Tin-plated straight splices for general applications

Cat. no.	Conductor range (AWG or kcmil)			Dimensions (in.)		Installing dies
	Concentric	Compact	ACSR	L	B	
ASC 6	#6	–	–	1 $\frac{5}{8}$	$\frac{3}{4}$	TP, 29, 161, $\frac{5}{16}$
ASC 4	#4	–	–	2	1	TB, 37, 375, 162
ASC 2	#2	–	–	2	1 $\frac{5}{16}$	TQ, 45, 348, 163, $\frac{1}{2}$, 6A
ASC 1	#1	–	–	2	1 $\frac{5}{16}$	TQ, 45, 348, 163, $\frac{1}{2}$
ASC 1/0	1/0	–	–	2 $\frac{1}{4}$	3 $\frac{1}{32}$	TU, 52, BG, 243, $\frac{5}{8}$
ASC 2/0	2/0	–	–	2 $\frac{5}{16}$	1 $\frac{3}{32}$	TW-TY, 58, 297, $\frac{5}{8}$ -1
ASC 3/0	3/0	–	–	2 $\frac{5}{8}$	1 $\frac{1}{4}$	TV, 66, 167, 467, 10A
ASC 4/0	4/0	–	–	2 $\frac{3}{4}$	1 $\frac{5}{16}$	TX, 71H, 298, 840, 11A
ASC 250	4/0-250	300	4/0	2 $\frac{15}{16}$	1 $\frac{3}{8}$	TX, 76, 249, 840, 11A
ASC 300	266.8-300	350	266.8 (18/1)	3 $\frac{1}{8}$	1 $\frac{1}{16}$	TH, 87H, 251, 470, 1, 12A
ASC 350	336.4-350	400	266.8 (26/7), 336.4 (18/1)	3 $\frac{3}{8}$	1 $\frac{39}{64}$	96, 299, 655, 1 ($\frac{1}{8}$ -1), 13A
ASC 400	397.5-400	–	336.4 (26/7), 397.5 (18/1)	3 $\frac{3}{4}$	1 $\frac{3}{4}$	96, 472, 655, 1 ($\frac{1}{8}$ -1), 13A
ASC 500	477-500	600	397.5 (26/7), 477 (18/1)	3 $\frac{7}{8}$	1 $\frac{27}{32}$	106A, 300, 317, 1 $\frac{15}{16}$, 14A
ASC 600	550-600	–	477 (26/7), 556.5 (18/1)	4 $\frac{1}{8}$	1 $\frac{15}{16}$	1 $\frac{5}{16}$, 115H, 786, 936, 473
ASC 750	700-750	–	636 (26/7)	4 $\frac{11}{16}$	2 $\frac{7}{32}$	140H, 301, 342, 1 $\frac{1}{2}$
ASC 750-608*	700-750	–	636 (26/7)	4 $\frac{11}{16}$	2 $\frac{7}{32}$	125H, 608, 786, 1 $\frac{1}{2}$, 936
ASC 800	800	–	–	4 $\frac{3}{4}$	2 $\frac{1}{4}$	140H, 342, 474, 1 $\frac{1}{2}$
ASC 1000	954-1,000	–	795 (26/7), 954 (45/7)	5 $\frac{1}{4}$	2 $\frac{3}{8}$	161, 292, 302, 319, 1 $\frac{3}{4}$
ASC 1250	1,250	–	–	8	3 $\frac{11}{16}$	161, 727, 352, 1 $\frac{7}{8}$
ASC 1500	1,500	–	–	6 $\frac{1}{2}$	3 $\frac{3}{8}$	189, 478, 728

Diagram

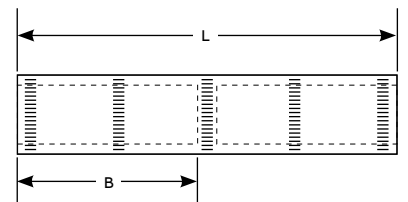

* Not UL listed.

For tin-plated splices add "-TN" suffix to the catalogue number. Tin-plated splices with are UL listed through 1,000 kcmil.

Aluminum splices

Straight splices for general applications



AC 1000

- Provides high strength and high conductivity
- Ensures proper cable insertion
- Use with aluminum and copper conductors
- Prevents oxidation and keeps out moisture
- Easy identification
- Meets or exceeds ANSI C119.4 specifications

Straight splices for general applications

Cat. no.	Conductor range (AWG or kcmil)			Dimensions (in.)		Installing dies
	Concentric	Compact	ACSR	L	B	
AC 4	#4	-	-	2 ¹ / ₄	1	TB, 37, 375
AC 2	#2	-	-	3 ¹⁵ / ₃₂	1 ³⁷ / ₆₄	TQ, 45, 348, 163, 1/2
AC 1	#1	-	-	3 ¹⁵ / ₃₂	1 ³⁷ / ₆₄	TQ, 45, 348, 163, 1/2
AC 1/0	1/0	-	-	3 ¹¹ / ₁₆	1 ¹⁹ / ₃₂	TU, 52, BG, 243, 5/8, 8A
AC 2/0	2/0	-	-	3 ¹¹ / ₁₆	1 ¹⁹ / ₃₂	TU, 52, BG, 243, 5/8, 8A
AC 3/0	3/0	-	-	4	1 ³ / ₄	TV, 66, 167, 781, 247, 10A
AC 4/0	4/0	250	-	3 ³ / ₄	1 ³ / ₄	TX, 71H, 298, 840, 660, 11A
AC 250	4/0-250	-	4/0	5 ¹ / ₄	2 ⁵ / ₁₆	TX, 76, 249, 840, 11A
AC 300	266.8-300	-	266.8 (18/1)	5 ³ / ₄	2 ¹¹ / ₁₆	TH, 87H, 251, 840, 470, 12A
AC 350	336.4-350	-	266.8 (26/7), 336.4 (18/1)	6 ⁵ / ₈	3 ³ / ₈	96, 299, 655, 1 (1/8-1), 13A
AC 400	397.5-400	-	336.4 (26/7), 397.5 (18/1)	7 ⁹ / ₃₂	3 ¹ / ₂	96, 472, 655, 705, 1 (1/8-1), 13A
AC 500	477-500	600	397.5 (26/7, 30/7), 477 (18/1)	7 ¹⁹ / ₃₂	3 ³⁷ / ₆₄	106A, 300, 317, 1 ¹ / ₁₆ , 14A
AC 600	600	-	477 (26/7), 556.5 (18/1)	7 ²⁷ / ₃₂	3 ⁴⁷ / ₆₄	1 ¹ / ₁₆ , 115H, 786, 936, 473
AC 750	700-750	-	636 (26/7)	8 ⁹ / ₃₂	3 ³¹ / ₃₂	140H, 301, 342, 1 ¹ / ₂
AC 800	750-800	-	636 (30/19), 715.5 (54/7)	8 ¹ / ₂	4 ¹ / ₁₆	140H, 474, 342, 724, 1 ¹ / ₂ H, 1 ⁵ / ₈
AC 1000	954-1,000	-	795 (26/7), 954 (45/7)	9 ¹⁵ / ₁₆	4 ⁹ / ₃₂	161, 292, 302, 319, 1 ³ / ₄

Diagram

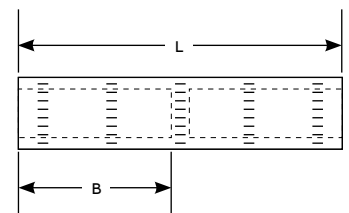

Aluminum splices

Straight reducing splices



AC 500 R 400

Solid center stop ensures proper cable insertion

- Provides high strength and high conductivity
- Use with aluminum and copper conductors
- Prevents oxidation
- Easy identification
- Meets or exceeds ANSI C119.4 specifications

Straight reducing splices

Cat. no.	Wire size (AWG or kcmil)		Dimensions (in.)		Installing dies
	From	To	L	B	
AC 2 R 4	#2	#4	4 ⁹ / ₁₆	1 ⁷ / ₈	TQ, 45, 348, 6A, ½
AC 1/0 R 2	1/0	#2	4 ⁹ / ₁₆	1 ⁷ / ₈	8A, BG, TU, ¾
AC 2/0 R 1	2/0	#1	4 ⁹ / ₁₆	1 ⁷ / ₈	TWTY, 60, 245, 9A, 5 ⁵ / ₈ , 1
AC 3/0 R 1/0	3/0	1/0	5	2	781, TU, 56
AC 4/0 R 2/0	4/0	2/0	5 ¹ / ₄	2 ³ / ₈	TX, 71H, 298, 11A, 840
AC 250 R 3/0	250	3/0	5 ¹ / ₄	2 ³ / ₈	840, 11A, 249, TX
AC 300 R 4/0	300	4/0	8 ³ / ₁₆	3 ¹⁷ / ₃₂	96, 299, 1 ¹ / ₈
AC 350 R 4/0	350	4/0	8 ³ / ₁₆	3 ¹⁷ / ₃₂	96, 299, 1 ¹ / ₈
AC 400 R 250	400	250	8 ¹⁹ / ₃₂	3 ¹¹ / ₁₆	96, 472, 1 ¹ / ₈
AC 500 R 300	500	300	8 ¹⁹ / ₃₂	3 ¹³ / ₁₆	106, 300, 317, 1 ¹ / ₈
AC 500 R 350	500	350	8 ¹¹ / ₁₆	3 ¹³ / ₁₆	106, 300, 317, 1 ¹ / ₈
AC 500 R 400	500	400	8 ⁷ / ₈	3 ¹³ / ₁₆	106, 300, 317, 1 ¹ / ₈
AC 600 R 350	600	350	8 ⁷ / ₈	3 ¹⁵ / ₁₆	115, 473, 1 ¹ / ₈
AC 600 R 500	600	500	9 ¹ / ₄	3 ¹⁵ / ₁₆	115, 473, 1 ¹ / ₈
AC 750 R 500	750	500	9 ⁵ / ₈	4 ⁷ / ₃₂	140, 301, 1 ¹ / ₂
AC 750 R 600	750	600	9 ⁵ / ₈	4 ⁷ / ₃₂	140, 301, 1 ¹ / ₂
AC 1000 R 500	1,000	500	9 ⁷ / ₈	4 ⁵ / ₈	161, 302, 1 ³ / ₄
AC 1000 R 750	1,000	750	9 ⁷ / ₈	4 ⁵ / ₈	161, 302, 1 ³ / ₄

Diagram

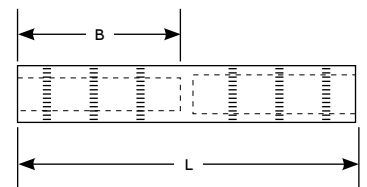

For tin-plated option, add "-TN" suffix to the catalogue number.

Aluminum splices

Straight splices – Common die series



Splices designed for general URD applications

- Lessens your die inventory
- Provides high strength and high conductivity
- Assures proper cable insertion
- Use with aluminum and copper conductors
- Prevents oxidation
- Easy identification
- Meets or exceeds ANSI C119.4 specifications

Straight splices – Common die series

Cat. no.	Conductor range (AWG or kcmil)				Dimensions (in.)		Installing dies
	Concentric	Compressed	Compact	Solid	L	B	
SAC 4	#4	#4	#4	–	3	1 ¹³ / ₃₂	5/8, 8A, BG, TU, 52
SAC 2	#2	#2	#1, #2	#1	3	1 ¹³ / ₃₂	CSA 22, 5/8, 8A, BG
SAC 1	#1	#1	1/0	1/0	3	1 ¹³ / ₃₂	CSA 22, 5/8, 8A, BG
SAC 1/0	1/0	1/0	2/0	2/0	3	1 ¹³ / ₃₂	CSA 22, 5/8, 8A, BG
SAC 2/0	2/0	2/0	3/0	3/0	4	1 ⁷ / ₈	840, 249, TX, CSA 24
SAC 3/0	3/0	3/0	4/0	–	4	1 ⁷ / ₈	840, 249, TX, CSA 24, 845
SAC 4/0	4/0	4/0	4/0, 250	–	4	1 ⁷ / ₈	840, 249, TX, CSA 24, 845
SAC 250	250	250	–	–	4	1 ⁷ / ₈	840, 249, TX, CSA 24, 11A
SAC 300	300	300	–	–	5	2 ³ / ₈	96, 299, 655, 1 (1/8-1), 13A
SAC 350	350	350	–	–	5	2 ³ / ₈	96, 299, 655, 321, 1 (1/8-1), 13A
SAC 400	400	400	500	–	5 ¹¹ / ₁₆	2 ⁵ / ₈	106A, 300, 317, 15A
SAC 500	477-500	–	600	–	5 ¹¹ / ₁₆	2 ⁵ / ₈	106A, 300, 317, 1 ⁵ / ₁₆ , 15A
SAC 600	600	–	–	–	7	3 ³ / ₈	1 ¹ / ₂ , 140, 301, 724
SAC 750	700-750	–	–	–	7	3 ¹³ / ₃₂	140H, 301, 342, 724, 1 ¹ / ₂
SAC 1000	1,000	–	–	–	7	3 ⁵ / ₁₆	1 ³ / ₄ , 161, 302, 292, 319

Diagram

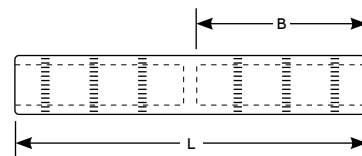

Aluminum splices

Straight reducing splices – Common die series



Reducers for general URD applications

- Lessens your die inventory
- Use with aluminum and copper conductors

- Prevents oxidation
- Easy identification
- Meets or exceeds ANSI C119.4 specifications

Straight reducing splices – Common die series

Cat. no.	Side A			Side B			A-B (in.)	L (in.)	Installing dies
	Concentric/ compressed	Compact	Solid	Concentric/ compressed	Compact	Solid			
SAC 4 R 6	#4	#4	–	#6	#6	–	1 ⁷ / ₁₆	3	CSA 22, ³ / ₈ , BG, 243
SAC 2 R 4	#2	#1, #2	#1	#4	#4	–	1 ⁷ / ₁₆	3	CSA 22, ³ / ₈ , BG, 243
SAC 1 R 2	#1	1/0	1/0	#2	#1, #2	#1	1 ⁷ / ₁₆	3	CSA 22, ³ / ₈ , BG, 243
SAC 1/0 R 4	1/0	2/0	2/0	#4	#4	–	1 ⁷ / ₁₆	3	CSA 22, ³ / ₈ , BG, 243
SAC 1/0 R 2	1/0	2/0	2/0	#2	#1, #2	#1	1 ⁷ / ₁₆	3	CSA 22, ³ / ₈ , BG, 243
SAC 1/0 R 1	1/0	2/0	2/0	#1	1/0	1/0	1 ⁷ / ₁₆	3	CSA 22, ³ / ₈ , BG, 243
SAC 2/0 R 2	2/0	3/0	3/0	#2	#1, #2	#1	1 ⁷ / ₈	4	840, 249, TX, CSA 24
SAC 2/0 R 1/0	2/0	3/0	3/0	1/0	2/0	2/0	1 ⁷ / ₈	4	840, 249, TX, CSA 24
SAC 3/0 R 1/0	3/0	4/0	–	1/0	2/0	2/0	1 ⁷ / ₈	4	840, 249, TX, CSA 24
SAC 3/0 R 2/0	3/0	4/0	–	2/0	3/0	3/0	1 ⁷ / ₈	4	840, 249, TX, CSA 24
SAC 4/0 R 2	4/0	250	–	#2	#1, #2	#1	1 ⁷ / ₈	4	840, 249, TX, CSA 24
SAC 4/0 R 1/0	4/0	250	–	1/0	2/0	2/0	1 ⁷ / ₈	4	840, 249, TX, CSA 24
SAC 4/0 R 2/0	4/0	250	–	2/0	3/0	3/0	1 ⁷ / ₈	4	840, 249, TX, CSA 24
SAC 250 R 3/0	250	–	–	3/0	4/0	–	1 ⁷ / ₈	4	840, 249, TX, CSA 24
SAC 250 R 4/0	250	–	–	4/0	250	–	1 ⁷ / ₈	4	840, 249, TX, CSA 24
SAC 300 R 250	300	–	–	4/0-250	–	–	2 ³ / ₈	5	96, 299, 655, 1 (¹ / ₈ -1), 13A
SAC 350 R 2	350	–	–	#2	#1, #2	#1	2 ³ / ₈	5	96, 299, 655, 1 (¹ / ₈ -1), 13A
SAC 350 R 1/0	350	–	–	1/0	2/0	2/0	2 ³ / ₈	5	96, 299, 655, 1 (¹ / ₈ -1), 13A
SAC 350 R 2/0	350	–	–	2/0	3/0	3/0	2 ³ / ₈	5	96, 299, 655, 1 (¹ / ₈ -1), 13A
SAC 350 R 3/0	350	–	–	3/0	4/0	–	2 ³ / ₈	5	96, 299, 655, 1 (¹ / ₈ -1), 13A
SAC 350 R 4/0	350	–	–	4/0	250	–	2 ³ / ₈	5	96, 299, 655, 1 (¹ / ₈ -1), 13A
SAC 350 R 250	350	–	–	250	–	–	2 ³ / ₈	5	96, 299, 655, 1 (¹ / ₈ -1), 13A
SAC 500 R 2	500	–	–	#2	–	–	2 ²¹ / ₃₂	5 ¹¹ / ₁₆	1 ⁵ / ₁₆ , 15A, 300, 106, 317
SAC 500 R 1/0	500	–	–	1/0	–	–	2 ²¹ / ₃₂	5 ¹¹ / ₁₆	1 ⁵ / ₁₆ , 15A, 300, 106, 317
SAC 500 R 2/0	500	–	–	2/0	–	–	2 ²¹ / ₃₂	5 ¹¹ / ₁₆	1 ⁵ / ₁₆ , 15A, 300, 106, 317
SAC 500 R 3/0	500	–	–	3/0	–	–	2 ²¹ / ₃₂	5 ¹¹ / ₁₆	1 ⁵ / ₁₆ , 15A, 300, 106, 317
SAC 500 R 4/0	500	–	–	4/0	250	–	2 ²¹ / ₃₂	5 ¹¹ / ₁₆	1 ⁵ / ₁₆ , 15A, 300, 106, 317
SAC 500 R 300	500	–	–	300	–	–	2 ²¹ / ₃₂	5 ¹¹ / ₁₆	1 ⁵ / ₁₆ , 15A, 300, 106, 317
SAC 500 R 350	500	–	–	350	–	–	2 ²¹ / ₃₂	5 ¹¹ / ₁₆	1 ⁵ / ₁₆ , 15A, 300, 106, 317
SAC 500 R 400	500	–	–	400	–	–	2 ²¹ / ₃₂	5 ¹¹ / ₁₆	1 ⁵ / ₁₆ , 15A, 300, 106, 317
SAC 750 R 1/0	750	–	–	1/0	–	–	3	6 ¹ / ₄	140H, 301, 342
SAC 750 R 4/0	750	–	–	4/0	250	–	3	6 ¹ / ₄	140H, 301, 342
SAC 750 R 250	750	–	–	250	–	–	3	6 ¹ / ₄	140H, 301, 342
SAC 750 R 350	750	–	–	350	–	–	3	6 ¹ / ₄	140H, 301, 342
SAC 750 R 500	750	–	–	500	–	–	3	6 ¹ / ₄	140H, 301, 342
SAC 1000 R 400	1,000	–	–	400	–	–	3 ³ / ₈	7	161, 302, 292, 319, 1- ³ / ₄
SAC 1000 R 500	1,000	–	–	500	–	–	3 ³ / ₈	7	161, 302, 292, 319, 1- ³ / ₄
SAC 1000 R 750	1,000	–	–	750	–	–	3 ³ / ₈	7	161, 302, 292, 319, 1- ³ / ₄

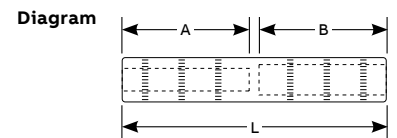

Aluminum splices

Tin-plated straight splices – 5/8-in. Common die series



Built to resist corrosion and provide high strength and high conductivity

- Provides high strength and high conductivity
- Assures accurate wire positioning and forces oxide inhibitor over and through conductor strands
- Use with aluminum and copper conductors

- Resists corrosion and extends shelf life
- Improves contact and seals out moisture after installation
- Seal splices from contaminants
- Easy identification and installation
- Meets or exceeds ANSI C119.4 specifications

Tin-plated straight splices – 5/8-in. Common die series

Cat. no.	Wire size (AWG or kcmil)		Conductor		Installing dies	L (in.)
	A	B	A	B		
SG 88	#8	#8	Al-Cu	Al-Cu	5/8, 8A, BG, TU, 243	2
SG 68	#6	#8	Al-Cu	Al-Cu	5/8, 8A, BG, TU, 243	2
SG 66	#6	#6	Al-Cu	Al-Cu	5/8, 8A, BG, TU, 243	2
SG 48	#4	#8	Al-Cu	Al-Cu	5/8, 8A, BG, TU, 243	2
SG 46	#4	#6	Al-Cu	Al-Cu	5/8, 8A, BG, TU, 243	2
SG 44	#4	#4	Al-Cu	Al-Cu	5/8, 8A, BG, TU, 243	2
SG 24	#2	#4	Al-Cu	Al-Cu	5/8, 8A, BG, TU, 243	2
SG 22	#2	#2	Al-Cu	Al-Cu	5/8, 8A, BG, TU, 243	2
SG 11	#1	#1	Al-Cu	Al-Cu	5/8, 8A, BG, TU, 243	2
SG 106	1/0	#6	Al-Cu	Al-Cu	5/8, 8A, BG, TU, 243	2
SG 104	1/0	#4	Al-Cu	Al-Cu	5/8, 8A, BG, TU, 243	2
SG 102	1/0	#2	Al-Cu	Al-Cu	5/8, 8A, BG, TU, 243	2
SG 1010	1/0	1/0	Al-Cu	Al-Cu	5/8, 8A, BG, TU, 243	2
SG 206	2/0	#6	Al	Al	5/8, 8A, BG, TU, 243	2 1/8
SG 204	2/0	#4	Al	Al	5/8, 8A, BG, TU, 243	2 1/8
SG 202	2/0	#2	Al	Al	5/8, 8A, BG, TU, 243	2 1/8
SG 2010	2/0	1/0	Al	Al	5/8, 8A, BG, TU, 243	2 1/8
SG 2020	2/0	2/0	Al	Al	5/8, 8A, BG, TU, 243	2 1/8

Diagram

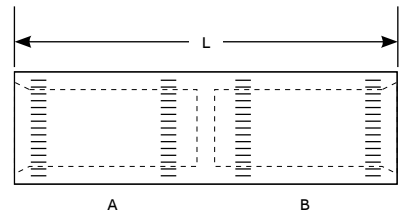

Aluminum tapered tees

For aluminum and copper connections



AT 350-350

For aluminum and copper connections, these dual-rated components suit you to a tee

- Provides high strength and high conductivity
- Use with aluminum and copper conductors
- Prevents oxidation
- Easy identification
- Meets or exceeds ANSI C119.4 specifications

For aluminum and copper connections

Cat. no.	Conductor range (AWG or kcmil)		Dimensions (in.)	
	Run	Tap	L	T
AT 2-4	#2	#4	5½	2½
AT 2-2	#2	#2	5½	2½
AT 1/0-4	1/0	#4	5½	2½
AT 1/0-2	1/0	#2	5½	2½
AT 1/0-1/0	1/0	1/0	5½	2½
AT 2/0-2	2/0	#2	5½	2½
AT 2/0-1/0	2/0	1/0	6	2½
AT 2/0-2/0	2/0	2/0	6	2½
AT 3/0-2	3/0	#2	6	3
AT 3/0-1/0	3/0	1/0	6	3
AT 3/0-3/0	3/0	3/0	6	3
AT 4/0-2	4/0	#2	6	3
AT 4/0-1/0	4/0	1/0	6	3
AT 4/0-2/0	4/0	2/0	6	3
AT 4/0-4/0	4/0	4/0	6	3¾
AT 250-2	250	#2	6	3¾
AT 250-1/0	250	1/0	6	3¾
AT 250-2/0	250	2/0	6	3¾
AT 250-3/0	250	3/0	6	3¾
AT 250-250	250	250	6	3¾
AT 300-1/0	300	1/0	6¾	3¾
AT 300-2/0	300	2/0	6¾	3¾
AT 300-4/0	300	4/0	6¾	3¾
AT 300-300	300	300	6¾	3¾

Cat. no.	Conductor range (AWG or kcmil)		Dimensions (in.)	
	Run	Tap	L	T
AT 350-2	350	#2	6¾	2½
AT 350-1/0	350	1/0	6¾	2½
AT 350-3/0	350	3/0	6¾	3
AT 350-4/0	350	4/0	6¾	3
AT 350-350	350	350	6¾	3¾
AT 500-1/0	500	1/0	8	3
AT 500-4/0	500	4/0	8	3
AT 500-350	500	350	8	3¾
AT 500-500	500	500	8	3¾
AT 750-1/0	750	1/0	8	2½
AT 750-4/0	750	4/0	8	3
AT 750-350	750	350	8	3¾
AT 750-500	750	500	9	3¾
AT 750-750	750	750	9	3¾
AT 1000-4/0	1,000	4/0	9¾	3¾
AT 1000-350	1,000	350	9¾	3¾
AT 1000-500	1,000	500	9¾	5½
AT 1000-750	1,000	750	9¾	7¾
AT 1000-1000	1,000	1,000	9¾	7¾

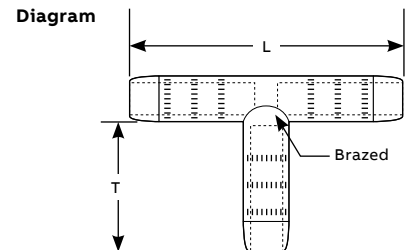

For tin-plated option, add "-TN" suffix to the catalogue number.
For other available sizes, please consult your ABB representative.

Aluminum tapered tees

For high-voltage applications



ATT 350-350

Tees available in many run and tap sizes for your high-voltage applications

- Provides high strength and high conductivity
- Enable use in high-voltage applications up to 69 kV
- Use with aluminum and copper conductors
- Prevents oxidation
- Easy identification
- Meets or exceeds ANSI C119.4 specifications

For high-voltage applications

Cat. no.	Conductor range (AWG or kcmil)		Dimensions (in.)	
	Run	Tap	L	T
ATT 2-4	#2	#4	4¼	2½
ATT 2-2	#2	#2	4¼	2½
ATT 1/0-4	1/0	#4	5½	2½
ATT 1/0-2	1/0	#2	5½	2½
ATT 1/0-1/0	1/0	1/0	5½	2½
ATT 2/0-2	2/0	#2	6	2½
ATT 2/0-1/0	2/0	1/0	6	2½
ATT 2/0-2/0	2/0	2/0	6	2½
ATT 3/0-2	3/0	#2	6⅝	3
ATT 3/0-1/0	3/0	1/0	6⅝	3
ATT 3/0-3/0	3/0	3/0	6⅝	3
ATT 4/0-2	4/0	#2	6⅝	2½
ATT 4/0-1/0	4/0	1/0	6⅝	2½
ATT 4/0-2/0	4/0	2/0	6⅝	2½
ATT 4/0-4/0	4/0	4/0	6⅝	3
ATT 250-2	250	#2	6⅝	3
ATT 250-1/0	250	1/0	6⅝	3
ATT 250-2/0	250	2/0	6⅝	3
ATT 250-3/0	250	3/0	6⅝	3
ATT 250-250	250	250	6⅝	3
ATT 300-1/0	300	1/0	6⅝	3½
ATT 300-2/0	300	2/0	6⅝	3½
ATT 300-4/0	300	4/0	6⅝	3½
ATT 300-300	300	300	6⅝	3½

Cat. no.	Conductor range (AWG or kcmil)		Dimensions (in.)	
	Run	Tap	L	T
ATT 350-2	350	#2	6⅝	2½
ATT 350-1/0	350	1/0	6⅝	2½
ATT 350-3/0	350	3/0	6⅝	3
ATT 350-4/0	350	4/0	6⅝	3
ATT 350-350	350	350	6⅝	3½
ATT 400-1/0	400	1/0	7¾	4
ATT 400-4/0	400	4/0	7¾	4
ATT 400-400	400	400	7¾	4
ATT 500-1/0	500	1/0	7¾	4
ATT 500-4/0	500	4/0	8	3
ATT 500-350	500	350	8	3½
ATT 500-500	500	500	8	5½
ATT 750-1/0	750	1/0	8	3
ATT 750-4/0	750	4/0	8	3
ATT 750-350	750	350	8	3½
ATT 750-500	750	500	9	5½
ATT 750-750	750	750	9	4
ATT 1000-4/0	1,000	4/0	9⅞	3½
ATT 1000-350	1,000	350	9⅞	3½
ATT 1000-500	1,000	500	9⅞	5½
ATT 1000-750	1,000	750	9⅞	6
ATT 1000-1000	1,000	1,000	9⅞	6
ATT 1500-1500	1,500	1,500	14	6

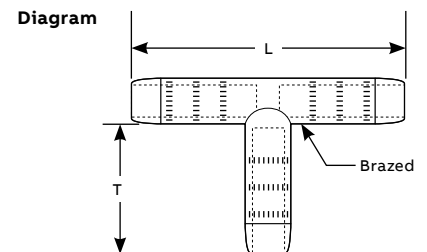

For tin-plated option, add "-TN" suffix to the catalogue number.
For other available sizes, please consult your ABB representative.

Copper lugs

Copper tin-plated one-hole lugs



L 750-48

Tin-plated lugs resist corrosion

- Provides high conductivity
- Minimizes voltage drop
- Easy identification
- UL listed and CSA certified

Copper tin-plated one-hole lugs



Cat. no.	Wire size		Installing dies
	(AWG or kcmil)	Bolt size (in.)	
L 8-10	#8	10	TC, 21, 171, 236
L 8-14		1/4	
L 8-38		3/8	
L 8-48		1/2	
L 6-10	#6	10	7, TE, 24
L 6-14		1/4	
L 6-516		5/16	
L 6-38		3/8	
L 4-14	#4	1/4	
L 4-516		5/16	
L 4-38		3/8	
L 2-14	#2	1/4	3/8, 10, TL-TN, 33, 162
L 2-516		5/16	
L 2-38		3/8	
L 2-48		1/2	
L 1-14	#1	1/4	11, TB, 37
L 1-516		5/16	
L 1-38		3/8	
L 1-48		1/2	
L 1/0-516	1/0	5/16	1/2, 12, TQ, 42, 163
L 1/0-38		3/8	
L 1/0-48		1/2	
L 2/0-516	2/0	5/16	13, TS, 45, 164, 241
L 2/0-38		3/8	
L 2/0-48		1/2	



Cat. no.	Wire size		Installing dies
	(AWG or kcmil)	Bolt size (in.)	
L 3/0-516	3/0	5-16	5/8, 14, TU, 50, 243, BG
L 3/0-38		3/8	
L 3/0-48		1/2	
L 4/0-516	4/0	5/16	15, TW-TY, 54, 243
L 4/0-38-HM		3/8	
L 4/0-48		1/2	
L 250-38	250	3/8	11/16, 16, TR, 60, 166
L 250-48		1/2	
L 300-38	300	3/8	781, 17, TV, 66
L 300-48		1/2	
L 300-58		5/8	
L 350-38	350	3/8	840, 18, TX, 71
L 350-48		1/2	
L 350-58		5/8	
L 400-48	400	1/2	840, 19, TX, 76
L 400-58		5/8	
L 500-48	500	1/2	20, TH, 87, 281
L 500-58		5/8	
L 600-48	600	1/2	1 1/8-1, 96
L 600-58		5/8	
L 750-48	750	1/2	1 1/8-2, 106
L 750-58		5/8	
L 750-68		3/4	
L 1000-48	1000	1/2	642, 125
L 1000-58		5/8	
L 1000-68		3/4	

Copper lugs

Tin-plated two-hole straight and stacking NEMA lugs for general applications



L 2/0 N



L 1000 NT

- Provides high conductivity
- Minimizes voltage drop
- Resists corrosion
- Provides 3/4" and 7/8" bolt hole centers for added versatility
- UL listed and CSA certified

Tin-plated two-hole straight and stacking NEMA lugs for general applications



Straight lug Cat. no.	Stacking lug Cat. no.	Wire size (AWG or kcmil)	Bolt size (in.)	Installing dies	Dimensions (in.)							
					B	C	L	P	S	W	H	
L 6-214	-	#6	1/4	7, TE, 27	1 1/8	5/16	2 13/16	1 5/16	5/8	7/16	-	
L 6-2516	-		5/16		1 1/8	5/16	2 11/16	1 5/16	5/8	7/16		
L 6 N	-		1/2		1 1/8	5/8	5	3 3/8	1 3/4	3/4		
L 4-214	-	#4	1/4	5/16, 8, TP, 29, IC, 1	1 1/8	5/16	2 3/4	1 5/16	5/8	1/2		
L 4-2516	-		5/16		1 1/8	5/16	2 3/4	1 5/16	5/8	1/2		
L 4 N	-		1/2		1 1/8	5/8	5	3 3/8	1 3/4	3/4		
L 2-214	-	#2	1/4	3/8, 10, TL-TN, 33, 162	1 1/4	3/8	3 3/8	1 1/2	5/8	5/8		
L 2-2516	-		5/16		1 1/4	3/8	3 5/16	1 5/8	3/4 - 7/8	5/8		
L 2 N	-		1/2		1 1/4	5/8	4 3/4	3	1 5/16	3/4		
L 1-214	-	#1	1/4	3/8, 11, TB, 37	1 3/8	3/8	3 3/8	1 5/8	5/8	11/16		
L 1-2516	-		5/16		1 1/2	5/16	3 3/8	1 5/8	3/4 - 7/8	11/16		
L 1 N	-		1/2		1 1/2	5/8	4 7/8	3	1 3/4	3/4		
L 1/0-238	-	1/0	3/8	1/2, 12, TQ, 42, 163	1 3/8		3 7/16	1 5/8	7/8	3/4		
L 1/0-2516	-		5/16		1 3/8		3 7/16	1 5/8	3/4 - 7/8	3/4		
L 1/0 N	-		1/2		1 7/16		4 7/8	3	1 3/4	3/4		
L 2/0-238	-	2/0	3/8	5/16, 13, TS, 45, 164	1 1/2		5 1/16		7/8			
L 2/0 N	SL 2/0 N		1/2		1 1/2		5 1/16		7/8	1 1/2		
L 3/0-238	-	3/0	3/8	5/8, 14, TU, 50, BG	1 1/2		5 3/8		15/16	-		
L 3/0 N	SL 3/0 N		1/2		1 1/2		5 3/8		15/16	1 5/8		
L 4/0-238	-	4/0	3/8	5/8-1, 15, TW-TY, 54, 243	1 5/8		5 3/16		11/16	-		
L 4/0 N	SL 4/0 N		1/2		1 5/8		5 3/16		11/16	1 9/16		
L 250-238	-	250	3/8	11/16, 16, TR, 60, 116	1 11/16		5 3/16		1 3/8	-		
L 250 N	SL 250 N		1/2		1 11/16		5 7/16		1 3/8	1 1/16		
L 300-238	-	300	3/8	781, 17, TV, 66, 11/16	2		5 3/4		1 3/4	-		
L 300 N	SL 300 N		1/2		2		5 3/4		1 3/4	1 3/4		
L 350-238	-	350	3/8	840, 18, TX, 71	2		5 3/4		1 15/16	-		
L 350 N	SL 350 N		1/2		1 7/8		5 3/4		1 15/16			
L 400-238	-	400	3/8	15/16, 19, TX, 76, 840	2 1/8		6	3 1/16	1 7/16			
L 400 N	SL 400 N		1/2		2 1/8		6	3 3/8	1 7/16	2 1/8		
L 500 N	SL 500 N	500	1/2	1, 20, TH, 87, 251	2 1/4		6 1/16	3 3/8	1 9/16			
L 600 N	SL 600 N	600	1/2	1 (1/8-1), 22, 96	2 5/8		6 3/4	3 3/8	1 11/16	2 3/16		
L 750 N	SL 750 N	750	1/2	1 5/16, 106, 24	2 13/16		7	3 3/8	1 3/4	2 5/8		
L 1000 NT	SL 1000 NT	1000	1/2	27, 1 1/2, 125	2 15/16		7 1/4	3 3/4	1 3/4	3		
L 1250 N*	-	1250	1/2	150, 29, 1 5/8	3		7 3/8	3 3/8	2 3/16	-		
L 1500 N*	-	1500	1/2	1 3/4, 31, 150	3 3/16		7 1/2	3	2 11/16			
L 2000 N*	-	2000	1/2	2.00, 34, 175	3 3/16		8 1/16	3 3/16	3 3/16			

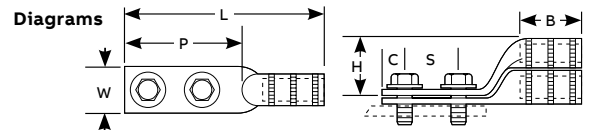

The "N" suffix on the catalogue number indicates NEMA bolt spacing of 1 3/4". For other available sizes, please consult your ABB representative.

* L 1250 N, L 1500 N and L 2000 N are not UL listed or CSA certified.

Copper lugs

Tin-plated four-hole NEMA lugs



L 1500 4N

These four-hole NEMA lugs are great for a standard installation

- Resistance against corrosion
- Easy identification

Tin-plated four-hole NEMA lugs

Cat. no.	Wire size (AWG or kcmil)	Bolt size (in.)	Installing dies	Dimensions (in.)					
				B	C	L	P	W	
L 750 4N	750	$\frac{1}{2}$	106, 21, 209, $1\frac{5}{16}$	$4\frac{3}{8}$	$\frac{5}{8}$	$8\frac{7}{8}$	$3\frac{3}{16}$	3	
L 1000 4N	1,000	$\frac{1}{2}$	786, $1\frac{1}{2}$, 27, 125, 642	$4\frac{3}{8}$	$\frac{5}{8}$	$9\frac{1}{8}$	$3\frac{5}{16}$	3	
L 1500 4N	1,500	$\frac{1}{2}$	$1\frac{3}{4}$, 31, 150, 302	$3\frac{3}{16}$	$\frac{5}{8}$	$7\frac{1}{2}$	3	$2\frac{5}{8}$	
L 2000 4N	2,000	$\frac{1}{2}$	2.00, 34, 175	$3\frac{3}{16}$	$\frac{5}{8}$	$8\frac{3}{16}$	$3\frac{3}{16}$	$3\frac{1}{16}$	

Diagram

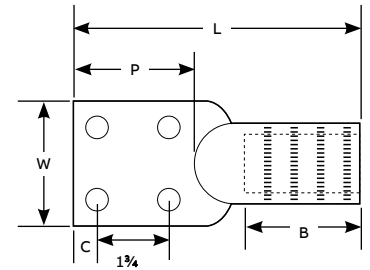

Copper lugs

Heavy-duty two-hole NEMA lugs



- Heavy-wall lugs for grounding and other critical applications
- Able to handle the most severe heavy-loading applications
- Ease cable insertion

Heavy-duty two-hole NEMA lugs

Meets IEEE 837-2014 requirements

Cat. no.	Wire size (AWG or kcmil)	Installing dies*	Dimensions (in.)			
			B	L	P	W
HDL 2 N	#2	15508SS	1½	5¼	3	13/16
HDL 1 N	#1	15526SS	1½	5¼	3	13/16
HDL 1/0 N	1/0	15530SS	1½	5¼	3	13/16
HDL 2/0 N	2/0	15511SS	1¾	5½	3	15/16
HDL 3/0 N	3/0	15532SS	1 ¹¹ / ₁₆	5 ³ / ₁₆	3	1
HDL 4/0 N	4/0	15514SS	1¾	5 ⁵ / ₈	3	1 ¹ / ₈
HDL 250 N	250	15517SS	1¾	5 ⁵ / ₈	3	1 ¹ / ₄
HDL 300 N	300	15506SS	2¼	5 ¹³ / ₁₆	3	1 ³ / ₈
HDL 350 N	350	15503SS	2 ⁵ / ₁₆	6 ⁹ / ₁₆	3	1 ¹ / ₁₆
HDL 500 N	500	15609SS	2 ⁵ / ₈	6 ³ / ₈	3	1 ³ / ₄
HDL 750 N**	750	Consultez votre représentant ABB.	3 ⁵ / ₈	7 ³ / ₁₆	3	2 ³ / ₁₆
HDL 1000 N**	1,000	Consultez votre représentant ABB.	4 ⁵ / ₈	9 ⁵ / ₈	3 ⁵ / ₈	2 ⁵ / ₈

Diagram

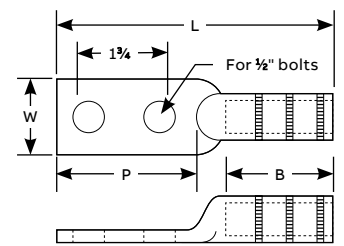

Note: For tin plating, add suffix “-TN” after the catalogue number.
For oxide-inhibiting compound, contact your ABB representative.

*These dies may be used with the TBM15CR-LI or TBM15I compression tools. Please note that the die adapter 15500-TB is required for use with these tools.

** Do not meet IEEE 837-2014 requirements.

Copper lugs

Copper heavy-duty four-hole NEMA lugs



HDL 4/0 4N

Heavy-wall lugs for grounding and other critical applications

- Able to handle the most severe heavy-loading applications
- Ease cable insertion

Copper heavy-duty four-hole NEMA lugs

Cat. no.	Wire size (AWG or kcmil)	Installing dies	Dimensions (in.)			
			B	L	P	W
HDL 4/0 4N	4/0	71, 168, 840	1 $\frac{3}{4}$	4 $\frac{3}{4}$	3	3
HDL 350 4N	350	96, 267, 1 (1/8-1)	2 $\frac{5}{16}$	6 $\frac{9}{16}$	3	3
HDL 500 4N	500	112, 210, 1 $\frac{1}{8}$	3 $\frac{1}{8}$	6 $\frac{3}{8}$	3	3
HDL 750 4N	750	138, 627, 1 $\frac{1}{2}$	3 $\frac{1}{8}$	8 $\frac{1}{4}$	3	3

Diagram

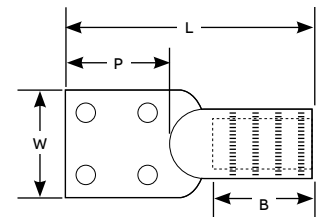

For tin-plated option, add "-TN" suffix to the catalogue number.
For oxide-inhibiting compound, please consult your ABB representative.

Copper splices

Tin-plated straight splices



SC 1000

Made from electrolytic seamless copper tubing, these splices can handle your heavy-duty applications

- Equalizes cable insertion
- Resists corrosion
- Easy identification

Tin-plated straight splices



Standard barrel Cat. no.	Long barrel Cat. no.	Wire size (AWG or kcmil)	Standard barrel		Long barrel		Installing dies
			B (in.)	L (in.)	B (in.)	L (in.)	
SC 8	C 8	#8	7/16	1 1/16	1 1/16	2 1/4	TC, 21, 236
SC 6	C 6	#6	13/16	1 3/4	1 1/8	2 3/8	TE, 24
SC 4	C 4	#4	13/16	1 3/4	1 1/8	2 3/8	5/16, 8, 29, 161, TP
SC 2	C 2-HM	#2	7/8	1 7/8	1 1/4	2 3/8	3/8, 10, TL-TN, 33, 162
SC 1-HM	C 1-HM	#1	7/8	1 7/8	1 3/8	2 7/8	11, TB, 37
SC 1/0	C 1/0	1/0	7/8	1 7/8	1 3/8	2 7/8	1/2, 12, TQ, 42, 163
SC 2/0-HM	C 2/0	2/0	15/16	2	1 1/2	3 1/8	9/16, 13, TS, 45, 164
SC 3/0	C 3/0	3/0	1	2 1/8	1 1/2	3 1/8	5/8, 14, TU, 50, 243, BG
SC 4/0	C 4/0	4/0	1	2 1/8	1 5/8	3 3/8	5/8-1, 15, TW-TY, 54
SC 250-HM	C 250-HM	250	1 1/16	2 1/4	1 5/8	3 3/8	1 1/16, 16, TR, 60, 166
SC 300	C 300-HM	300	1 1/16	2 1/4	2	4 1/8	17, 66, TV, 781
SC 350	C 350	350	1 1/8	2 3/8	2	4 1/8	840, 18, TX, 71, 168, 208
SC 400	C 400	400	1 3/16	2 1/2	2 1/8	4 3/8	1 5/16, 19, TX, 76, 840
SC 500	C 500-HM	500	1 3/8	2 7/8	2 1/4	4 5/8	1, 20, TH, 87, 251
SC 600	C 600-HM	600	1 3/8	2 7/8	2 11/16	5 1/2	1 (5/8-1), 22, 96
SC 750	C 750	750	1 5/8	3 3/8	2 7/8	5 7/8	1 1/8, 2, 24, 106
SC 1000-HM	C 1000	1,000	1 7/8	3 7/8	3	6 1/8	1 1/2, 27, 125, 642
SC 1500*	C 1500*	1,500	2	4 1/8	3 3/16	6 1/2	1 3/4, 31, 150
SC 2000*	C 2000*	2,000	2 1/4	4 5/8	3 7/16	7	2.00, 34, 175

Diagrams

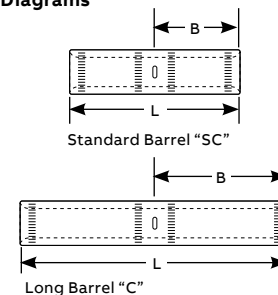

* SC 1500, SC 2000, C 1500 and C 2000 are not UL listed or CSA certified.

Copper splices

Tin-plated straight oil-stop splices

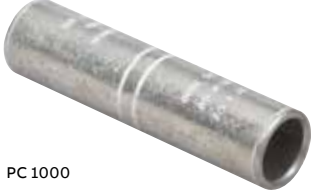

PC 1000

Electrolytic seamless copper tubing provides high conductivity and minimizes voltage drop

- Resists oil
- Resists corrosion

Tin-plated straight oil-stop splices

Cat. no.	Wire size (AWG or kcmil)	Installing dies	Dimensions (in.)	
			B	L
PC 6	#6	7, TE, 24	1 $\frac{1}{8}$	2 $\frac{3}{8}$
PC 4-HM	#4	$\frac{5}{16}$, 8, TP, 29, 161	1 $\frac{1}{8}$	2 $\frac{3}{8}$
PC 2-HM	#2	$\frac{3}{8}$, 10, TL-TN, 162	1 $\frac{1}{4}$	2 $\frac{5}{8}$
PC 1-HM	#1	$\frac{1}{2}$, 11, TB, 37, 276	1 $\frac{3}{8}$	2 $\frac{7}{8}$
PC 1/0	1/0	$\frac{1}{2}$, 12, TQ, 42, 163	1 $\frac{3}{8}$	2 $\frac{7}{8}$
PC 2/0	2/0	$\frac{5}{16}$, 13, TS, 164, 45	1 $\frac{1}{2}$	3 $\frac{1}{8}$
PC 3/0	3/0	$\frac{5}{8}$, 14, TU, 243, BG 50	1 $\frac{1}{2}$	3 $\frac{1}{8}$
PC 4/0	4/0	54, $\frac{5}{8}$ -1, 15, TW-TY	1 $\frac{5}{8}$	3 $\frac{3}{8}$
PC 250-HM	250	$1\frac{1}{16}$, 16, TR, 166, 60	1 $\frac{5}{8}$	3 $\frac{3}{8}$
PC 300	300	781, 17, 66, TV	2	4 $\frac{1}{8}$
PC 350	350	71, 840, 18, TX, 168, 208	2	4 $\frac{1}{8}$
PC 400	400	76, $1\frac{5}{16}$, 19, TX, 840	2 $\frac{1}{8}$	4 $\frac{3}{8}$
PC 500	500	251, 1, 20, TH 87	2 $\frac{1}{4}$	4 $\frac{5}{8}$
PC 600-HM	600	1 ($\frac{1}{8}$)-1, 22, 96	2 $\frac{11}{16}$	5 $\frac{1}{2}$
PC 750	750	1 $\frac{1}{16}$, 24, 106	2 $\frac{7}{8}$	5 $\frac{7}{8}$
PC 1000	1,000	1 $\frac{1}{2}$, 27, 125, 642	3	6 $\frac{1}{8}$

Diagram

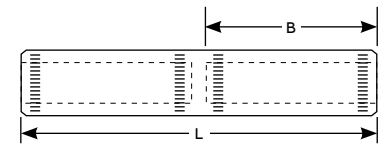

Copper splices

Tin-plated tapered splices

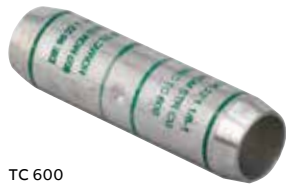

TC 600

High-voltage, oil, harsh environments — these splices can handle it all

- Provides high conductivity, minimizes voltage drop
- Enable use in high-voltage installations up to 69 kV
- Resists corrosion and extends shelf life
- Equalizes cable insertions
- Resists oil

Tin-plated tapered splices

Dimpled center stop Cat. no.	Solid center oil stop Cat. no.	Wire size (AWG or kcmil)	Installing dies	Dimensions (in.)	
				B	L
TC 6	PTC 6	#6	7, TE, 24, 5/16	7/8	1 ²⁹ / ₃₂
TC 4	PTC 4	#4	5/16, 8, TP, 29	7/8	1 ²⁹ / ₃₂
TC 2	PTC 2	#2	3/8, 10, TL-TN, 33	31/32	2 ¹ / ₁₆
TC 1	PTC 1	#1	3/8, 11, TB, 37	31/32	2 ¹ / ₁₆
TC 1/0	PTC 1/0	1/0	1/2, 12, TQ, 42	31/32	2 ¹ / ₁₆
TC 2/0	PTC 2/0	2/0	9/16, 13, TS, 45	1 ⁷ / ₃₂	2 ⁷ / ₃₂
TC 3/0	PTC 3/0	3/0	5/8, 14, TU, 50	1 ¹ / ₈	2 ¹³ / ₃₂
TC 4/0	PTC 4/0	4/0	5/8-1, 15, TW-TY, 9A	1 ¹ / ₈	2 ³ / ₈
TC 250	PTC 250	250	1 ¹ / ₁₆ , 16, TR, 60	1 ⁷ / ₃₂	2 ⁹ / ₁₆
TC 300	PTC 300	300	781, 17, 66, TV	1 ¹ / ₄	2 ⁵ / ₈
TC 350-HM	PTC 350	350	840, 18, TX, 71	1 ⁹ / ₁₆	2 ²⁵ / ₃₂
TC 400	PTC 400	400	840, 1 ⁵ / ₁₆ , 19, TX, 76	1 ⁷ / ₁₆	2 ³¹ / ₃₂
TC 500	PTC 500	500	1, 20, TH, 87	1 ¹¹ / ₁₆	3 ¹⁷ / ₃₂
TC 600	PTC 600	600	1 (1/8)-1, 22, 96	2 ¹ / ₁₆	4 ⁷ / ₃₂
TC 750	PTC 750	750	1 ⁵ / ₁₆ , 24, 106	2 ¹ / ₁₆	4 ⁷ / ₃₂
TC 800	PTC 800	800	1 ⁵ / ₁₆ , 2, 25	2 ¹ / ₁₆	4 ⁷ / ₃₂
TC 1000	PTC 1000	1,000	1 ¹ / ₂ , 27, 125	2 ¹ / ₄	5
TC 1500	PTC 1500	1,500	1 ³ / ₄ , 31, 150	2 ³ / ₄	6
TC 2000	PTC 2000	2,000	2.00, 34, 175	3 ¹ / ₈	6 ³ / ₄

Diagrams

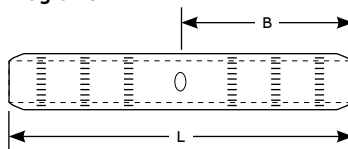

"TC" Dimple style

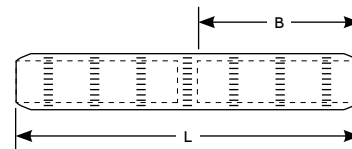

"PTC" Solid center oil stop

Copper tees

Tin-plated tees



250 T 250

Tees available in many run and tap sizes for various copper conductors

- High conductivity, resistant to corrosion
- Easy identification

Tin-plated tees

Cat. no.	Conductor size (AWG or kcmil)	
	Run	Tap
2 T 2	#2	#2
1/0 T 6	1/0	#6
1/0 T 4	1/0	#4
1/0 T 2	1/0	#2
1/0 T 1	1/0	#1
1/0 T 1/0	1/0	1/0
2/0 T 6	2/0	#6
2/0 T 4	2/0	#4
2/0 T 2	2/0	#2
2/0 T 1	2/0	#1
2/0 T 1/0	2/0	1/0
2/0 T 2/0	2/0	2/0
3/0 T 1/0	3/0	1/0
3/0 T 3/0	3/0	3/0
4/0 T 2	4/0	#2
4/0 T 1	4/0	#1
4/0 T 1/0	4/0	1/0
4/0 T 2/0	4/0	2/0
4/0 T 4/0	4/0	4/0
250 T 2	250	#2
250 T 1	250	#1
250 T 1/0	250	1/0
250 T 2/0	250	2/0
250 T 4/0	250	4/0
250 T 250	250	250
300 T 300	300	300

Cat. no.	Conductor size (AWG or kcmil)	
	Run	Tap
350 T 1/0	350	1/0
350 T 2/0	350	2/0
350 T 4/0	350	4/0
350 T 350	350	350
400 T 1/0	400	1/0
400 T 2/0	400	2/0
400 T 4/0	400	4/0
400 T 250	400	250
400 T 300	400	300
400 T 350	400	350
400 T 400	400	400
500 T 1/0	500	1/0
500 T 2/0	500	2/0
500 T 4/0	500	4/0
500 T 250	500	250
500 T 350	500	350
500 T 400	500	400
500 T 500	500	500
600 T 2/0	600	2/0
600 T 4/0	600	4/0
600 T 350	600	350
600 T 500	600	500
600 T 600	600	600
750 T 350	750	350
750 T 500	750	500
750 T 750	750	750
1000 T 500	1,000	500
1000 T 1000	1,000	1,000

Copper tees

Tin-plated tapered tees



TT 350-350

Tapered ends enable use in high-voltage applications up to 69 kV

- Provides high conductivity
- Resists corrosion

Tin-plated tapered tees

Cat. no.	Run	Tap	Dimensions (in.)	
			L	T
TT 2-2	#2	#2	3 ¹¹ / ₁₆	1½
TT 1/0-6	1/0	#6	3 ³ / ₁₆	1½
TT 1/0-4	1/0	#4	3 ¹³ / ₁₆	1½
TT 1/0-2	1/0	#2	3 ⁷ / ₈	1½
TT 1/0-1	1/0	#1	3 ¹⁵ / ₁₆	1½
TT 1/0-1/0	1/0	1/0	4	1½
TT 2/0-6	2/0	#6	3 ²⁹ / ₃₂	1½
TT 2/0-4	2/0	#4	3 ³¹ / ₃₂	1½
TT 2/0-2	2/0	#2	4 ¹ / ₃₂	1½
TT 2/0-1	2/0	#1	4 ³ / ₃₂	1½
TT 2/0-1/0	2/0	1/0	4 ⁵ / ₃₂	1½
TT 2/0-2/0	2/0	2/0	4 ⁵ / ₃₂	1½
TT 3/0-1/0	3/0	1/0	4 ⁷ / ₁₆	1 ⁵ / ₈
TT 3/0-3/0	3/0	3/0	4 ⁷ / ₁₆	1 ⁵ / ₈
TT 4/0-2	4/0	#2	4 ³ / ₁₆	1 ³ / ₄
TT 4/0-1	4/0	#1	4 ³ / ₁₆	1 ³ / ₄
TT 4/0-1/0	4/0	1/0	4 ¹ / ₄	1 ³ / ₄
TT 4/0-2/0	4/0	2/0	4 ⁵ / ₁₆	1 ³ / ₄
TT 4/0-4/0	4/0	4/0	4 ⁷ / ₁₆	1 ³ / ₄
TT 250-2	250	#2	4 ¹ / ₄	1 ³ / ₄
TT 250-1	250	#1	4 ¹ / ₄	1 ³ / ₄
TT 250-1/0	250	1/0	4 ⁵ / ₁₆	1 ³ / ₄
TT 250-2/0	250	2/0	4 ³ / ₈	1 ³ / ₄
TT 250-4/0	250	4/0	4 ¹ / ₂	1 ³ / ₄
TT 250-250	250	250	4 ³ / ₁₆	1 ³ / ₄
TT 300-300	300	300	4 ³ / ₁₆	1 ³ / ₄

Cat. no.	Run	Tap	Dimensions (in.)	
			L	T
TT 350-1/0	350	1/0	5 ³⁷ / ₆₄	2 ¹³ / ₁₆
TT 350-2/0	350	2/0	5 ³⁷ / ₆₄	2 ¹³ / ₁₆
TT 350-4/0	350	4/0	5 ²³ / ₃₂	2 ¹³ / ₁₆
TT 350-350	350	350	5 ²⁹ / ₃₂	2 ¹³ / ₁₆
TT 400-1/0	400	1/0	5 ²¹ / ₃₂	2 ³ / ₈
TT 400-2/0	400	2/0	5 ²¹ / ₃₂	2 ³ / ₈
TT 400-4/0	400	4/0	5 ²⁵ / ₃₂	2 ³ / ₈
TT 400-250	400	250	5 ²⁷ / ₃₂	2 ³ / ₈
TT 400-300	400	300	5 ²⁹ / ₃₂	2 ³ / ₈
TT 400-400	400	400	6 ¹ / ₃₂	2 ³ / ₈
TT 500-1/0	500	1/0	6 ²³ / ₆₄	2 ¹⁹ / ₃₂
TT 500-2/0	500	2/0	6 ²³ / ₆₄	2 ¹⁹ / ₃₂
TT 500-4/0	500	4/0	6 ¹⁵ / ₃₂	2 ¹⁹ / ₃₂
TT 500-250	500	250	6 ¹⁷ / ₃₂	2 ¹⁹ / ₃₂
TT 500-350	500	350	6 ²¹ / ₃₂	2 ¹⁹ / ₃₂
TT 500-400	500	400	6 ²³ / ₃₂	2 ¹⁹ / ₃₂
TT 500-500	500	500	6 ²³ / ₃₂	2 ¹⁹ / ₃₂
TT 600-2/0	600	2/0	7 ³ / ₁₆	3 ³ / ₃₂
TT 600-4/0	600	4/0	7 ⁷ / ₁₆	3 ³ / ₃₂
TT 600-350	600	350	7 ⁹ / ₁₆	3 ³ / ₃₂
TT 600-500	600	500	7 ¹¹ / ₁₆	3 ³ / ₃₂
TT 600-600	600	600	7 ⁷ / ₈	3 ³ / ₃₂
TT 750-350	750	350	9 ¹ / ₂	4 ¹ / ₄
TT 750-500	750	500	9 ¹ / ₂	4 ¹ / ₄
TT 750-750	750	750	9 ¹ / ₂	4 ¹ / ₄
TT 1000-500	1,000	500	9 ¹ / ₂	4 ¹ / ₄
TT 1000-1000	1,000	1,000	9 ¹ / ₂	4 ¹ / ₄

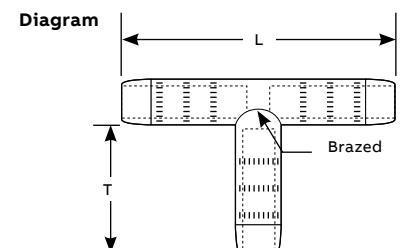

Copper tees



2131-20

- Provides high strength and high conductivity
- Resists corrosion

Cat. no.	Conductor size (AWG or kcmil)		Dimensions (in.)		
	Run	Tap	B	L	W
2131-1	750	2/0 str.	1½	4⅞	2½ ₁₆
2131-2	750	4/0 str.	1⅝	5	2½ ₁₆
2131-3	750	250	1⅝	5	2½ ₁₆
2131-4	750	350	2	5⅝	2½ ₁₆
2131-5	750	500	2¼	5⅝	2½ ₁₆
2131-6	750	750	2⅞	6¼	2½ ₁₆
2131-7	1,000	2/0 str.	1½	4⅞	2½ ₁₆
2131-8	1,000	4/0 str.	1⅝	5	2½ ₁₆
2131-9	1,000	250	1⅝	5	2½ ₁₆
2131-10	1,000	350	2	5⅝	2½ ₁₆
2131-11	1,000	500	2¼	5⅝	2½ ₁₆
2131-12	1,000	750	2⅞	6¼	2½ ₁₆
2131-13	1,000	1,000	3	6⅝	2½ ₁₆
2131-14	1,500	2/0 str.	1½	4⅞	2½ ₁₆
2131-15	1,500	4/0 str.	1⅝	5	2½ ₁₆
2131-16	1,500	250	1⅝	5	2½ ₁₆
2131-17	1,500	350	2	5⅝	2½ ₁₆
2131-18	1,500	500	2¼	5⅝	2½ ₁₆
2131-19	1,500	750	2⅞	6¼	2½ ₁₆
2131-20	1,500	1,000	3	6⅝	2½ ₁₆
2131-21	1,500	1,500	3¾ ₁₆	6⅞	2½ ₁₆
2131-22	1,500	2,000	3¾	8	2½

Diagram

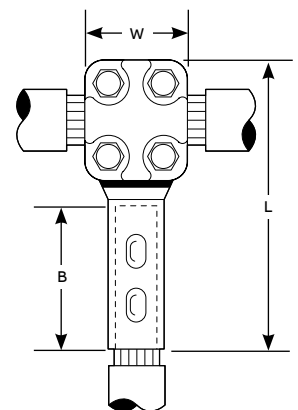

Aluminum and copper lug tee taps

NEMA lug tee taps for cable buses



NLTT 1000

NEMA lug tee taps for cable buses

Cat. no.	Main conductor	Figure number/Taps	Width (in.)
ANLTT 4/0	4/0	2	1½
ANLTT 350	350	2	1½
ANLTT 500	500	2	1½
ANLTT 750	750	2	1¾
ANLTT 1000	1,000	2	1¾
ANLTT 1500	1,500	2	2½
ANLT 4/0	4/0	1	1½
ANLT 350	350	1	1½
ANLT 500	500	1	1½
ANLT 750	750	1	1¾
ANLT 1000	1,000	1	1¾
ANLT 1500	1,500	1	2½

- Choose the taps that match your system
- Accommodate all sizes of standard NEMA drilled compression lugs
- Resists corrosion

Cat. no.	Main conductor	Figure number/Taps	Width (in.)
NLTT 4/0	4/0	2	1½
NLTT 350	350	2	1½
NLTT 500	500	2	1½
NLTT 750	750	2	1¾
NLTT 1000	1,000	2	1¾
NLTT 1500	1,500	2	2½
NLT 4/0	4/0	1	1½
NLT 350	350	1	1½
NLT 500	500	1	1½
NLT 750	750	1	1¾
NLT 1000	1,000	1	1¾
NLT 1500	1,500	1	2½

Diagrams

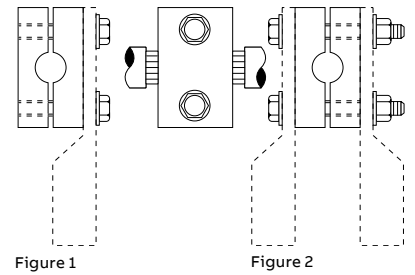

For sizes not listed, please consult your ABB representative.

Competitive cross reference

Type WR "O" and "D" – Die seven connector program					
Blackburn	Penn Union	Burndy	Homac	Kearney	Anderson
WR159	KO-R06	YHO100, YHO1	OB44	506-82	-
WR189	KO-R08	YHO150, YHO2	OB101	508-82	-
WR289	KD-R02	YHD200, YHD3	DB202	502-82	-
WR279	KD-R04	YHD300, YHD4	DB2020	504-82	-
WR379	KD-R03	YHD250, YHD5	DB404	503-82	-
WR399	KD-R05	YHD350, YHD6	DB4020	505-82	-
WR419	KD-R28	YHD400, YHD7	DB4040	507-82	-
Type WR – Supplemental "O" and "D" die seven connector program					
Blackburn	Penn Union	Burndy	Homac	Kearney	Anderson
WR149	KO-R33	YNO125	-	333-81	VCP44
WR179	KO-R08	YC25A2	-	325-81	-
WR199	KO-R08	YP26AU2	-	329-81	-
WR1010	-	YHO2-ONE	OB1010D	-	-
WR259	KD-R04	YC25A25	-	-	-
WR299	KD-R02	YHD200	-	-	-
WR219	KD-R26	-	-	326-81	-
WR239	-	-	-	-	-
WR229	KD-R30	-	-	-	-
WR269	KD-R27	-	-	-	-
WR319	-	-	-	-	-
WR339	KD-R96	-	-	-	-
WR359	KD-R49	-	-	349-81	-
WR369	KD-R94	-	-	394-81	-
WR389	KD-R95	-	-	395-8	-
Type WR – Wide range "N" die tap connectors for hydraulic tools, 12-ton and greater					
Blackburn	Penn Union	Burndy	Homac	Kearney	Anderson
WR715	KN-1	-	NB50040	-	-
WR775	-	YHN450	-	-	-
WR815	-	YHN500	-	-	-
WR835	KN-R2	-	-	-	-
WR875	-	-	-	-	-
WR885	-	YHN525	NB500	-	-
Type WR – Wide range "N" die tap connectors for hydraulic tools, 10-ton and greater					
Blackburn	Penn Union	Burndy	Homac	Kearney	Anderson
WR699	KN-0	-	-	480	-
WR719	-	-	-	481	-
WR739	KN-R2	YHN550	-	482-81	-
WR779	KN-4	YHN600	-	483	-
WR799	KN-R5	-	-	485-81	-
WR819	KN-R6	YC33R26	NB60020	486-81	NB60020
WR839	KN-R7	-	-	487-81	-
WR879	KN-8	-	-	488	-
WR889	-	-	-	-	-
Type WR – Wide range aluminum tap connectors "R" die seven connector program					
Blackburn	Penn Union	Burndy	Homac	Kearney	Anderson
WR909	KR-R03	YHR700	-	603-82	-
WR929	KR-R04	YHR750	ZB-954	604-82	-
WR949	KR-R05	YHR800	-	605-82	-
WR969	KR-R06	YHR850	ZB-954	606-82	-
WR989	KR-R07	YHR900	ZB-954	607-82	-
WR999	-	-	-	-	-

Competitive cross reference

Type WR – Street lighting compression connectors					
Blackburn	Penn Union	Burndy	Homac	Kearney	Anderson
WR9	KO-R22	YP2A9U	-	421-8	-
WR139	KO-R24	YPC26R8U	-	-	-
WR502	-	-	-	-	-
Type CF – Copper compression tap connectors					
Blackburn	Penn Union	Burndy	Homac	Kearney	Anderson
CF44-1	CDT-399-8	-	-	399-8	-
CF544-1	CDT-301	-	-	-	-
CF22-1	CDT-398-8	-	-	398-8	-
CF522-1	CDT-302	-	-	-	-
CF102-1	CDT-304-8	-	-	304-8	-
CF1010-1	CDT-303-8	-	-	303-8	-
CF202-1	-	-	-	-	-
CF2020-1	CDT-305-8	-	-	305-8	-
CF402-1	CDT-309-8	-	-	309-8	-
CF4010-1	CDT-308-8	-	-	308-8	-
CF4040-1	CDT-307-8	-	-	307-8	-
Type C – Compression connectors covers					
Blackburn	Penn Union	Burndy	Homac	Kearney	Anderson
C2BB	-	-	CO20B	48480	SEC-4
C5-BB	-	CCO	CO20B	6010	PTC-1
C7	-	CCD	CD40B	601D	PTC-2
C9	-	CCN	CN600B	-	-
C9L	-	CCNL	CN600B	-	-

Competitive cross reference

Compression connectors

Type CTL – Copper lugs, two-hole mount, short barrel						
Blackburn	Penn Union	Burndy	IlSCO	ABB	Anderson	
CTL6-214	-	YA6CL2TC14 , YA6C2L	-	54205	-	
CTL4-214	-	-	-	54206	-	
CTL2-2516	-	-	-	-	-	VHCS-2-516
CTL1-2516	-	-	-	54255	-	
CTL10-2516	-	YA1C-2L	-	54260	-	
CTL202	-	-	-	54265	-	
CTL302	-	-	-	54270	-	
CTL402	BLU-3/0D	YA27-2LN	CRA-4/0L2	54275	-	
CTL2502	BLU-4/0D	YA28-2LN	CRA-350L2	54280	-	
CTL3002	BLU-025D	YA29-2LN	CRA-300L2	54282	-	
CTL3502	BLU-030D	YA30-2LN	CRA-350L2	-	-	
CTL4002	BLU-035D	YA31-2LN	CRA-400L2	54286	-	VHCS-500-12BN,
CTL5002	BLU-040D	YA32-2LN	CRA-500L2	-	-	VHCS-500-12B
-	-	-	-	-	-	VHCS-600-38B
CTL6002-38	-	-	-	-	-	
CTL6002-12	-	-	-	-	-	
CTL7502	BLU-060D	-	CRA-750L2	54223	-	
CTL10002	-	-	CRA-1000L2	54223	-	
Type CTL – Copper lugs, one-hole mount, long barrel						
Blackburn	Penn Union	Burndy	IlSCO	ABB	Anderson	
CTL8L-14	-	-	-	54930BE	-	
CTL6L-14	BBLU-6S	CRB-6L	-	54905BE	-	
CTL4L-14	BBLU-4S	CRB-4L	-	54906BE	-	
CTL2L-516	BBLU-2S	-	-	54942BE	-	
CTL1L-516	BBLU-1S	CRA-1L	-	54947BE	-	
CTL10L-516	BBLU-1/0S	YA25	CRA-1/0L	-	-	
CTL20L-38	BBLU-2/0S	YA26	CRA-2/0L	54910BE	-	
CTL30L-12	BBLU-3/0S	YA27	CRB-3/0L	54965BE	-	
CTL40L-12	BBLU-4/0S	YA28	CRB-4/0B	54970BE	-	
CTL250L-12	BBLU-025S	-	CRA-250L	54913BE	-	
CTL300L-12	BBLU-030S	YA30	CRA-300L	54914BE	-	
CTL350L-12	BBLU-035S	YA31	CRA-350L	54915BE	-	
CTL400L-58	BBLU-040S	YA32	CRA-400L	-	-	
CTL500L-58	BBLU-050S	YA34	CRA-500L	-	-	
CTL600L-58	BBLU-060S	YA36	CRA-600L	54920BE	-	
CTL750L-58	BBLU-075S	YA39	CRA-750L	54923BE	-	
CTL1000L-58	BBLU-100S	YA44	CRA-1000L	54928BE	-	

Competitive cross reference

Type LCN – Copper lugs, two-hole mount, long barrel										
Blackburn	Penn Union	Burndy	IlSCO	ABB	Homac	Kearney	Anderson	Dossert	Panduit	3M
LCN8-14	-	-	-	54850BE	-	-	-	-	-	-
LCN6-14	BBLU-6D	YA6C-2TC14	CRB-6L2	54852BE	-	-	-	-	-	-
LCN6-12	-	YA6C-2N	-	-	-	-	-	-	-	-
LCN4-14	BBLU-4D	YA4C-2TC14	CRB-4L2	54854BE	-	-	-	-	-	-
LCN4-12	-	YA4C-2N	CRC-4L2	-	-	-	-	-	-	-
LCN2-516	BBLU-2D	-	CRB-2L2	54856BE	-	-	-	-	-	-
LCN2-12	-	YA2C-2N	CRC-2L2	-	-	-	-	-	-	-
LCN1-516	BBLU-1D	-	CRA-1L2	54858BE	-	-	-	-	-	-
LCN1-12	-	YA1C-2N	-	-	-	-	-	-	-	-
LCN10	BBLU-1/OD	YA25-2	CRA-1/0L2	54860BE	-	-	-	DPL10-2	-	-
LCN20	BBLU-2/OD	YA26-2N	CRA-2/0L2	54862BE	-	-	VHCL-2/0-12BN	DPL13-2N	-	-
LCN30	BBLU-3/OD	YA27-2N	CRB-3/0L2	54864BE	-	-	VHCL-3/0-12BN	DPL17-2N	-	-
LCN40	BBLU-4/OD	YA28-2N	CRA-4/0L2	54866BE	-	-	VHCL-4/0-12BN	DPL21-2N	-	31145
LCN250	BBLU-025D	YA29-2N	CRA-250L2	54868BE	-	-	VHCL-250-12BN	DPL25-2N	-	31149
LCN300	BBLU-030D	YA32-2N	-	-	-	-	-	-	-	-
LCN350	BBLU-035D	YA31-2N	CRA-350L2	54872BE	-	-	VHCL-350-12BN	DPL35-2N	-	31156
LCN400	BBLU-040D	-	-	-	-	-	-	-	-	-
LCN500	BBLU-050D	YA34-2N	CRA-500L2	54876BE	-	-	VHCL-500-12BN	DPL50-2N	-	31166
LCN600	BBLU-0600D	-	-	-	-	-	-	-	-	-
LCN75	BBLU-075D	-	-	-	-	-	-	-	-	-
LCN99	BBLU-100D	-	-	-	-	-	-	-	-	-
Type CU – Copper splices, long barrel										
Blackburn	Penn Union	Burndy	IlSCO	ABB	Homac	Kearney	Anderson	Dossert	Panduit	3M
CU8	-	YS8C	-	54804	-	-	-	-	-	-
CU6	BBCU-6	YS6C	LTL-6	54805	-	-	-	-	-	-
CU4	BBCU-4	YS4C	LTL-4	54806	-	-	-	-	-	-
CU2	BBCU-2	YS2C	LTL-2	54807	-	-	-	-	-	-
CU1	BBCU-1	YS1C	LTL-1	54809	-	-	-	-	-	-
CU10	BBCU-1/0	YS25	CTL-1/0	54809	C1/0	136700-010	VHS-1/0	DPC-10	SCL1/0	-
CU20	BBCU-2/0	YS26	CTL-2/0	54810	C2/0	136700-020	VHS-2/0	DPC-13	SCL2/0	11006
CU30	BBCU-3/0	YS27	CTL-3/0	54811	-	-	VHS-3/0	DPC-17	SCL3/0	11007
CU40	BBCU-4/0	YS28	CTL-4/0	54812	C4/0	136700-040	VHS-4/0	DPC-21	SCL4/0	11008
CU250	BBCU-025	YS29	CTL-250	54813	C250	136700-250	VHS-250	DPC-25	SCL250	11009
CU300	BBCU-030	YS30	-	-	-	-	-	-	-	-
CU350	BBCU-035	YS31	CTL-350	54815	C350	-	VHS-350	DPC-35	SCL350	11011
CU400	BBCU-040	YS32	-	-	-	-	-	-	-	-
CU500	BBCU-050	YS34	CTL-500	54818	C500	136700-500	VHS-500	DPC-50	SCL500	11014
CU600	BBCU-060	YS36	-	-	-	-	-	-	-	-
CU750	BBCU-075	YS39	CTL-750	54823	C750	136700-750	VHS-750	DPC-75	SCL750	11019
CU1000	BBCU-100	YS44	CTL-1000	54828	C1000	136700-1000	VHS-1000	DPC-100	SCL1000	11024

Competitive cross reference

Type CSP – Copper splices, short barrel										
Blackburn	Penn Union	Burndy	IlSCO	ABB	Homac	Kearney	Anderson	Dossert	Panduit	3M
CSP8	BCU-8	–	CT-8	54504	–	–	–	–	SCS8	–
CSP6	BCU-6	YS6C-L	CT-6	54505	–	–	VHSS-6	DPCS-2	SCS6	10001
CSP4	BCU-4	YS4C-L	CT-4	54506	–	–	VHSS-4	DPCS-4	SCS4	10002
CSP2	BCU-2	YS2C-L	CT-2	54507	–	–	VHSS-2	DPCS-6	SCS2	10003
CSP1	BCU-1	YS1C-L	CT-1	54508	–	–	VHSS-1	DPCS-8	SCS1	10004
CSP10	BCU-1/0	YS25-L	CT-1/0	54509	–	–	VHSS-1/0	DPCS-10	SCS1/0	10005
CSP20	BCU-2/0	YS26-L	CT-2/0	54510	–	–	VHSS-2/0	DPCS-13	SCS2/0	10006
CSP30	BCU-3/0	YS27-L	CT-3/0	54511	–	–	VHSS-3/0	DPCS-17	SCS3/0	10007
CSP40	BCU-4/0	YS28-L	CT-4/0	54512	–	–	VHSS-4/0	DPCS-21	SCS4/0	10008
CSP250	BCU-025	YS29-L	CT-250	54513	–	–	VHSS-250	DPCS-25	SCS250	10009
CSP300	BCU-030	YS30-L	CT-300	54514	–	–	VHSS-300	DPCS-30	SCS300	10010
CSP350	BCU-035	YS31-L	CT-350	54515	–	–	VHSS-350	DPCS-35	SCS350	10011
CSP400	BCU-040	YS32-L	CT-400	54516	–	–	VHSS-400	DPCS-40	SCS400	–
CSP500	BCU-050	YS34-L	CT-500	54518	–	–	VHSS-500	DPCS-50	SCS500	10014
CSP600	–	–	–	–	–	–	–	–	–	–
CSP750	BCU-075	YS39-L	CT-750	54523	–	–	VHSS-750	DPCS-75	SCS750	10019
CSP1000	BCU-100	YS44-L	CT-1000	54528	–	–	VHSS-1000	DPCS-100	SCS1000	10024

Competitive cross reference

Type ATL – Aluminum lugs, one-hole										
Blackburn	Penn Union	Burndy	IlSCO	ABB	Homac	Kearney	Anderson	Dossert	Panduit	3M
ATL8-10	-	YA8CA1	ACN-8	60101	-	-	VACL-8-10	-	-	-
ATL8-14	BLUA-8S	YA8C-A3	ACL-8	60102	-	-	VACL-8-14	DPL-1-1-AA	-	-
ATL6-10	-	-	-	60106	-	-	VACL-6-10	-	-	-
ATL6-14	BLUA-6S	YA6C-A1	ACL-6	60107	-	-	VACL-6-14	DPL2-1-AA	LAA46-14	-
ATL6-38	-	-	-	-	-	-	-	-	-	-
ATL4-14	BLUA-4S3	YA4C-A1	ACL-4	60112	-	-	VACL-4-14	-	LAA4-14	-
ATL4-516	BLUA-4S2	YA4C-A3	ACN-4	60113	-	-	VACL-4-516	DPL-4-1-AA	LAA4-56	40020
ATL4-38	-	YA4CA6	-	-	-	-	VACL-4-38	-	LAA4-38	-
ATL2-14	BLUA-2S3	-	ACL-2	60116	-	-	VACL-2-14	-	LAA2-14	-
ATL2-516	BLUA-2S4	YA2C-A1	ACN-2	60117	-	-	VACL-2-516	-	LAA2-56	-
ATL2-38	BLUA-2S	YA2C-A3	-	60118	-	-	VACL-2-38	DPL-6-1-AA	LAA2-38	40024
ATL1-516	BLUA-1S3	-	-	60123	-	-	-	-	LAA1-56	-
ATL1-38	BLUA-1S	YA1C-A1	-	60124	-	-	VACL-1-38	DPL-8-1-AA	LAA1-38	40028
ATL10-516	BLUA-1/0S3	YA25-A1	ACN-1/0	60129	-	-	VACL-1/0-516	-	LAA1/0-56	-
ATL10-38	BLUA-1/0S	YA25-A3	ACL-1/0	60130	-	-	VACL-1/0-38	DPL-10-1-AA	LAA1/0-38	40032
ATL10-12	-	-	-	-	-	-	-	-	-	-
ATL20-38	BLUA-2/0S6	YA26-A6	ACL-2/0	60136	-	-	VACL-2/0-38	-	LAA2/0-38	-
ATL20-12	BLUA-2/0S	YA26-A1	ACN-2/0	60138	-	-	VACL-2/0-12	DPL-13-1-AA	LAA2/0-12	40037
ATL30-38	BLUA-3/0S2	YA27-A1	ACL-3/0	60142	-	-	VACL-3/0-38	-	LAA3/0-38	-
ATL30-12	BLUA-3/0S	YA27A3	ACN-3/0	60144	-	-	VACL-3/0-12	DPL-17-1-AA	LAA3/0-12	40041
ATL40-38	BLUA-4/0S2	YA28-A1	ACL-4/0	60148	-	-	VACL-4/0-38	-	LAA4/0-38	-
ATL40-12	BLUA-4/0S	YA28-A3	-	60150	-	-	VACL-4/0-12	DPL-21-1-AA	LAA4/0-12	40045
ATL250-12	BLUA-025S	YA29-A1	ACL-250	60156	-	-	VACL-250-12	-	LAA250-12	40049
ATL300-38	-	-	-	-	-	-	-	-	-	-
ATL300-12	-	-	-	-	-	-	-	-	-	-
ATL350-12	BLUA-035S	YA31A1	ACL-350	60166	-	-	VACL-350-12	-	LAA350-12	40056
ATL400-58	-	-	-	-	-	-	-	-	-	-
ATL500-12	BLUA-050S2	YA34A1	ACL-500	60171	-	-	VACL-500-12	-	LAA500-12	-
ATL500-58	-	-	-	-	-	-	-	-	-	-
ATL600-12	-	-	-	-	-	-	-	-	-	-
ATL750-12	-	-	-	-	-	-	-	-	-	-
ATL750-58	BLUA-075S1	YA39A3	ACL-750	60178	-	-	VACL-750-58	-	LAA750-58	40073
Type ATL – Aluminum lugs, two-hole										
Blackburn	Penn Union	Burndy	IlSCO	ABB	-	-	Anderson	Dossert	Panduit	3M
ATL102-38	BLUA-1/0D1	YA25A5	2ACL-1/0	60230	-	-	VACL-1/0-38B	-	LAB1/0-38	40132
ATL102	-	-	-	-	-	-	-	-	-	-
ATL202	BLUA-2/0D	YA26-A3	2ACL-2/0	60238	-	-	VACL-2/0-12BN	DPL-13-2N-AA	LAB2/0-12	40137
ATL302	BLUA-3/0D	YA27A5	2ACL-3/0	60244	-	-	VACL-3/0-12BN	DPL-17-2N-AA	LAB3/0-12	40141
ATL402	BLUA-4/0D	YA28-A5	2ACL-4/0	60250	-	-	VACL-4/0-12VN	DPL-21-2N-AA	LAB4/0-12	40145
ATL2502	BLUA-025D	YA29-A3	2ACL-250	60256	-	-	VACL-250-12BN	DPL-25-2N-AA	LAB250-12	-
ATL3002	-	-	-	-	-	-	-	-	-	-
ATL3502	BLUA-035D	YA31-A1	2ACL-350	60267	-	-	VACL-350-12BN	DPL-35-2N-AA	LAB350-12	40156
ATL4002	-	-	-	-	-	-	-	-	-	-
ATL5002	BLUA-050D2	YA34A3	2ACL-750	60273	-	-	VACL-500-12BN	DPL-50-2N-AA	LAB500-12	40166
ATL6002	-	-	-	-	-	-	-	-	-	-
ATL7502	BLUA-075D1	YA39-A5	2ACL-750	60278	-	-	VACL-750-12BN	DPL-75-2N-AA	LAB750-12	40172

Conductor reference

Conductor diameter (in.)	ACSR or all aluminum	Rated breaking strength	Aluminum alloy (5005-6201)	Rated breaking strength	Compacted ACSR or all aluminum	Rated breaking strength	AWAC	Rated breaking strength	Copper or copperweld copper composite	Rated breaking strength
Bare conductor information AWG or kmcil										
0.162	#6, Solid	474.0	-	-	-	-	-	-	#6, Solid	1,280
0.169	-	-	-	-	#6, 7W	528	-	-	-	-
0.174	-	-	-	-	-	-	-	-	91 ^{1/4} 2D	1,743
0.179	-	-	-	-	-	-	-	-	8C	1,362
0.182	#5, Solid	597.7	-	-	#6, 6/1	1,170	-	-	#5, Solid	1,591
0.184	#6, 7W	560	-	-	-	-	-	-	#6, 7W	1,229
0.198	#6, 6/1	1,170	#6, 7W	555	-	-	-	-	-	-
0.199	-	-	-	-	-	-	-	-	8A	2,233
0.201	-	-	#6, 3W	915	-	-	-	-	-	-
0.202	-	-	-	-	-	-	-	-	#6, 3W	1,204
0.204	#4, Solid	-	-	-	-	-	-	-	#4, Solid	1,970
0.206	-	753.9	-	-	-	-	-	-	#5, 7W	1,542
0.213	-	-	-	-	#4, 7W	826	-	-	-	-
0.219	-	-	-	-	-	-	-	-	8D	3,256
0.223	#5, 6/1	1,460	-	-	-	-	-	-	7A	2,754
0.225	-	-	-	-	-	-	-	-	6C	2,143
0.226	-	-	-	-	-	-	-	-	#5, 3W	1,516
0.229	#3, Solid	929.9	-	-	#4, 6/1	1,830	-	-	#3, Solid	2,439
0.230	-	-	-	-	-	-	-	-	6A	2,585
0.232	#4, 7W	915	-	-	-	-	-	-	#4, 7W	1,938
0.236	-	-	-	-	#4, 7/1	2,288	-	-	-	-
0.245	-	-	-	-	-	-	#4, 6/1	1,783	-	-
0.246	-	-	-	-	-	-	-	-	7D	4,022
0.250	#4, 6/1	1,830	#4, 7W	875	-	-	-	-	-	-
0.257	#4, 7/1	2,290	-	-	-	-	-	-	-	-
0.258	#2, Solid	1,172.6	-	-	#3, 6/1	2,250	-	-	#2, Solid; 5A	3,003; 3,193
0.260	#3, 7W	1,100	-	-	-	-	-	-	#3, 7W	2,433
0.261	-	-	-	-	-	-	#4, 5/2	2,830	-	-
0.268	-	-	-	-	#2, 7W	1,266	-	-	-	-
0.276	-	-	-	-	-	-	-	-	6D	4,942
0.281	#3, 6/1	2,250	-	-	-	-	#4, 4/3	4,305	-	-
0.286	-	-	-	-	-	-	-	-	#3, 3W	2,359
0.289	-	-	-	-	-	-	-	-	#1, Solid	3,688
0.290	-	-	-	-	#2, 6/1	2,790	-	-	4A	3,938
0.292	#2, 7W	1,340	-	-	-	-	-	-	#2, 7W	3,045
0.298	-	-	-	-	#2, 7/1	3,525	-	-	-	-
0.301	-	-	-	-	#1, 7W	1,537	-	-	-	-
0.307	-	-	-	-	-	-	#4, 3/4	6,325	-	-
0.308	-	-	-	-	-	-	-	-	2F	4,233
0.309	-	-	-	-	-	-	#2, 6/1	2,760	-	-
0.310	-	-	-	-	-	-	-	-	5D	6,035
0.316	#2, 6/1	2,790	32,7W	2,195	-	-	-	-	-	-
0.320	-	-	-	-	-	-	-	-	#2, 3W	2,913
0.325	#2, 7/1	3,525	-	-	-	-	-	-	1/0, Solid	4,517
0.326	-	-	-	-	#1, 6/1	3,480	-	-	5P	9,311
0.327	-	-	-	-	-	-	-	-	2G	5,626
0.328	#1, 7W	1,620	-	-	-	-	-	-	#1, 7W; 4N	3,804; 8,460

Conductor reference

Conductor diameter (in.)	ACSR or all aluminum	Rated breaking strength	Aluminum alloy (5005-6201)	Rated breaking strength	Compacted ACSR or all aluminum	Rated breaking strength	AWAC	Rated breaking strength	Copper or copperweld copper composite	Rated breaking strength
Bare conductor information AWG or kmcil (cont'd)										
0.330	-	-	-	-	-	-	#2, 5/2	4,436	-	-
0.332	#1, 19W	1,685	-	-	-	-	-	-	#1, 19W	3,899
0.338	-	-	-	-	1/0, 7W	1,865	-	-	-	-
0.340	-	-	-	-	1/0, 19W	2,090	#4, 2/5	9,314	-	-
0.346	-	-	-	-	-	-	-	-	1F	5,266
0.348	-	-	-	-	-	-	-	-	4D	7,340
0.349	-	-	-	-	-	-	-	-	2J	7,322
0.355	#1, 6/1	3,480	-	-	-	-	#2, 4/3	6,785	-	-
0.360	-	-	-	-	-	-	-	-	#1, 3W	3,620
0.365	-	-	-	-	1/0, 6/1	4,280	-	-	2/0, Solid	5,519
0.366	-	-	-	-	-	-	-	-	2A; 4P	5,876; 11,420
0.367	80, 8/1	5,200	-	-	-	-	-	-	1G	6,956
0.368	1/0, 7W	1,970	-	-	-	-	-	-	1/0, 7W; 3N	4,750; 10,390
0.372	-	-	-	-	-	-	-	-	1/0, 19W	4,901
0.373	1/0, 19W	2,090	-	-	-	-	-	-	-	9,730
0.377	-	-	-	-	-	-	-	-	2K	-
0.381	-	-	-	-	2/0, 7W	2,350	-	-	-	-
0.382	-	-	-	-	2/0, 19W	2,586	-	-	-	-
0.386	-	-	-	-	-	-	#2, 3/4	9,793	-	-
0.388	-	-	-	-	-	-	-	-	1/0F	6,536
0.390	-	-	-	-	-	-	1/0, 6/1	4,246	1/0, 12W	4,841
0.392	-	-	-	-	-	-	-	-	1J	9,000
0.398	1/0, 6/1	4,280	1/0, 7W	3,405	-	-	-	-	-	-
0.410	-	-	-	-	2/0, 6/1	5,345	-	-	-	-
0.411	-	-	-	-	-	-	-	-	3P	13,910
0.412	-	-	-	-	-	-	-	-	1/0G	8,563
0.413	-	-	-	-	-	-	-	-	2N	12,680
0.414	2/0, 7W	2,485	-	-	-	-	-	-	2/0, 7W	5,927
0.416	-	-	-	-	-	-	1/0, 5/2	6,712	-	-
0.419	2/0, 19W	2,586	-	-	-	-	-	-	2/0, 19W	6,152
0.423	-	-	-	-	-	-	-	-	1K	11,900
0.426	-	-	-	-	3/0, 7W	2,845	-	-	-	-
0.428	-	-	-	-	3/0, 19W	3,200	-	-	-	-
0.429	-	-	-	-	-	-	-	-	-	-
0.436	-	-	-	-	-	-	-	-	2/0F	8,094
0.438	-	-	-	-	-	-	#2, 2/5	14,060	2/0, 12W	6,048
0.440	-	-	-	-	-	-	-	-	1/0J	10,970
0.447	2/0, 6/1	5,345	2/0, 7W	4,230	-	-	1/0, 4/3	10,020	-	-
0.461	101.8, 12/7	9,860	-	-	3/0, 6/1	6,675	-	-	-	-
0.462	-	-	-	-	-	-	-	-	2P	16,870
0.463	-	-	-	-	-	-	-	-	2/0G	10,510
0.464	3/0, 7W	3,005	-	-	-	-	-	-	3/0, 7W; IN	7,366; 15,410
0.467	-	-	-	-	-	-	2/0, 5/2	8,040	-	-
0.470	3/0, 19W	3,200	-	-	-	-	-	-	3/0, 19W	7,698
0.475	-	-	-	-	-	-	-	-	1/0K	14,490
0.480	-	-	-	-	4/0, 7W	3,590	-	-	-	-
0.481	110.8, 12/7	10,730	-	-	4/0, 19W	3,890	-	-	-	-
0.487	-	-	-	-	-	-	1/0, 3/4	14,006	-	-

Conductor reference

Circular mils Typical	AWG size	Metric wire size mm ²	Equivalent circular mils	Stranding/wire diameter per standard		Approximate overall diameter	
				in.	mm	in.	mm
AWG/kcmil vs. metric wire sizes — option 1							
—	—	0.50	987	1/0.032	1/0.813	0.032	0.81
1,020	20	—	—	7/0.0121	7/0.307	0.036	0.91
—	—	0.75	1,480	1/0.039	1/0.991	0.039	0.99
1,620	18	—	—	1/0.0403	1/1.02	0.040	1.02
1,620	18	—	—	7/0.0152	7/0.386	0.046	1.16
—	—	1.0	1,974	1/0.045	1/1.14	0.045	1.14
—	—	1.0	1,974	7/0.017	7/0.432	0.051	1.30
2,580	16	—	—	1/0.0508	1/1.29	0.051	1.29
2,580	16	—	—	7/0.0192	7/0.488	0.058	.46
—	—	1.5	2,960	1/0.055	1/1.40	0.055	1.40
—	—	1.5	2,960	7/0.021	7/5.33	0.063	1.60
4,110	14	—	—	1/0.0641	1/1.63	0.064	1.63
4,110	14	—	—	7/0.0242	7/0.615	0.073	1.84
—	—	2.5	4,934	1/0.071	1/1.80	0.071	1.80
—	—	2.5	4,934	7/0.027	7/0.686	0.081	2.03
6,530	12	—	—	1/0.0808	1/2.05	0.081	2.05
6,530	12	—	—	7/0.0305	7/0.775	0.092	2.32
—	—	4	7,894	1/0.089	1/2.26	0.089	2.26
—	—	4	7,894	7/0.34	7/0.864	0.102	2.59
10,380	10	—	—	1/0.1019	1/2.59	0.102	2.59
10,380	10	—	—	7/0.0385	7/0.978	0.116	2.93
—	—	6	11,840	1/0.109	1/2.77	0.109	2.77
—	—	6	11,840	7/0.042	7/0.107	0.126	3.21
13,090	9	—	—	1/0.1144	1/2.91	0.1144	2.91
13,090	9	—	—	7/0.0432	7/1.10	0.130	3.30
16,510	8	—	—	1/0.1285	1/3.26	0.128	3.26
16,510	8	—	—	7/0.0486	7/1.23	0.149	3.0
—	—	10	19,740	1/0.141	1/3.58	0.141	3.58
—	—	10	19,740	7/0.54	7/1.37	0.162	4.12
20,820	7	—	—	1/0.1443	1/3.67	0.144	3.67
20,820	7	—	—	7/0.545	7/1.38	0.164	4.15
26,240	6	—	—	1/0.162	1/4.11	0.162	4.11
26,240	6	—	—	7/0.0612	7/1.55	0.184	4.66
—	—	16	31,580	7/0.068	7/1.73	0.204	5.18
33,090	5	—	—	7/0.0688	7/1.75	0.206	5.24
41,740	4	—	—	7/0.0772	7/1.96	0.232	5.88
—	—	25	49,340	7/0.085	7/2.16	0.255	6.48
—	—	25	49,340	19/0.052	19/1.32	0.260	6.60
52,620	3	—	—	7/0.0867	7/2.20	0.260	6.61
66,360	2	—	—	7/0.0974	7/2.47	0.292	7.42
—	—	35	69,070	7/0.100	7/2.54	0.300	7.62
—	—	35	69,070	19/0.061	19/1.55	0.305	7.75

Conductor reference

Circular mils Typical	AWG size	Metric wire size mm ²	Equivalent circular mils	Stranding/wire diameter per standard		Approximate overall diameter	
				in.	mm	in.	mm
AWG/kcmil vs. metric wire sizes – option 1 (cont'd)							
83,690	1	–	–	19/0.0664	19/1.69	0.332	8.43
–	–	50	98,680	19/0.073	19/1.85	0.365	9.27
105,600	1/0	–	–	19/0.0745	19/1.89	0.373	9.46
133,100	2/0	–	–	19/0.0837	19/2.13	0.419	10.6
–	–	70	138,100	19/0.086	19/2.18	0.430	10.9
167,800	3/0	–	–	19/0.094	19/2.39	0.470	11.9
167,800	3/0	–	–	37/0.0673	37/1.71	0.471	12.0
–	–	95	187,500	19/0.101	19/2.57	0.505	12.8
–	–	95	187,500	37/0.072	37/1.83	0.504	12.8
211,600	4/0	–	–	19/0.1055	19/2.68	0.528	13.4
–	–	120	237.8 kcmil	37/0.081	37/2.06	0.567	14.4
250 kcmil	–	–	–	37/0.0822	37/2.09	0.575	14.6
300 kcmil	–	150	–	37/0.090	37/2.29	0.630	16.0
350 kcmil	–	–	–	37/0.0973	37/2.47	0.681	17.3
–	–	185	365.1 kcmil	37/0.100	37/2.54	0.700	17.8
400 kcmil	–	–	–	37/0.104	37/2.64	0.728	28.5
–	–	240	473.6 kcmil	37/0.114	37/2.90	0.798	20.3
–	–	240	473.6 kcmil	61/0.089	61/2.26	0.801	20.3
500 kcmil	–	–	–	37/0.1162	37/2.95	0.813	20.7
500 kcmil	–	–	–	61/0.0905	61/2.30	0.814	20.7
–	–	300	592.1 kcmil	61/0.99	61/2.51	0.891	22.6
600 kcmil	–	–	–	61/0.0992	61/2.52	0.893	22.7
700 kcmil	–	–	–	61/0.1071	61/2.72	0.964	24.5
750 kcmil	–	–	–	61/0.1109	61/2.82	0.998	25.4
750 kcmil	–	–	–	91/0.0908	91/2.31	0.999	25.4
–	–	400	789.4 kcmil	61/0.114	61/2.90	1.026	26.1
800 kcmil	–	–	–	61/0.1145	61/2.91	1.031	26.2
800 kcmil	–	–	–	91/0.0938	91/2.38	1.032	26.2
1,000 kcmil	–	500	986.8 kcmil	61/0.1280	61/3.25	1.152	29.3
1,000 kcmil	–	–	–	91/0.1048	91/2.66	1.153	29.3
–	–	625	1,233.7 kcmil	91/0.117	91/2.97	1.287	32.7
1,250 kcmil	–	–	–	91/0.1172	91/2.98	1.289	32.7
1,250 kcmil	–	–	–	127/0.0992	127/2.52	1.290	32.8
1,500 kcmil	–	–	–	91/0.1284	91/3.26	1.412	35.9
1,500 kcmil	–	–	–	127/0.1087	127/2.76	1.413	35.9
–	–	800	1,578.8 kcmil	91/0.132	91/3.35	1.452	36.9
–	–	1,000	1,973.5 kcmil	91/0.147	91/3.73	1.617	41.1
2,000 kcmil	–	–	–	127/0.1255	127/3.19	1.632	41.5
2,000 kcmil	–	–	–	169/0.1088	169/2.76	1.632	41.5

Conductor reference

Approximate overall diameter		Circular mils	AWG size	Metric wire size mm ²	Equivalent circular mils	Stranding/wire diameter per strand	
in.	mm					in.	mm
AWG/kcmil vs. metric wire sizes – option 2							
0.032	0.81	–	–	0.50	987	1/0.032	1/0.813
0.036	0.91	1,020	20	–	–	7/0.0121	7/0.307
0.039	0.999	1,020	–	0.75	1,480	1/0.039	1/0.991
0.040	1.02	1,620	18	–	–	1/0.0403	1/1.02
0.046	1.16	1,620	18	–	–	7/0.0152	7/0.386
0.045	1.14	–	–	1.0	1,974	1/0.045	1/1.14
0.051	1.30	–	–	1.0	1,974	7/0.017	7/0.432
0.051	1.29	2,580	16	–	–	1/0.0508	1/1.29
0.058	1.46	2,580	16	–	–	7/0.0192	7/0.488
0.055	0.40	–	–	1.5	2,960	1/0.055	1/1.40
0.063	1.60	–	–	1.5	2,960	7/0.021	7/5.33
0.064	1.63	4,110	14	–	–	1/0.0641	1/1.63
0.073	1.84	4,110	14	–	–	7/0.0242	7/0.615
0.071	1.80	–	–	2.5	4,934	1/0.071	1/1.80
0.081	2.06	–	–	2.5	4,934	7/0.027	7/0.686
0.081	2.05	6,530	12	–	–	1/0.0808	1/2.05
0.092	2.32	6,530	12	–	–	7/0.0305	7/0.775
0.089	2.26	–	–	4	7,894	1/0.089	1/2.26
0.102	2.59	–	–	4	7,894	7/0.034	7/0.864
0.102	2.59	10,380	10	–	–	1/0.1019	1/2.59
0.116	2.93	10,380	10	–	–	7/0.0385	7/0.978
0.109	2.77	–	–	6	11,840	1/0.109	1/2.77
0.126	3.21	–	–	6	11,840	7/0.042	7/0.107
0.1144	2.91	13,090	9	–	–	1/0.1144	1/2.91
0.130	3.30	13,090	9	–	–	7/0.0432	7/1.10
0.128	3.26	16,510	8	–	–	1/0.1285	1/3.26
0.146	3.70	16,510	8	–	–	7/0.0486	7/1.23
0.141	3.58	–	–	10	19,740	1/0.141	1/3.58
0.162	4.12	–	–	10	19,740	7/0.054	7/1.37
0.144	3.67	20,820	7	–	–	1/0.1443	1/3.67
0.164	4.15	20,820	7	–	–	7/0.0545	7/1.38
0.162	4.11	26,240	6	–	–	1/0.162	1/4.11
0.184	4.66	26,240	6	–	–	7/0.0612	7/1.55
0.204	5.18	–	–	16	31,580	7/0.068	7/1.73
0.206	5.24	33,090	5	–	–	7/0.0688	7/1.75
0.232	5.88	41,740	4	–	–	7/0.0772	7/1.96
0.255	6.48	–	–	25	49,340	7/0.085	7/2.16
0.260	6.60	–	–	25	49,340	19/0.052	19/1.32
0.260	6.61	52,620	3	–	–	7/0.0867	7/2.20
0.292	7.42	66,360	2	–	–	7/0.0974	7/2.47
0.300	7.62	–	–	35	69,070	7/0.100	7/2.54
0.305	7.75	–	–	35	69,070	19/0.061	19/1.55

Conductor reference

Approximate overall diameter		Circular mils	AWG size	Metric wire size mm ²	Equivalent circular mils	Stranding/wire diameter per strand	
in.	mm					in.	mm
AWG/kcmil vs. metric wire sizes – option 2 (cont'd)							
0.332	8.43	83,690	1	–	–	19/0.0664	19/1.69
0.365	9.27	–	–	50	98,680	19/0.073	19/1.85
0.373	9.46	105,600	1/0	–	–	19/0.0745	19/1.89
0.419	10.6	133,100	2/0	–	–	19/0.0837	19/2.13
0.430	10.9	–	–	70	138,100	19/0.086	19/2.18
0.470	11.9	167,800	3/0	–	–	19/0.094	19/2.39
0.471	12.0	167,800	3/0	–	–	37/0.0673	37/1.71
0.505	12.8	–	–	95	187,500	19/0.101	19/2.57
0.504	12.8	–	–	95	187,500	37/0.072	37/1.83
0.528	13.4	211,600	4/0	–	–	19/0.1055	19/2.68
0.567	14.4	–	–	120	237.8 kcmil	37/0.081	37/2.06
0.575	14.6	250 kcmil	–	–	–	37/0.0822	37/2.09
0.630	16.0	300 kcmil	–	150	–	37/0.090	37/2.29
0.681	17.3	350 kcmil	–	–	–	37/0.0973	37/2.47
0.700	17.8	–	–	185	365.1 kcmil	37/0.100	37/2.54
0.728	18.5	400 kcmil	–	–	–	37/0.104	37/2.64
0.798	20.3	–	–	240	473.6 kcmil	37/0.114	37/2.90
0.801	20.3	–	–	240	473.6 kcmil	61/0.089	61/2.26
0.813	20.7	500 kcmil	–	–	–	37/0.1162	37/2.95
0.814	20.7	500 kcmil	–	–	–	61/0.0905	61/2.30
0.891	22.6	–	–	300	592.1 kcmil	61/0.099	61/2.51
0.893	22.7	600 kcmil	–	–	–	61/0.0992	61/2.52
0.964	24.5	700 kcmil	–	–	–	61/0.1071	61/2.72
0.998	25.4	750 kcmil	–	–	–	61/0.1109	61/2.82
0.999	25.4	750 kcmil	–	–	–	91/0.0908	91/2.31
1.026	26.1	–	–	400	789.4 kcmil	61/0.114	61/2.90
0.031	26.2	800 kcmil	–	–	–	61/0.1145	61/2.91
0.032	26.2	800 kcmil	–	–	–	91/0.0938	91/2.38
1.152	29.3	1,000 kcmil	–	500	986.8 kcmil	61/0.1280	61/3.25
0.153	29.3	1,000 kcmil	–	–	–	91/0.1048	91/2.66
1.287	32.7	–	–	625	1,233.7 kcmil	91/0.117	91/2.97
1.289	32.7	1,250 kcmil	–	–	–	91/0.1172	91/2.98
1.290	32.8	1,250 kcmil	–	–	–	127/0.0992	127/2.52
1.412	35.9	1,500 kcmil	–	–	–	91/0.1284	91/3.26
1.413	35.9	1,500 kcmil	–	–	–	127/0.1087	127/2.76
1.452	36.9	–	–	800	1,578.8 kcmil	91/0.132	91/3.35
1.617	41.1	–	–	1,000	1,973.5 kcmil	91/0.147	91/3.73
1.632	41.5	2,000 kcmil	–	–	–	127/0.1255	127/3.19
1.632	41.5	2,000 kcmil	–	–	–	169/0.1088	169/2.76