

## Threaded products and hardware

### Channel nuts

Superstrut channel nuts are manufactured from grade 2 mild steel and are case hardened.

### Design data

Superstrut self-aligning channel nuts are designed to provide resistance to pullout and resistance to side slip in excess of the full strength of the channels with which they are used. The extreme resistance to side slip results from the unique design of the alternate teeth, spaced and designed to develop a wedging action that increases with pressure or load.

### Screw threads

All threaded products are American Standard thread, free fit class 2.

Thread size (in.)	¼	⅜	½	¾	1
Threads per inch	20	18	16	13	11
Design torque (ft.-lb)	6	11	19	50	100

### Finish and special materials

Standard finish for all hardware is electrogalvanized (EGC) or GoldGalv®. Stainless steel type 316 is also available. Contact your regional sales office for availability and minimum quantities.

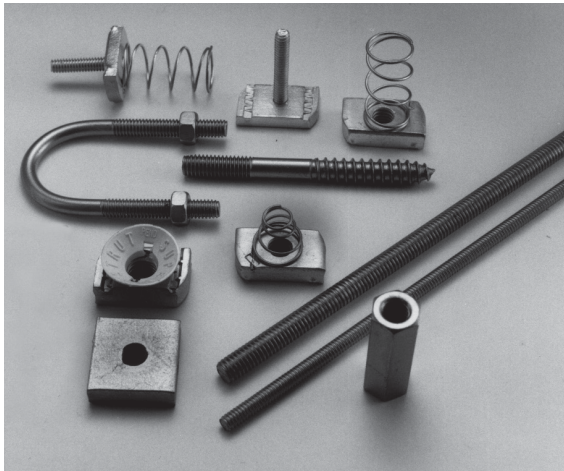

### Spring nut selector chart

Spring nut	Channel series					
	A-AR	B-BR	C	D	E	H
A100-1/4EGC						
A100-5/16EGC						
A100-3/8EGC						
A100-1/2EGC						
A100-3/4						
B100-1/4EGC						
B100-5/16EGC						
B100-3/8EGC						
B100-1/2EGC						
H100-3/8EGC						
H100-1/2EGC						
CM100-1/4						
CM100-3/8						
CM100-1/2						
CM100-1/2B						
UC100-1/4						
UC100-3/8						
UC100-1/2						

## Threaded products and hardware

### A100 Regular spring nut\*

Std. pack 100

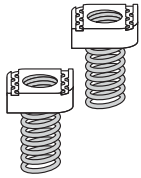

	Cat. No.	Size (in.)	Wt./C lb
	A100-1/4EGC	1/4	8
	A100-5/16EGC	5/16	9
	A100-3/8EGC	3/8	10
	A100-1/2EGC	1/2	12
	A100-5/8EGC	5/8	19
	A100-3/4	3/4	19
	A100-7/8	7/8	18

Available in stainless steel 316. Nut is square over 1/2 in. size.  
For all A and C series channel and inserts.

### AB100 Springless nut 1/4 in. thick

Std. pack 100

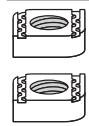

	Cat. no.	Size (in.)	Wt./C lb
	AB100-1/4EGC	1/4	7
	AB100-5/16EGC	5/16	8
	AB100-3/8EGC	3/8	9
	AB100-1/2EG	1/2	9
	AB100-5/8EG	5/8	10
	AB100-3/4EG	3/4	10

For use with all channels. Nut is square over 1/2 in. size.

### H100 Long spring nut\*

Std. pack 100

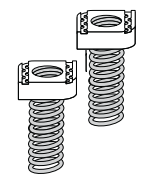

	Cat. no.	Size (in.)	Wt./C lb
	H100-3/8EGC	3/8	10
	H100-1/2EGC	1/2	14

For all E and H series channel and inserts.

### A182 to A185 Regular spring stud nut\*

Std. pack 100

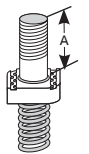

	Cat. no.	Bolt dia (in.)	Length A (in.)	Wt./C lb
Diagram	A182-1/4x100EG	1/4	1	10
	A182-1/4x125EG	1/4	1 1/4	15
	A184-3/8x100EG	3/8	1	10
	A184-3/8x125EG	3/8	1 1/4	15
	A185-1/2x100EG	1/2	1	10
	A185-1/2x125EG	1/2	1 1/4	15

For all A and C series channels.

### B100 Short spring nut\*

Std. pack 100

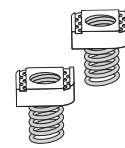

	Cat. no.	Size (in.)	Wt./C lb
	B100-1/4EGC	1/4	7
	B100-5/16EGC	5/16	8
	B100-3/8EGC	3/8	9
	B100-1/2EGC	1/2	9

Available in stainless steel 316.  
For all B and D series channel and inserts.

### AC100 Springless nut heavy-duty 3/8 in. thick

Std. pack 100

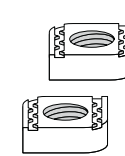

	Cat. no.	Size (in.)	Wt./C lb
	AC100-3/8EGC	3/8	9
	AC100-1/2EGC	1/2	11
	AC100-5/8EGC	5/8	18
	AC100-3/4EGC	3/4	18

For all A, C, E and H series channel and inserts.  
Nut is square over 1/2 in. size.

### A177 to A179 Springless stud nut

Std. pack 100

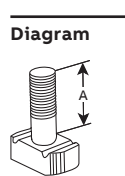

	Cat. no.	Bolt dia (in.)	Length A (in.)	Wt./C lb
Diagram	A177-1/4x100EG	1/4	1	8
	A177-1/4x125EG	1/4	1 1/4	10
	A179-3/8x100EG	3/8	1	13
	A179-3/8x125EG	3/8	1 1/4	13.5

For use with all channels.

### 813EG Springless nut light-duty

Std. pack 100

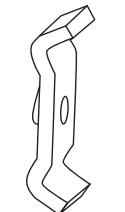

	Cat. no.	Size (in.)	Wt./C lb
	813EG	1/4	5

For use with all channels.

\*Supplied with a plastic sleeve over the spring portion to prevent tangling inside the carton.

## Threaded products and hardware

### E145 Standard hex nut

Std. pack 100

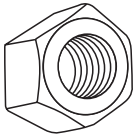

Cat. no.	Size (in.)	Wt./C lb
E145-1/4EGC	1/4	.72
E145-3/8EGC	3/8	1.60
E145-1/2EGC	1/2	2.78
E145-5/8EG	5/8	6.92
E145-3/4EGC	3/4	12.70
E145-7/8EGC	7/8	19.00
E145-1EGC	1	28.00

### 812 Stud nut

Std. pack 100

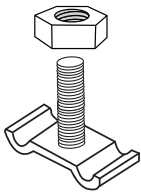

Cat. no.	Size (in.)	Wt./C lb
812-1EG	1/4 x 1	6

For attaching fixture to channel slot down or to channel slot up knockouts. Specify length. Hex nut included.

### UCN Universal nylon cone nut

Std. pack 100

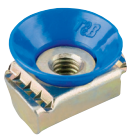

Cat. no.	Size (in.)	Wt./C lb
UCN-1/4	1/4	8
UCN-3/8	3/8	10
UCN-1/2	1/2	12

#### GoldGalv® only

For all 1 1/8 in. and 1 1/2 in. channels.

May be used with ALL strut depths.

Can be used for A100 series, B100 series and AB100 series.

### E147 Flat steel washer

Std. pack 100

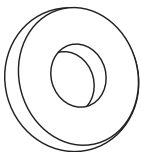

Cat. no.	Size (in.)	Wt./C lb
E147-1/4EG	1/4	0.67
E147-5/16EG	5/16	1.11
E147-3/8EG	3/8	1.49
E147-1/2EG	1/2	3.85
E147-5/8EG	5/8	7.69
E147-3/4EG	3/4	9.89
E147-7/8EG	7/8	15.40

Available in stainless steel.

### ES145 Swivel nut and jam nut combinations

Std. pack 100

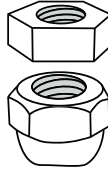

Cat. no.	Size (in.)	Wt./C lb
ES145-3/8	3/8	5.5
ES145-1/2	1/2	6.0

### AB102 Unhardened square nut

Std. pack 100

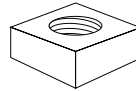

Cat. no.	Size (in.)	Wt./C lb
AB102-1/4	1/4	13
AB102-3/8	3/8	14
AB102-1/2	1/2	14
AB102-5/8	5/8	12
AB102-3/4	3/4	11
AB102-7/8	7/8	10

### E146 Standard square nut

Std. pack 100

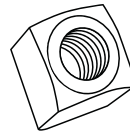

Cat. no.	Size (in.)	Wt./C lb
E146-1/4EG	1/4	.93
E146-5/16EG	5/16	1.60
E146-3/8EGC	3/8	2.65
E146-1/2EG	1/2	5.83
E146-5/8EG	5/8	10.80

### EF147 Fender washer

Std. pack 100

Cat. no.	Size (in.)	A (in.)	B (in.)	Wt./C lb
EF147-1/4EGC	1/4	1 1/4	5/16	3.1
EF147-3/8EGC	3/8	1 1/2	7/16	2.9
EF147-1/2EGC	1/2	2	9/16	5.0

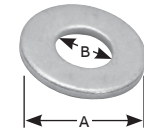

Available in stainless steel.

### E148 Lock washer

Std. pack 100



Cat. no.	Size (in.)	Wt./C lb
E148-1/4EG	1/4	0.26
E148-3/8EG	3/8	0.50
E148-1/2EG	1/2	1.09
E148-5/8EG	5/8	2.57

Available in stainless steel.

## Threaded products and hardware

### E142 Hex head cap screw

Std. pack 100



Cat. no.	Size (in.)	Wt./C lb
E142-1/4x100EG	¼ x 1	1.74
E142-1/4x150EG	¼ x 1½	2.43
E142-3/8x100EG	⅜ x 1	4.17
E142-3/8x150EG	⅜ x 1½	5.64
E142-1/2x100EG	½ x 1	8.94
E142-1/2x150EG	½ x 1½	10.00
E142-1/2x200EG	½ x 2	11.19
E142-1/2x225EG	½ x 2¼	11.90
E142-1/2x250EG	½ x 2½	12.52
E142-1/2x275EG	½ x 2¾	13.22

Available in stainless steel.

### E150S Lag bolt

Std. pack 50

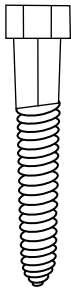

Cat. no.	Drill size (in.)	Size (in.)	Wt./C lb
E150S-3/8x1-1/2EG	¼	⅜ x 1½	5
E150S-3/8x2EG	¼	⅜ x 2	7
E150S-3/8x2-1/2EG	¼	⅜ x 2½	8
E150S-3/8x3EG	¼	⅜ x 3	9
E150S-1/2x1-1/2EG	11/32	½ x 1½	12
E150S-1/2x2EG	11/32	½ x 2	13
E150S-1/2x2-1/2EG	11/32	½ x 2½	15
E150S-1/2x3EG	11/32	½ x 3	18

### H104 Hanger rod continuous threaded

Std. pack 3

- Black available upon request
- Sold per foot; standard length, 10 ft.
- Also available in stainless steel (316) standard length 6 ft. (suffix SS6)
- National coarse thread

Cat. no.	Thread size (in.)	Wt./lb 100 ft.	Design Load lb
H104-1/4x10EGC	¼	12.5	150
H104-3/8x10EGC	⅜	29	610
H104-1/2x10EGC	½	53.5	1,130
H104-5/8x10EGC	⅝	85	1,810
H104-3/4x10EGC	¾	123	2,710
H104-7/8x10EG	7/8	130	3,770
H104-1x10EG	1	214	4,960

### H119 Rod couplings – standard

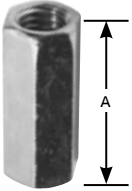
Diagram	Rod size	A (in.)	Wt./C lb
	¼	7/8	1.90
	5/16	7/8	3.75
	⅜	1½	3.50
	½	1¼	5.50
	⅝	2⅝	18.00
	¾	2¼	28.00
	7/8	2½	55.00
	1	2¼	56.00

Standard rod coupling

Example: H119-1/2EG

Order by product number, rod size, and finish.

Available in stainless steel.

### H119 Rod couplings – reducing

Rod size	A (in.)	Wt./C lb
¼ to ⅜	1½	3.50
⅜ to ½	1¼	6.70
½ to ⅝	1¼	14.00
⅝ to ¾	1½	21.00
¾ to 7/8	1¾	40.00

Rod reducer coupling

Example: H119-1/4x3/8EG

## Threaded products and hardware

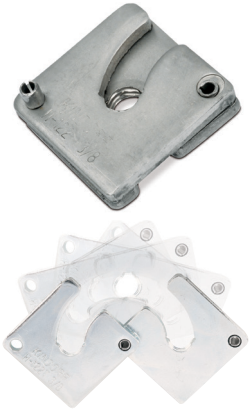

H122 Trapnut™ strut fastener

Cat. no.	Size (in.)	Design load (lb)	Std. ctn.
H 122 1/4	1/4	150	50
H 122 3/8	3/8	590	50
H 122 1/2	1/2	1,080	50
H 122 1/4 EG	1/4	150	50
H 122 3/8 EG	3/8	590	50
H 122 1/2 EG	1/2	1,080	50
H 122 3/8 SS6	3/8	590	50
H 122 1/2 SS6	1/2	1,080	50

Finishes – Electrogalvanized (EG), GoldGalv®, stainless steel type 316 (SS6)

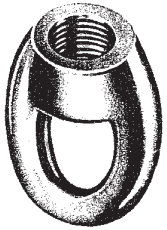

M117 Eye socket

	Rod size A (in.)	Pipe size (in.)	B (in.)	E (in.)	Wt./C lb	Design load, lb
Diagram	1/4	3/8	1/4	1 11/32	5	230
	3/8	1/2–2	1/4	1 11/32	7	610
	1/2	2 1/2–3 1/2	1/4	1 17/32	13	1,130
	5/8	4–5	3/8	1 13/16	19	1,810
	3/4	6	1/2	2 5/32	31	2,400
	7/8	8	1/2	2 11/32	44	2,800

Standard finishes – bare (B), electrogalvanized (EG)  
 Malleable iron. For attaching hanger rod to various types of hangers and beam clamps.  
 Order by product number, rod size, and finish. **Example: M117-1/4B**  
 Complies with Specification MSS SP69, Type 16.

E120 Swivel joint

	Cat. no.	Size (in.)	A (in.)	B (in.)	Wt./C lb	Design load, lb
Diagram	E120-3/8	3/8	1 3/8	3/8	15	1,000
	E120-1/2	1/2	1 1/2	1/2	25	1,800

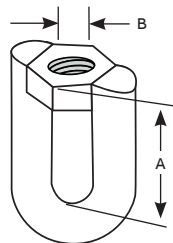

# Threaded products and hardware

## E120A Weldless eye nut

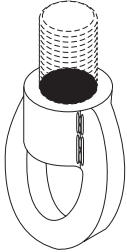

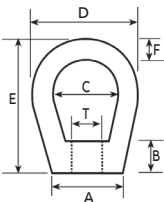
	Rod size T (in.)	A (in.)	B (in.)	C (in.)	D (in.)	E (in.)	F (in.)	Wt./C lb	Design load, lb
Diagram	3/8	7/8	5/8	1 1/4	2	2 1/2	3/8	20	2,700
	1/2	7/8	5/8	1 1/4	2	2 1/2	3/8	22	2,700
	5/8	1 3/8	3/4	1 1/2	2 1/2	3	1/2	60	5,000
	3/4	1 3/8	3/4	1 1/2	2 1/2	3	1/2	56	5,000
	7/8	1 1/2	1 5/8	1 5/16	3 5/8	4 1/2	3/4	174	10,000
	1	1 1/2	1 5/8	1 5/16	3 5/8	4 1/2	3/4	168	10,000

Standard finish – bare (B)  
 Drop forged steel. For use on high temperature piping installations.  
 Order by product number and rod size. **Example: E120A-3/8B**

## E122 Swivel joint

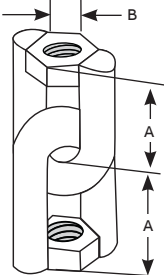
	Cat. no.	Size (in.)	A (in.)	B (in.)	Wt./C lb	Design load, lb
Diagram	E122-3/8	3/8	1 3/8	3/8	28	1,000
	E122-1/2	1/2	1 1/2	1/2	48	1,800

## E130 Swivel joint

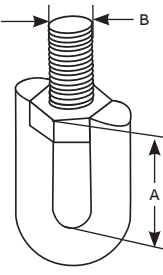
	Cat. no.	Size (in.)	A (in.)	B (in.)	Wt./C lb	Design load, lb
Diagram	E130-3/8	3/8	1 3/8	3/8	23	1,000
	E130-1/2	1/2	1 1/2	1/2	48	1,800

## E131 Swivel joint

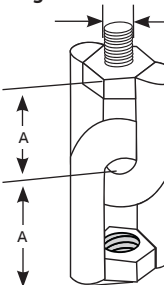
	Cat. no.	Size (in.)	A (in.)	B (in.)	Wt./C lb	Design load, lb
Diagram	E131-3/8	3/8	1 3/8	3/8	25	1,000
	E131-1/2	1/2	1 1/2	1/2	52	1,800

## Threaded products and hardware

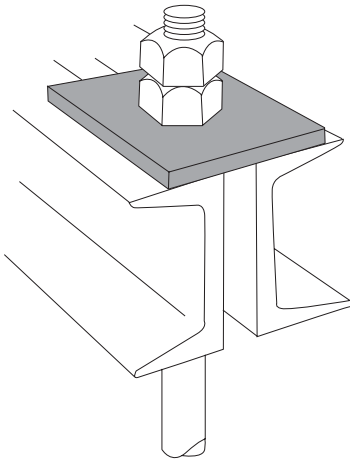

**C781 Square washer**  
Std. pack 50

Cat. no.	Rod size (in.)	Hole size (in.)	Overall dimensions (in.)	Wt./C lb
C781-3/8*	3/8	7/16	3 x 3 x 3/16	27
C781-1/2*	1/2	9/16	3 x 3 x 3/16	27
C781-5/8*	5/8	11/16	3 x 3 x 1/4	47
C781-3/4*	3/4	13/16	3 x 3 x 1/4	42
C781-7/8*	7/8	15/16	4 x 4 x 3/8	85
C781-1*	1	1 1/8	4 x 4 x 3/8	160

Used for beam applications. For channel applications, use AB241.

\*Finishes

- B
- HDG
- EG
- SS6