

—  
G

## Carlton® - Conduit and fittings



---

# Table of contents

## Section G

<b>Rigid nonmetallic conduit</b>	G4
<b>Schedule 40 elbows</b>	G5
<b>PVC conduit repair system</b>	G6
<b>Fittings and accessories</b>	G8
<b>Conduit bodies</b>	G13
<b>Junction boxes</b>	G16
<b>Conduit sleeve couplings</b>	G17
<b>Switch boxes</b>	G19
<b>Covers</b>	G22
<b>Support straps</b>	G27
<b>Clamps</b>	G28
<b>General information</b>	G29
<b>DB/2 PVC conduit</b>	G32
<b>DB/2 duct fittings</b>	G33
<b>DB/2 sweeps</b>	G34
<b>PVC trenchless raceway – Bore-Gard®</b>	G35
<b>PVC boreable conduit – Multi-Gard®</b>	G37
<b>Split duct</b>	G38
<b>Split kits</b>	G40
<b>Snap-Loc™ spacers</b>	G42
<b>Snap-N-Stac® combo spacers</b>	G45
<b>Carflex® liquidtight flexible conduit</b>	G49
<b>Carflex X-Flex™ liquidtight flexible tubing</b>	G50
<b>Carflex liquidtight fittings</b>	G51

---

# Table of contents

## Section G

<b>Carflex one-piece liquidtight fittings</b>	G53
<b>Plenum-Gard®</b>	G55
<b>Riser-Gard™</b>	G57
<b>Hal-Free Riser-Gard</b>	G60
<b>Resi-Gard™</b>	G61
<b>Micro-Gard™</b>	G63
<b>Flex-Plus® Blue™ ENT</b>	G65
<b>Stub-downs</b>	G66
<b>ENT accessories</b>	G67
<b>Mud box assemblies</b>	G70
<b>Mounting brackets and ENT bridge</b>	G72
<b>ENT technical information</b>	G73
<b>Low voltage brackets and kits</b>	G74
<b>Low voltage brackets</b>	G75
<b>3-Gang recessed plate</b>	G76
<b>Cements</b>	G78
<b>Primers</b>	G80
<b>Sealers</b>	G81
<b>Installation instructions / cement joints</b>	G82
<b>Conduit cutters</b>	G83
<b>EZ BEND™ conduit bending equipment</b>	G84
<b>PV-Mold®</b>	G86

## Rigid nonmetallic conduit

### Carlton Schedule 40 PVC rigid — Nonmetallic conduit (heavy wall EPC)

Certified for underground applications encased in concrete or direct burial. Also for use in exposed or concealed above ground applications.

- Sunlight resistant
- Rated for use with 75 °C conductors
- Superior weathering characteristics
- Meets CSA Standard C22.2 No. 211.2
- ¾ in. – 4 in. are FT-4 rated

#### Schedule 40 heavy wall



Cat. no.	Trade size (in.)		Std. crate qty.		Std. bundle qty.		Wt. per 100 ft.	Dimensions (in.)		Wall (in.)	
	10 ft.	20 ft.	10 ft.	20 ft.	10 ft.	20 ft.		O.D.	I.D.		
49005CC-010		–	½	6000	12000	100	200	17	0.840	0.622	0.109
49007CC-010	49007CC-020		¾	4400	8800	100	200	23	1.050	0.824	1.113
49008CC-010	49008CC-020		1	3600	7200	100	200	34	1.315	1.049	0.133
49009CC-010	49009CC-020		1¼	3300	6600	50	100	46	1.660	1.380	0.140
49010CC-010	49010CC-020		1½	1800	3600	50	100	55	1.900	1.610	0.145
49011CC-010	49011CC-020		2	1400	2800	50	100	73	2.375	2.067	0.154
49012CC-010	49012CC-020		2½	930	1860	10	20	124	2.875	2.469	0.203
49013CC-010	49013CC-020		3	880	1760	10	20	163	3.500	3.068	0.216
49014CC-010	–		3½	630	–	10	20	196	4.000	3.548	0.226
49015CC-010	49015CC-020		4	570	1140	10	20	232	4.500	4.026	0.237
49016CC-010	–		5	380	760	10	20	315	5.563	5.047	0.258
49017CC-010	49017CC-020		6	260	520	10	20	409	6.625	6.065	0.280



#### Acceptable dimension in inches of CSA listed integral bell

Trade size of conduit (in.)	A		B		C	
	At entrance (in.)		At bottom (in.)		Socket depth (in.)	
	Max.	Min.	Max.	Min.	Max.	Min.
½	0.860	0.844	0.844	0.828	1.500	0.652
¾	1.074	1.054	1.056	1.036	1.500	0.719
1	1.340	1.320	1.320	1.300	1.875	0.875
1¼	1.689	1.665	1.667	1.643	2.000	0.938
1½	1.930	1.906	1.906	1.882	2.000	1.062
2	2.405	2.381	2.381	2.357	2.000	1.125
2½	2.905	2.875	2.883	2.853	3.000	1.469
3	3.530	3.500	3.507	3.477	3.125	1.594
3½	4.065	3.965	4.007	3.977	3.250	1.687
4	4.565	4.465	4.506	4.476	3.375	1.750
5	5.653	5.543	5.583	5.523	3.625	1.937
6	6.708	6.608	6.644	6.584	3.750	2.125



## Schedule 40 elbows

Integral belled end for use with nonmetallic solvent weld fittings

### 90° Elbow

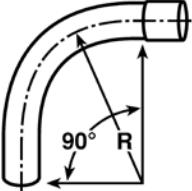

Item	Belled end cat. no.	Trade size (in.)	Std. ctn. qty.
	UA9ADCB-CTN	½	40
	UA9AECB-CTN	¾	25
	UA9AFCB-CTN	1	25
	UA9AGCB-UPC	1¼	20
	UA9AHCB-UPC	1½	25
	UA9AJCB-UPC	2	20
	UA9AKCB-CTN	2½	10
	UA9ALCB-UPC	3	25
	UA9AMCB	3½	1
	UA9ANCB	4	1
	UA9APCB	5	1
	UA9ARCB	6	1

Custom elbows available on request. Plain end elbows also available.

### 30° Elbow

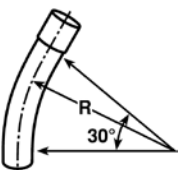

Item	Belled end cat. no.	Trade size (in.)	Std. ctn. qty.
	UA6ADB	½	50
	UA6AEB	¾	25
	UA6AFB	1	8
	UA6AGB	1¼	20
	UA6AHB	1½	1

### 45° Elbow

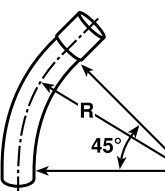

Item	Belled end cat. no.	Trade size (in.)	Std. ctn. qty.
	UA7ADCB-CTN	½	25
	UA7AECB-CTN	¾	20
	UA7AFCB-CTN	1	14
	UA7AGCB	1¼	20
	UA7AHCB	1½	20
	UA7AJCB	2	20
	UA7ALCB	3	5
	UA7AMCB	3½	1
	UA7ANCB	4	1
	UA7APCB	5	1
	UA7ARCB	6	1

### Flexible elbows



Item	Belled end cat. no.	Trade size (in.)	Std. ctn. qty.
	UAFAD	½	8
	UAFAE	¾	6
	UAFAF	1	6

### Integral belled end dimensions

Trade size of conduit (in.)	A		B		C	
	At entrance (in.)		At bottom (in.)		Socket depth (in.)	
	Max.	Min.	Max.	Min.	Max.	Min.
½	0.860	0.844	0.844	0.828	1.500	0.652
¾	1.074	1.054	1.056	1.036	1.500	0.719
1	1.340	1.320	1.320	1.300	1.875	0.875
1¼	1.689	1.665	1.667	1.643	2.000	0.938
1½	1.930	1.906	1.906	1.882	2.000	1.062
2	2.405	2.381	2.381	2.357	2.000	1.125
2½	2.905	2.875	2.883	2.853	3.000	1.469
3	3.530	3.500	3.507	3.477	3.125	1.594
3½	4.065	3.965	4.007	3.977	3.250	1.687
4	4.565	4.465	4.506	4.476	3.375	1.750
5	5.653	5.543	5.583	5.523	3.625	1.937
6	6.708	6.608	6.644	6.584	3.750	2.125

Diagram

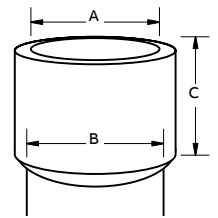

### Standard radius elbow dimensions

Trade size (in.)	A (in.)	B (in.)		C (in.)	
		Min. (radius)	Min.	Min.	Min.
½	0.840	4	1½		
¾	1.050	4½	1½		
1	1.315	5¼	1⅞		
1¼	1.660	7¼	2		
1½	1.900	8¼	2		
2	2.375	9½	2		
2½	2.875	10½	3		
3	3.500	13	3⅞		
3½	4.000	15	3¼		
4	4.500	16	3⅞		
5	5.563	24	3⅞		
6	6.625	30	3¼		

Diagrams

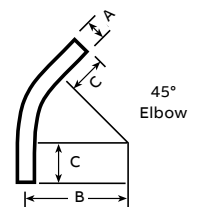
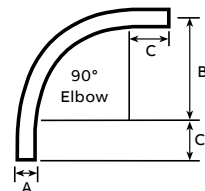

## PVC conduit repair system



The revolutionary Carlon PVC conduit repair system significantly reduces the time and money associated with repairing broken PVC conduit "stub-ups" in concrete slabs.

The system is a line of couplings, adapters, reamers and plugs designed to allow contractors to quickly and easily repair broken PVC conduit without having to chip away and repour concrete, while still maintaining the inside diameter of the conduit. Simply cut off the broken conduit; ream the I.D. of the conduit; and insert a coupling or adapter, it's that easy.

### Features

- cULus listed
- Nonmetallic couplings, adapters and plugs won't rust or corrode
- Available in sizes ½ in. through 2 in.

### Benefits

- Saves time and money
- Maintains inside diameter of conduit
- Metallic reamers for extra strength, durability and longer life
- Quickly and easily repair broken PVC conduit

### Couplings



	Cat. no.	Trade size (in.)	Std. ctn. qty.
	E910D	½	25
	E910E	¾	25
	E910F	1	15
	E910G	1¼	10
	E910H	1½	10
	E910J	2	10

### Male threaded adapters



	Cat. no.	Trade size (in.)	Std. ctn. qty.
	E920D	½	25
	E920E	¾	25
	E920F	1	15
	E920G	1¼	10
	E920H	1½	10
	E920J	2	10

### Reamers



	Cat. no.	Trade size (in.)	Std. ctn. qty.	
	E910REAMD	½	12	
	E910REAME	¾	12	
	E910REAMF	1	10	
	E910REAMG	1¼	10	
	E910REAMH	1½	10	
	E910REAMJ	2	10	
	E910REAMKIT	All sizes – ½, ¾, 1, 1¼, 1½ and 2		5

### Schedule 40 plugs



	Cat. no.	Trade size (in.)	Std. ctn. qty.
	HL6X*	½	1 bag of 50
	HL10*	¾	1 bag of 50
	HL13A*	1	1 bag of 50
	HL16*	1¼	1 bag of 50
	HL18*	1½	1 bag of 50
	HL21*	2	1 bag of 50

\* = Suffixe (R: red, B: blue, Y: yellow)

# PVC conduit repair system

## Instructions



Coupling  
E910 series



Male threaded adapter  
E920 series



Broken conduit on jobsite



**1** Cut broken conduit off flush.



**2** Insert plug to keep conduit clean/dry through balance of rough-in. Once rough-in is complete, remove plug and continue with step 3.

### Alternative to conduit repairs

Prior to concrete pour, measure and saw cut all conduit stub-ups to the thickness of the concrete pour. Insert plugs. Pour concrete flush to the conduit. When pour is complete, remove plugs and proceed with step 3. This alternative method saves time/money by eliminating the need for transitions or use of metal elbows.



**3** With reamer tool and standard 1/2 in. drill, ream I.D. of conduit.

It is recommended to use a variable-speed drill. Use slower speed to avoid overheating the conduit.



**4** The guide will direct the cutter; the stop will touch when completed.

### Cementing instructions

- A. Clean socket I.D. and spigot O.D. of dirt and moisture.
- B. Apply a uniform coat of cement to spigot end and push onto socket bottom, rotating 1/4 turn.
- C. Allow time to set before disturbing. This will depend upon temperature.



Apply a uniform coat of cement.



Insert fitting.



Rotate 1/4 turn.

**5** Insert the coupling and cement into place using the cement manufacturer's instructions.

## Fittings and accessories

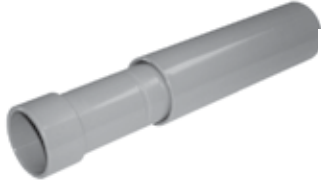

Coupling end



Male terminal adapter end

### Expansion fittings\*

E945 series expansion fittings are designed to compensate for length changes due to temperature variations in exposed conduit runs.

- Exclusive molded-in mid-point indicator on the piston
- Exclusive 2 in. expansion fitting with an 8 in. travel distance
- Two-piece molded design with lubricated seals for easier movement for the life of the product
- Ridges on the fitting for easier installation (sizes 2 in. through 6 in. only)
- Male terminal adapter end design (½ in. – 2 in. NPT threads and 2½ in. – 6 in. NPSC threads)
- Two O-rings to prevent leakage
- Can be installed vertically or horizontally



Coupling end cat. no.	Male terminal adapter end cat. no.	Size (in.)	Std. ctn. qty.	Travel length (in.)
E945D	E945DX	½	20	4
E945E	E945EX	¾	15	4
E945F	E945FX	1	10	4
E945G	E945GX	1¼	5	4
E945H	E945HX	1½	5	4
E945J	E945JX	2	15	8
E945K	E945KX	2½	10	8
E945L	E945LX	3	10	8
E945M	E945MX	3½	5	8
E945N	E945NX	4	5	8
E945P	E945PX	5	1	8
E945R	E945RX	6	1	8

\* Please refer to [page 30](#) for additional information.



Socket type for joining nonmetallic conduit.

### Standard couplings

All socket fittings should be attached using Carlon solvent cement. Using Carlon fittings with Carlon nonmetallic conduit ensures system integrity.



Cat. no.	Size (in.)	Std. ctn. qty.	Typical (in.)		I.D. (in.)	O.D. (in.)	Typical (in.)	
			A	B			C	L
CE940DR-CTN	½	75	0.852	0.836	0.728	1 <sup>7</sup> / <sub>64</sub>	1 <sup>11</sup> / <sub>16</sub>	1½
CE940ER-CTN	¾	45	1.064	1.046	0.840	1 <sup>5</sup> / <sub>16</sub>	¾	1½
CE940F-UPC	1	50	1.330	1.310	1.210	1 <sup>5</sup> / <sub>8</sub>	1 <sup>1</sup> / <sub>16</sub>	2
E940G	1¼	30	1.677	1.655	1.535	1 <sup>63</sup> / <sub>64</sub>	1	2½
E940H	1½	25	1.918	1.894	1.755	2 <sup>15</sup> / <sub>64</sub>	1 <sup>1</sup> / <sub>8</sub>	2¾
E940J	2	30	2.393	2.369	2.190	2 <sup>47</sup> / <sub>64</sub>	1 <sup>3</sup> / <sub>16</sub>	2½
E940K	2½	20	2.890	2.868	2.688	3 <sup>5</sup> / <sub>16</sub>	1 <sup>33</sup> / <sub>64</sub>	3 <sup>3</sup> / <sub>16</sub>
E940L	3	25	3.515	3.492	3.375	3 <sup>33</sup> / <sub>32</sub>	1¾	3 <sup>13</sup> / <sub>32</sub>
E940M	3½	20	4.015	3.992	3.780	4 <sup>9</sup> / <sub>16</sub>	1¾	3¾
E940N	4	15	4.515	4.491	4.265	5 <sup>3</sup> / <sub>32</sub>	1 <sup>25</sup> / <sub>32</sub>	3¾
E940P	5	8	5.593	5.553	5.097	6¼	1 <sup>15</sup> / <sub>16</sub>	4½
E940R	6	5	6.658	6.614	6.115	7½	2 <sup>3</sup> / <sub>16</sub>	4¾

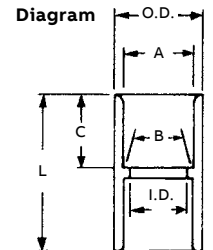

### Short expansion couplings\*

(Expands to a maximum of 2 in.)



Cat. no.	Size (in.)	Std. ctn. qty.
E955D	½	40
E955E	¾	40
E955F	1	25
E955G	1¼	15
E955H	1½	10
E955J	2	6

\* Please refer to [page 30](#) for additional information.



## Fittings and accessories



### Female adapters

For adapting nonmetallic conduit to threaded fittings, metallic systems. Female threads on one end, socket end on other.



### Male terminal adapters

For adapting nonmetallic conduit to boxes threaded fittings, metallic systems. Male threads on one end, socket end on other.

Cat. no.	Size (in.)	Std. ctn. qty.	Typical (in.)		Min. I.D. (in.)	Max. O.D. (in.)	Typical (in.)		
			A	B			C	T	L
E942D	1/2	150	0.852	0.836	0.620	1 1/64	1 1/16	3/4	1 9/16
E942E	3/4	100	1.064	1.046	0.822	1 1/16	1 3/16	3/4	1 9/16
E942F	1	50	1.330	1.310	1.046	1 5/8	1 5/16	7/8	1 15/16
E942G	1 1/4	30	1.677	1.655	1.377	1 63/64	1	7/8	2
E942H	1 1/2	25	1.918	1.894	1.607	2 5/32	1 1/8	7/8	2 7/32
E942J	2	30	2.393	2.369	2.064	2 47/64	1 3/16	1	2 5/16
E942K	2 1/2	20	2.890	2.868	2.450	3 11/32	1 5/8	1 1/8	2 15/16
E942L	3	25	3.515	3.492	3.000	3 31/32	1 3/4	1 1/8	3 1/16
E942M	3 1/2	20	4.015	3.992	3.500	4 1/2	1 7/8	1 1/8	3 1/4
E942N	4	15	4.515	4.491	4.000	5 1/64	1 3/4	1 1/16	3 13/64
E942P	5	8	5.593	5.553	5.047	6 1/4	1 15/16	1 1/16	3 3/16
E942R	6	6	6.658	6.614	6.055	7 1/4	2 1/8	1 1/16	3 3/8

Cat. no.	Size (in.)	Std. ctn. qty.	Typical (in.)		Min. D. (in.)	Max. O.D. (in.)	Typical (in.)		
			A	B			C	S	L
E943D	1/2	150	0.852	0.836	0.594	1.042	0.652	0.545	1.310
E943E	3/4	100	1.064	1.046	0.793	1.290	0.809	0.553	1.470
E943F	1	50	1.330	1.310	1.025	1.580	0.965	0.812	1.902
E943G	1 1/4	30	1.677	1.655	1.345	1.973	1.208	0.816	1.986
E943H	1 1/2	25	1.918	1.894	1.574	2.188	1.155	0.802	2.105
E943J	2	30	2.393	2.369	1.998	2.713	1.145	0.825	2.093
E943K	2 1/2	20	2.890	2.868	2.400	3.290	1.490	0.812	2.480
E943L	3	25	3.515	3.492	2.989	3.965	1.643	0.797	2.660
E943M	3 1/2	20	4.015	3.992	3.405	4.515	1.720	0.802	2.740
E943N	4	15	4.515	4.491	3.895	5.065	1.788	0.733	2.830
E943P	5	8	5.593	5.553	4.900	6.104	1.935	0.990	3.200
E943R	6	6	6.658	6.614	5.900	7.288	2.128	0.985	3.410

Diagram

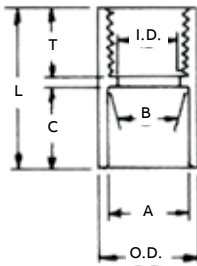

Diagram

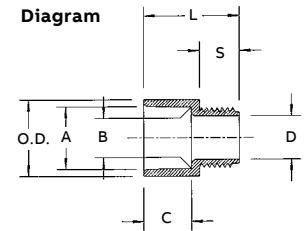

## Fittings and accessories



### Reducer bushings

For connecting different sizes of conduit. Bell x spigot.

Cat. no.	Size (in.)	Std. ctn. qty.	Typical (in.)		
			L	A	C
E950ED	¾ x ½	100	1 <sup>5</sup> / <sub>32</sub>	1 <sup>3</sup> / <sub>64</sub>	1 <sup>1</sup> / <sub>32</sub>
E950FD-CAR	1 x ½	25	1 <sup>11</sup> / <sub>32</sub>	3 <sup>1</sup> / <sub>16</sub>	5 <sup>7</sup> / <sub>64</sub>
E950FE	1 x ¾	100	1 <sup>11</sup> / <sub>32</sub>	3 <sup>1</sup> / <sub>16</sub>	1 <sup>1</sup> / <sub>64</sub>
E950GE-CAR	1¼ x ¾	10	1 <sup>15</sup> / <sub>32</sub>	3 <sup>1</sup> / <sub>16</sub>	1 <sup>1</sup> / <sub>64</sub>
E950GF	1¼ x 1	50	1 <sup>15</sup> / <sub>32</sub>	3 <sup>1</sup> / <sub>16</sub>	1 <sup>9</sup> / <sub>64</sub>
E950HF-CAR	1½ x 1	10	1 <sup>19</sup> / <sub>32</sub>	3 <sup>1</sup> / <sub>16</sub>	1 <sup>9</sup> / <sub>64</sub>
E950HG-CAR	1½ x 1¼	10	1 <sup>19</sup> / <sub>32</sub>	3 <sup>1</sup> / <sub>16</sub>	1 <sup>17</sup> / <sub>64</sub>
E950JG-CAR	2 x 1¼	10	1¾	7 <sup>1</sup> / <sub>32</sub>	1 <sup>17</sup> / <sub>64</sub>
E950JH-CAR	2 x 1½	10	1¾	7 <sup>1</sup> / <sub>32</sub>	1 <sup>25</sup> / <sub>64</sub>
E950KJ-CAR	2½ x 2	10	2 <sup>5</sup> / <sub>32</sub>	3 <sup>3</sup> / <sub>8</sub>	1 <sup>27</sup> / <sub>64</sub>
E950LJ-CAR	3 x 2	10	2½	¾	1 <sup>7</sup> / <sub>8</sub>
E950LK	3 x 2½	25	1 <sup>15</sup> / <sub>16</sub>	¾	1 <sup>11</sup> / <sub>16</sub>
E950NL	4 x 3	25	2¾	5 <sup>1</sup> / <sub>16</sub>	1 <sup>15</sup> / <sub>16</sub>

Diagram

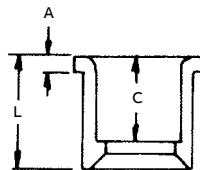

### Box adapters for enclosures

Adapts nonmetallic conduit to all electrical enclosures by inserting adapter through knockout and cementing into Carlon couplings.

Cat. no.	Size (in.)	Std. ctn. qty.	Min. D (in.)	O.D. typical (in.)	Max. X (in.)	Typical (in.)	
						CM	L
E996D	½	100	0.662	0.840	1 <sup>7</sup> / <sub>64</sub>	2 <sup>3</sup> / <sub>32</sub>	2 <sup>7</sup> / <sub>32</sub>
E996E	¾	100	0.824	1.050	1 <sup>21</sup> / <sub>64</sub>	2 <sup>5</sup> / <sub>32</sub>	2 <sup>9</sup> / <sub>32</sub>
E996F	1	100	1.049	1.315	1 <sup>5</sup> / <sub>8</sub>	6 <sup>1</sup> / <sub>64</sub>	1 <sup>3</sup> / <sub>32</sub>
E996G	1¼	50	1.380	1.660	1 <sup>31</sup> / <sub>32</sub>	1 <sup>1</sup> / <sub>16</sub>	1¼
E996H	1½	50	1.610	1.900	2 <sup>13</sup> / <sub>64</sub>	1 <sup>3</sup> / <sub>16</sub>	1 <sup>3</sup> / <sub>8</sub>
E996J	2	25	2.067	2.375	2 <sup>29</sup> / <sub>32</sub>	1¼	1 <sup>7</sup> / <sub>16</sub>
E996K	2½	15	2.469	2.875	3 <sup>7</sup> / <sub>16</sub>	1 <sup>7</sup> / <sub>8</sub>	1 <sup>15</sup> / <sub>16</sub>
E996L	3	20	3.068	3.500	4 <sup>1</sup> / <sub>8</sub>	2	2 <sup>1</sup> / <sub>16</sub>
E996N	4	10	4.026	4.500	5 <sup>1</sup> / <sub>8</sub>	2½	2¾

Diagram

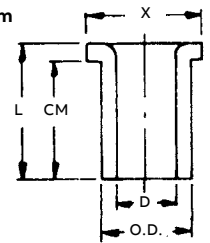

### Threaded adapters

Cat. no.	Size (in.)	Std. ctn. qty.
E9842D 1	½	25
E9842E 2	¾	25

1 Fits ¾ in. sockets

2 Fits 1 in. sockets



### Plugs with pull tabs (polyethylene)

Cat. no.	Size (in.)	Std. ctn. qty.	Std. ctn. wt. (lb)
P258JT	2	60	3
P258LT	3	30	3
P258NT	4	48	8
P258PT	5	30	6
P258RT	6	30	9

## Fittings and accessories

### Service entrance caps



Cat. no.	Size (in.)	Std. ctn. qty.	Dimensions (in.)			
			E	F	G	H
E998D	½	5	1.76	0.45	0.45	-
E998E	¾	20	1.76	0.45	0.45	-
E998F	1	15	2.26	0.59	0.58	-
E998G	1¼	20	3.52	0.74	0.71	0.50
E998H	1½	10	3.52	0.74	0.71	0.50
E998J	2	5	4.26	0.83	0.78	0.56
E998K-UPC	2½	2	7.47	1.70	1.31	1.00
E998L	3	2	7.47	1.70	1.31	1.00
E998N	4	2	10.45	2.25	1.88	1.31



#### Diagrams

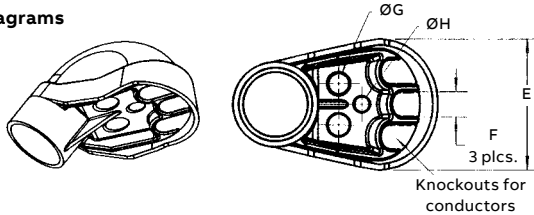

### End caps

Cat. no.	Size (in.)	Std. ctn. qty.	Std. ctn. wt. (lb)
E958D	½	100	3
E958E	¾	100	4
E958F	1	75	5
E958G	1¼	40	4
E958H	1½	30	4
E958J	2	25	5
E958K	2½	10	4
E958L	3	10	5
E958N	4	5	17
E958P	5	5	11
E958R	6	5	13



### Meter hubs

Cat. no.	Size (in.)	Std. ctn. qty.	Std. ctn. wt. (lb)
E991G	1¼	20	3.8
E991G-UPC	1¼	12	2.3
E991H	1½	25	8.0
E991J	2	6	1.0
E991J-UPC	2	12	2.0



### Meter offset

Cat. no.	Size (in.)	Std. ctn. qty.	Offset (in.)	A (in.)
E995G	1¼	15	0.758	4.230
E995J	2	8	0.684	4.270



### Offset

Cat. no.	Size (in.)	Std. ctn. qty.	Std. ctn. wt. (lb)
E994D	½	25	3
E994E	¾	25	3
E994F	1	50	12



### End bells



Cat. no.	Size (in.)	Std. ctn. qty.	Std. ctn. wt. (lb)
E997F	1	50	2.6
E997G	1¼	35	2.5
E997H	1½	30	2.5
E997J	2	40	5.0
E997K	2½	30	2
E997L	3	50	10
E997M	3½	40	11
E997N	4	30	16
E997P	5	15	8
E997R	6	10	7
E997T	8	3	15



## Fittings and accessories



### Flat sealing washer

Where a waterproof termination is required into any enclosure (metallic or nonmetallic), install the neoprene washer over the threads of a terminal adapter before inserting into the enclosure. Use a standard locknut or threaded bushing to secure the assembly.

Cat. no.	Size (in.)	Std. ctn. qty.
E943DW	½	125
E943EW	¾	125
E943FW	1	100
E943GW	1¼	50
E943HW	1½	50
E943JW	2	25



### Holform™ concrete sleeves

Holform nonmetallic concrete sleeve forms are the easy way to form holes in concrete. They install in seconds with nails, screws or staples and are easily removed. Concrete will not adhere to them. Holform are adjustable to any slab thickness. (Not CSA applicable)

Cat. no.	Min. O.D. A (in.)	B (in.)	Std. ctn. qty.	Std. ctn. wt. (lb)
E92CSH	1½	1¾	20	3
E92CSJ	2	2 <sup>13</sup> / <sub>32</sub>	25	6
E92CSL	3	3 <sup>13</sup> / <sub>32</sub>	25	8
E92CSN	4	4 <sup>13</sup> / <sub>32</sub>	18	8
E92CSP	5	5 <sup>13</sup> / <sub>32</sub>	15	8
E92CSR	6	6 <sup>13</sup> / <sub>32</sub>	12	8

Diagram

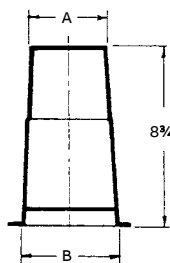

### Conduit bodies type x with cover

Four knockout type socket openings, 90° spacing. Available with ½ in. or ¾ in. socket outlets. Includes cover and gasket.



Cat. no.	Size (in.)	Vol. (cu. in.)	Std. ctn. qty.
CE970CDE	½	15.16	15
E970CE	¾	15.16	15

### Diagrams

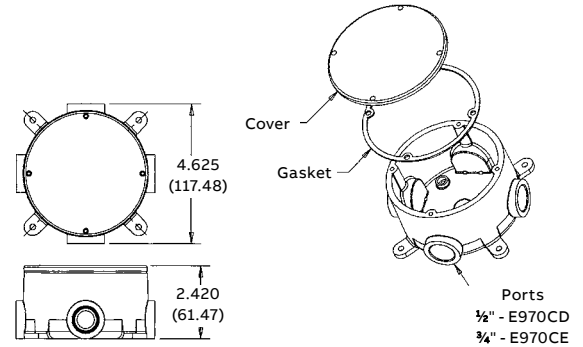

Supplied with 4 stainless steel cover screws. Diameter 4<sup>1</sup>/<sub>8</sub> in., Thickness ¼ in. Not designed for use with wiring devices or light fixtures.



### Access pull elbows



Cat. no.	Size (in.)	Std. ctn. qty.	Typical (in.)			
			A	B	C	D
E990D	½	75	0.852	0.836	2.187	0.718
E990DR-CAR	½	25	0.852	0.836	2.187	0.718
E990E	¾	50	1.064	1.046	2.531	0.781

Diagram

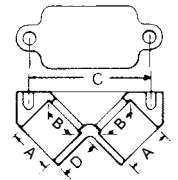

Gasket included

## Conduit bodies



### Type LB

- Hubs are not threaded
- Textured lids
- Foam-in-place gasket

Cat. No.	Size (in.)	Std. ctn. qty.	Typical C	Max. L1 (in.)	Typical (in.)			Max. (in.)		Vol. (cu. in.)
					L2	L3	H	Q	W	
E986D	½	25	1 <sup>1</sup> / <sub>16</sub>	4 <sup>5</sup> / <sub>16</sub>	3 <sup>7</sup> / <sub>32</sub>	3 <sup>1</sup> / <sub>16</sub>	1 <sup>5</sup> / <sub>16</sub>	1 <sup>11</sup> / <sub>32</sub>	1 <sup>1</sup> / <sub>2</sub>	4.0
E986E	¾	15	2 <sup>9</sup> / <sub>32</sub>	6 <sup>9</sup> / <sub>32</sub>	5 <sup>9</sup> / <sub>32</sub>	4 <sup>25</sup> / <sub>32</sub>	1 <sup>25</sup> / <sub>32</sub>	1 <sup>3</sup> / <sub>4</sub>	2 <sup>1</sup> / <sub>32</sub>	12.0
E986F	1	10	2 <sup>9</sup> / <sub>32</sub>	6 <sup>9</sup> / <sub>32</sub>	5 <sup>9</sup> / <sub>32</sub>	4 <sup>25</sup> / <sub>32</sub>	1 <sup>25</sup> / <sub>32</sub>	1 <sup>3</sup> / <sub>4</sub>	2 <sup>1</sup> / <sub>32</sub>	12.0
E986G	1¼	10	1 <sup>3</sup> / <sub>32</sub>	7 <sup>31</sup> / <sub>32</sub>	6 <sup>13</sup> / <sub>32</sub>	6	2 <sup>5</sup> / <sub>16</sub>	2 <sup>1</sup> / <sub>2</sub>	2 <sup>3</sup> / <sub>4</sub>	32.0
E986H	1½	10	1 <sup>3</sup> / <sub>32</sub>	7 <sup>31</sup> / <sub>32</sub>	6 <sup>13</sup> / <sub>32</sub>	6	2 <sup>5</sup> / <sub>16</sub>	2 <sup>1</sup> / <sub>2</sub>	2 <sup>3</sup> / <sub>4</sub>	32.0
E986J	2	10	1 <sup>5</sup> / <sub>32</sub>	9 <sup>31</sup> / <sub>32</sub>	8 <sup>13</sup> / <sub>32</sub>	7¼	2 <sup>9</sup> / <sub>16</sub>	3 <sup>5</sup> / <sub>32</sub>	3 <sup>15</sup> / <sub>32</sub>	63.0
E986K	2½	4	1 <sup>5</sup> / <sub>8</sub>	14 <sup>7</sup> / <sub>8</sub>	13¼	11 <sup>31</sup> / <sub>32</sub>	3 <sup>3</sup> / <sub>4</sub>	4 <sup>11</sup> / <sub>32</sub>	4 <sup>5</sup> / <sub>8</sub>	210.0
E986L	3	4	1 <sup>5</sup> / <sub>8</sub>	14 <sup>7</sup> / <sub>8</sub>	13¼	11 <sup>31</sup> / <sub>32</sub>	3 <sup>3</sup> / <sub>4</sub>	4 <sup>11</sup> / <sub>32</sub>	4 <sup>5</sup> / <sub>8</sub>	210.0
E986M	3½	4	1 <sup>25</sup> / <sub>32</sub>	17 <sup>23</sup> / <sub>32</sub>	15 <sup>7</sup> / <sub>8</sub>	14 <sup>17</sup> / <sub>64</sub>	4 <sup>7</sup> / <sub>16</sub>	5 <sup>11</sup> / <sub>32</sub>	5 <sup>21</sup> / <sub>32</sub>	390.0
E986N	4	4	1 <sup>25</sup> / <sub>32</sub>	17 <sup>23</sup> / <sub>32</sub>	15 <sup>7</sup> / <sub>8</sub>	14 <sup>17</sup> / <sub>64</sub>	4 <sup>7</sup> / <sub>16</sub>	5 <sup>11</sup> / <sub>32</sub>	5 <sup>21</sup> / <sub>32</sub>	390.0

Diagram

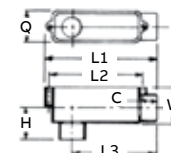

### Type E

- Hubs are not threaded
- Textured lids
- Foam-in-place gasket

Cat. no.	Size (in.)	Std. ctn. qty.	C (in.)	L1 (in.)	L2 (in.)	Q (in.)	W (in.)	Vol. (cu. in.)
E988D	½	25	1 <sup>1</sup> / <sub>16</sub>	4 <sup>5</sup> / <sub>16</sub>	3½	1 <sup>11</sup> / <sub>32</sub>	1½	4.0
E988E	¾	15	2 <sup>9</sup> / <sub>32</sub>	6 <sup>11</sup> / <sub>32</sub>	5 <sup>9</sup> / <sub>32</sub>	1¾	2 <sup>1</sup> / <sub>32</sub>	12.0
E988F	1	10	2 <sup>9</sup> / <sub>32</sub>	6 <sup>11</sup> / <sub>32</sub>	5 <sup>9</sup> / <sub>32</sub>	1¾	2 <sup>1</sup> / <sub>32</sub>	12.0
E988G	1¼	10	1 <sup>3</sup> / <sub>32</sub>	8	6 <sup>13</sup> / <sub>32</sub>	2½	2¾	32.0
E988H	1½	10	1 <sup>3</sup> / <sub>32</sub>	8	6 <sup>13</sup> / <sub>32</sub>	2½	2¾	32.0
E988J	2	10	1 <sup>5</sup> / <sub>32</sub>	9 <sup>15</sup> / <sub>32</sub>	8 <sup>13</sup> / <sub>32</sub>	3 <sup>5</sup> / <sub>32</sub>	3 <sup>15</sup> / <sub>32</sub>	63.0

Diagram

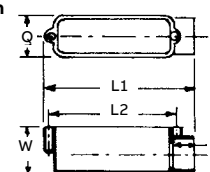

## Conduit bodies



### Type T

- Hubs are not threaded
- Textured lids
- Foam-in-place gasket

Cat. no.	Size (in.)	Std. ctn. qty.	Typical C (in.)	Max. L1 (in.)	Typical (in.)			Max. (in.)		Vol. (cu. in.)
					L2	L3	H	Q	W	
E983D-CAR	½	10	1 <sup>1</sup> / <sub>16</sub>	4 <sup>11</sup> / <sub>16</sub>	3 <sup>7</sup> / <sub>32</sub>	2 <sup>11</sup> / <sub>32</sub>	1 <sup>5</sup> / <sub>16</sub>	1 <sup>11</sup> / <sub>32</sub>	1½	4.0
E983E	¾	15	2 <sup>9</sup> / <sub>32</sub>	6 <sup>7</sup> / <sub>8</sub>	5 <sup>9</sup> / <sub>32</sub>	4 <sup>7</sup> / <sub>16</sub>	1 <sup>25</sup> / <sub>32</sub>	1¾	2 <sup>1</sup> / <sub>32</sub>	12.0
E983F	1	20	2 <sup>9</sup> / <sub>32</sub>	6 <sup>7</sup> / <sub>8</sub>	5 <sup>9</sup> / <sub>32</sub>	3 <sup>7</sup> / <sub>16</sub>	1 <sup>25</sup> / <sub>32</sub>	1¾	2 <sup>1</sup> / <sub>32</sub>	12.0
E983G	1¼	10	1 <sup>3</sup> / <sub>32</sub>	8 <sup>21</sup> / <sub>32</sub>	6 <sup>13</sup> / <sub>32</sub>	4 <sup>21</sup> / <sub>64</sub>	2 <sup>5</sup> / <sub>16</sub>	2½	2¾	32.0
E983H	1½	4	1 <sup>3</sup> / <sub>32</sub>	8 <sup>21</sup> / <sub>32</sub>	6 <sup>13</sup> / <sub>32</sub>	4 <sup>21</sup> / <sub>64</sub>	2 <sup>5</sup> / <sub>16</sub>	2½	2¾	32.0
E983J	2	10	1 <sup>5</sup> / <sub>32</sub>	10 <sup>5</sup> / <sub>16</sub>	8 <sup>13</sup> / <sub>32</sub>	5 <sup>5</sup> / <sub>32</sub>	2 <sup>9</sup> / <sub>16</sub>	3 <sup>5</sup> / <sub>32</sub>	3 <sup>15</sup> / <sub>16</sub>	63.0

Diagram

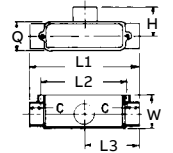

### Type LR

- Hubs are not threaded
- Textured lids
- Foam-in-place gasket

Cat. no.	Size (in.)	Std. ctn. qty.	Typical C (in.)	Max. L1 (in.)	Typical (in.)			Max. (in.)		Vol. (cu. in.)
					L2	L3	H	Q	W	
E985D-CAR	½	10	1 <sup>1</sup> / <sub>16</sub>	4 <sup>5</sup> / <sub>16</sub>	3 <sup>7</sup> / <sub>32</sub>	3 <sup>1</sup> / <sub>16</sub>	1 <sup>5</sup> / <sub>16</sub>	1 <sup>11</sup> / <sub>32</sub>	1½	4.0
E985E-CAR	¾	10	2 <sup>9</sup> / <sub>32</sub>	6 <sup>9</sup> / <sub>32</sub>	5 <sup>9</sup> / <sub>32</sub>	4 <sup>25</sup> / <sub>32</sub>	1 <sup>25</sup> / <sub>32</sub>	1¾	2 <sup>1</sup> / <sub>32</sub>	12.0
E985F-CAR	1	10	2 <sup>9</sup> / <sub>32</sub>	6 <sup>9</sup> / <sub>32</sub>	5 <sup>9</sup> / <sub>32</sub>	4 <sup>25</sup> / <sub>32</sub>	1 <sup>25</sup> / <sub>32</sub>	1¾	2 <sup>1</sup> / <sub>32</sub>	12.0
E985G-CAR	1¼	5	1 <sup>3</sup> / <sub>32</sub>	7 <sup>31</sup> / <sub>32</sub>	6 <sup>13</sup> / <sub>32</sub>	6	2 <sup>5</sup> / <sub>16</sub>	2½	2¾	32.0
E985H-CAR	1½	5	1 <sup>3</sup> / <sub>32</sub>	7 <sup>31</sup> / <sub>32</sub>	6 <sup>13</sup> / <sub>32</sub>	6	2 <sup>5</sup> / <sub>16</sub>	2½	2¾	32.0
E985J-CAR	2	3	1 <sup>5</sup> / <sub>32</sub>	9 <sup>9</sup> / <sub>32</sub>	8 <sup>13</sup> / <sub>32</sub>	7¼	2 <sup>9</sup> / <sub>16</sub>	3 <sup>5</sup> / <sub>32</sub>	3 <sup>15</sup> / <sub>32</sub>	63.0

Diagram

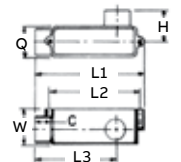

## Conduit bodies



### Type C

- Hubs are not threaded
- Textured lids
- Foam-in-place gasket

Cat. no.	Size (in.)	Std. ctn. qty.	Typical C (in.)	Max. L1 (in.)	Typical (in.)		Max. (in.)		Vol. (cu. in.)
					L2	Q	W		
E987D-CTN	1/2	8	1 1/16	4 1/16	3 1/2	1 1/32	1 1/2	4.0	
E987E-CAR	3/4	10	2 9/32	6 7/8	5 3 2/64	1 3/4	2 1/32	12.0	
E987F-CAR	1	10	2 9/32	6 7/8	5 9/32	1 3/4	2 1/32	12.0	
E987G-CAR	1 1/4	5	1 3/32	8 2 1/32	6 1 3/32	2 1/2	2 3/4	32.0	
E987H-CAR	1 1/2	4	1 3/32	8 2 1/32	6 1 3/32	2 1/2	2 3/4	32.0	
E987J	2	15	1 5/32	10 5/16	8 1 3/32	3 5/32	3 1 5/32	63.0	

Diagram

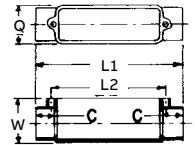

### Type LL

- Hubs are not threaded
- Textured lids
- Foam-in-place gasket

Cat. no.	Size (in.)	Std. ctn. qty.	Typical C (in.)	Max. L1 (in.)	Typical (in.)			Max. (in.)		Vol. (cu. in.)
					L2	L3	H	Q	W	
E984D-CAR	1/2	10	1 1/16	4 5/16	3 7/32	3 1/16	1 1/16	1 1/32	1 1/2	4.0
E984E	3/4	20	2 9/32	6 9/32	5 9/32	4 2 5/32	1 2 5/32	1 3/4	2 1/32	12.0
E984F-CAR	1	10	2 9/32	6 9/32	5 9/32	4 2 5/32	1 2 5/32	1 3/4	2 1/32	12.0
E984G	1 1/4	10	1 3/32	7 3 1/32	6 1 3/32	6	2 5/16	2 1/2	2 3/4	32.0
E984H	1 1/2	10	1 3/32	7 3 1/32	6 1 3/32	6	2 5/16	2 1/2	2 3/4	32.0
E984J	2	10	1 5/32	9 9/32	8 1 3/32	7 1/4	2 9/16	3 5/32	3 1 5/32	63.0

Diagram

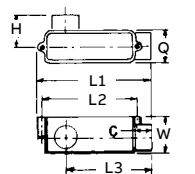

## Junction boxes

Molded nonmetallic junction boxes 6P rated



Nonmetallic junction boxes are CSA certified. Manufactured from PVC or PPO thermoplastic molding compound and featuring foam-in-place gasketed lids attached with stainless steel screws.

These rugged enclosures offer all the corrosion resistance and physical properties you need for direct burial applications.

These enclosures are NEMA 4-4x-6P rated.



Cat. no.	H x W x D (in.)	Std. ctn. qty.	Min. (in.)				Typical (in.)		Material		Std. ctn. wt. (lb)
			A <sub>T</sub>	A <sub>B</sub>	B	C	T <sub>B</sub>	T <sub>C</sub>	PVC	Thermoplastic	
E989NNJ	4 x 4 x 2	10	3 <sup>11</sup> / <sub>16</sub>	3 <sup>5</sup> / <sub>8</sub>	–	2	0.160	0.155	X		3
E989NNJ-CAR	4 x 4 x 2	8	3 <sup>11</sup> / <sub>16</sub>	3 <sup>5</sup> / <sub>8</sub>	–	2	0.160	0.155	X		3
E987N-CAR	4 x 4 x 4	10	3 <sup>11</sup> / <sub>16</sub>	3 <sup>1</sup> / <sub>2</sub>	–	4	0.160	0.155		X	4
E989PPJ	5 x 5 x 2	10	4 <sup>11</sup> / <sub>16</sub>	4 <sup>1</sup> / <sub>2</sub>	–	2	0.110	0.150		X	3
E987R	6 x 6 x 4	10	6	5 <sup>5</sup> / <sub>8</sub>	–	4	0.190	0.190		X	3
E989RRR-UPC	6 x 6 x 6	8	5 <sup>5</sup> / <sub>8</sub>	5 <sup>5</sup> / <sub>8</sub>	–	6	0.160	0.150		X	14
E989N-CAR	8 x 8 x 4	1	8	8	–	4	0.185	0.190		X	2
E989SSX-UPC	8 x 8 x 7	2	7 <sup>21</sup> / <sub>32</sub>	7 <sup>5</sup> / <sub>16</sub>	–	7	0.160	0.150		X	6
E989UUN	12 x 12 x 4	3	11 <sup>5</sup> / <sub>8</sub>	11 <sup>1</sup> / <sub>2</sub>	11 <sup>1</sup> / <sub>8</sub>	4	0.160	0.150		X	12
E989R-UPC	12 x 12 x 6	2	11 <sup>15</sup> / <sub>16</sub>	11 <sup>7</sup> / <sub>8</sub>	11 <sup>7</sup> / <sub>16</sub>	6	0.265	0.185		X	10

Diagrams

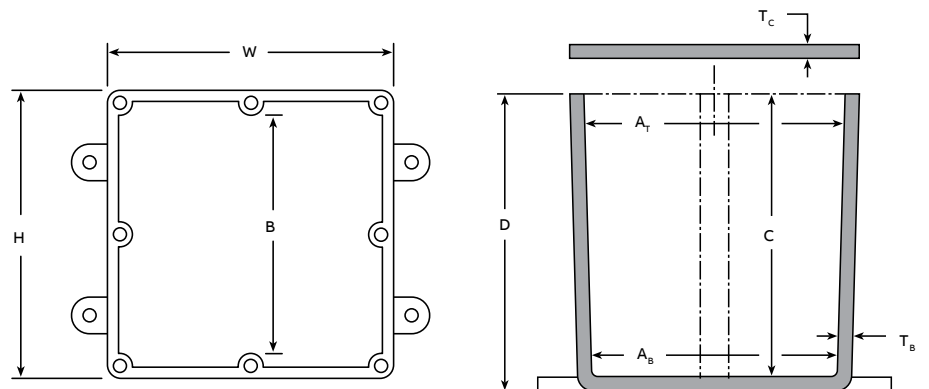



## Conduit sleeve couplings

Pass-through for concrete walls, columns and posts

**Carlson conduit sleeve couplings** are specifically designed for pass-through applications in concrete construction. They're manufactured from thermoplastic elastomer (TPE) so they're concrete-tight and flexible enough to mount to any surface. They can be mounted in vertical wall spans or angled wall spans up to 30° per side.

**Carlson conduit sleeve couplings** are fast and easy to install and can be immediately accessed or left dark until needed. They eliminate the need for duct tape, clamps and special mounting means while providing superior aesthetics by blending into the concrete.

### Applications

Concrete walls, columns and posts.

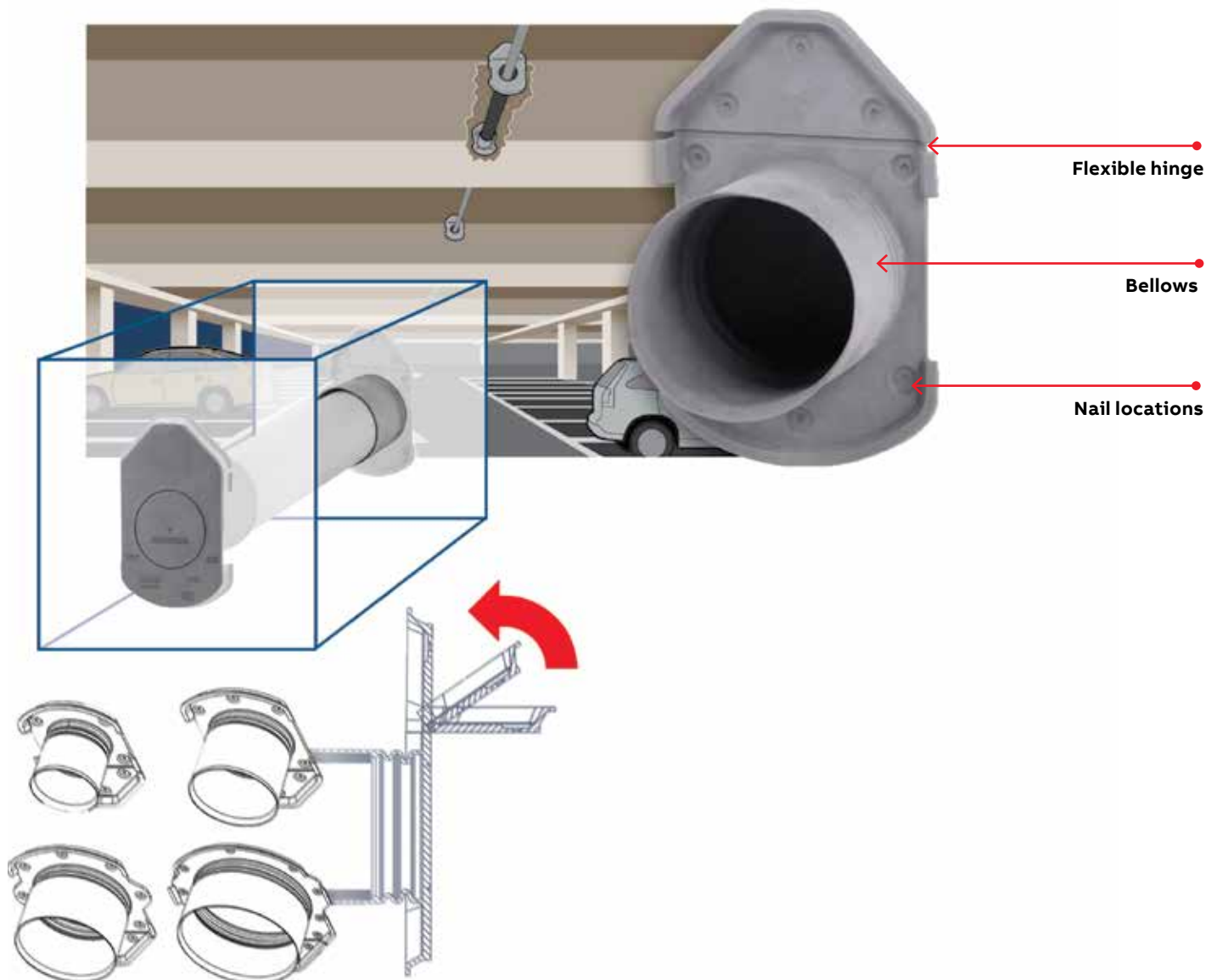

## Conduit sleeve couplings



### Features

- Exclusive
- Manufactured from TPE, concrete-tight
- Flexible hinge provides alignment of pass-through with ceiling
- Bellows – mounts to vertical walls and angled walls up to 30°
- Quick and easy installation

- Eliminates the use of duct tape and clamps
- Manufactured to IPS dimensions for use with most conduit types
- Superior aesthetics (blends in to the concrete)
- Trade sizes: 2 in., 3 in., 4 in. and 6 in.
- Future-proofs the structure – pass-through remains dark and protected until needed

Note: Firestop (where needed) and conduit not included

### Specifications

Cat. no.	Size (in.)	Std. ctn. qty.	Std. ctn. wt. (lb)
E992J	2	84	13.0
E992L	3	30	8.3
E992N	4	22	8.6
E992R	6	18	13.0

### Diagrams

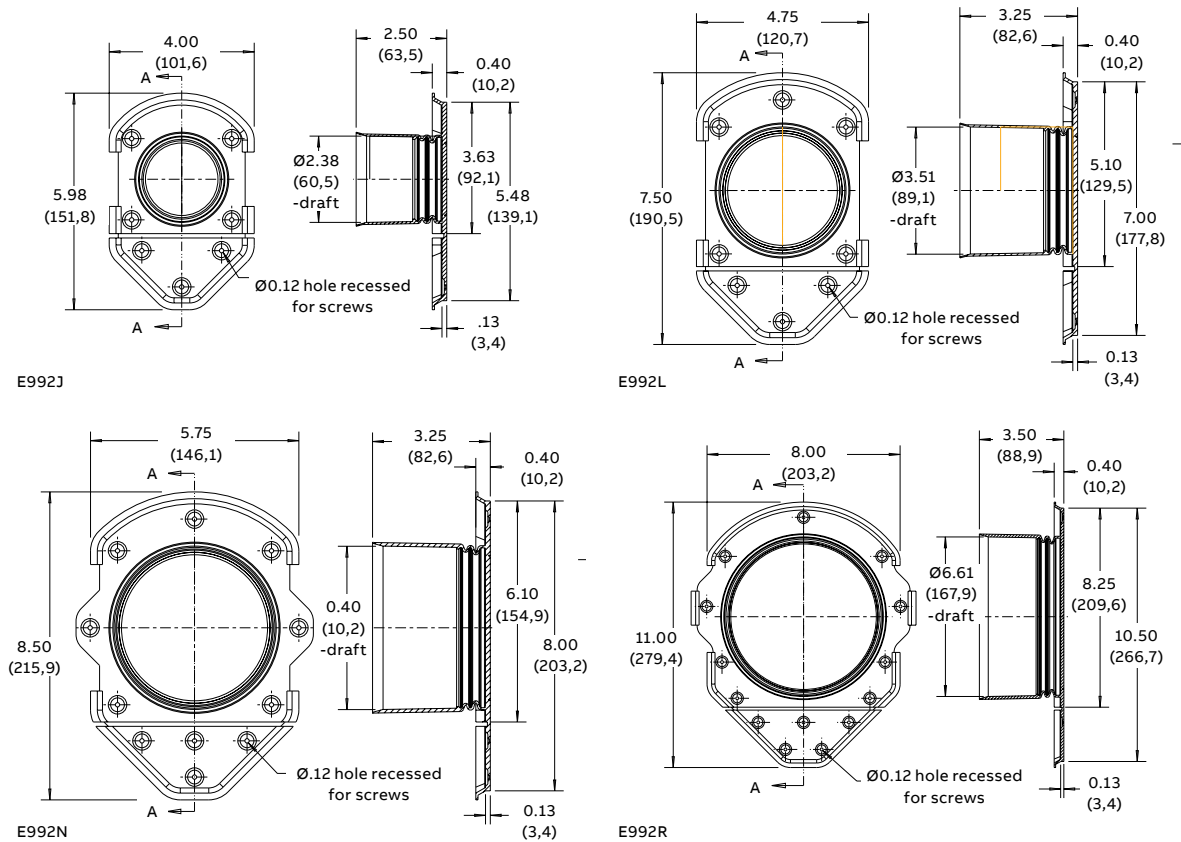

## Weatherproof nonmetallic boxes

### Nonmetallic weatherproof boxes



#### Type FSE single-gang box

- For dead-end terminations
- Mounting feet included
- 18 cu. in. volume
- Grounding strap included

FSEB-050



Cat. no.	Colour	Size (in.)	Std. ctn.
FSEB-050	Grey	½	12
FSEB-075	Grey	¾	12
FSEB-100	Grey	1	8



#### Type FSS single-gang box

- For multiple dead-end terminations or where additional support is required in stub-up applications
- Mounting feet included
- 18 cu. in. volume
- Grounding strap included

FSSB-050



Cat. no.	Colour	Size (in.)	Std. ctn.
FSSB-050	Grey	½	12
FSSB-075	Grey	¾	12
FSSB-100	Grey	1	8



#### Type FSC single-gang box

- For through terminations
- Mounting feet included
- 18 cu. in. volume
- Grounding strap included

FSCB-050



Cat. no.	Colour	Size (in.)	Std. ctn.
FSCB-050	Grey	½	12
FSCB-075	Grey	¾	12
FSCB-100	Grey	1	8



#### Type FSCC single-gang box

- For multiple through terminations or where additional support is required in stub-up applications
- Mounting feet included
- 18 cu. in. volume
- Grounding strap included

C979EFN



Cat. no.	Colour	Size (in.)	Std. ctn.
C979EFN	Grey	¾	15
C979FFN	Grey	1	15



#### Single-gang T box

- With three ½" threaded holes
- Mounting feet included
- Use with nonmetallic wiring systems only
- Grounding strap included
- Can be used with Red•Dot lampholder

WPB-T050-G



Cat. no.	Colour	Size (in.)	Std. ctn.
WPB-T050-G	Grey	½	8
WPB-T050-W	White	½	5

## Weatherproof nonmetallic boxes

### Nonmetallic weatherproof boxes



#### Type FDE single-gang deep box

- For dead-end terminations where large device or where additional support is required
- Mounting feet included
- 25 cu. in. volume
- Grounding strap included

C9801EN



Cat. no.	Colour	Size (in.)	Std. ctn.
C9801DN	Grey	½	10
C9801EN	Grey	¾	10

#### Diagrams

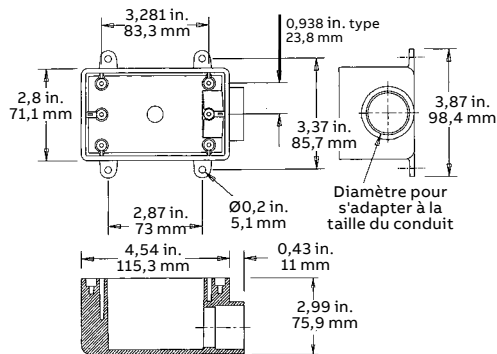

#### Type FDC single-gang deep box

- For through terminations where large device or where additional support is required
- Mounting feet included
- 25 cu. in. volume
- Grounding strap included

C9811EN



Cat. no.	Colour	Size (in.)	Std. ctn.
C9811EN	Grey	¾	10
C9811FN	Grey	1	10

#### Diagrams

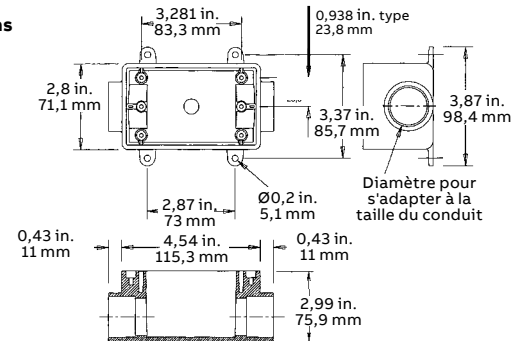

FDB-BLANK

#### Type FD single-gang deep box

- For terminations where hub requirements vary according to application
- Hubs can be added easily with flared wood bit or hole saw
- Mounting feet included
- 18 cu. in. volume
- Grounding strap included



Cat. no.	Colour	Size (in.)	Std. ctn.
FDB-BLANK	Grey	-	6

#### Diagrams

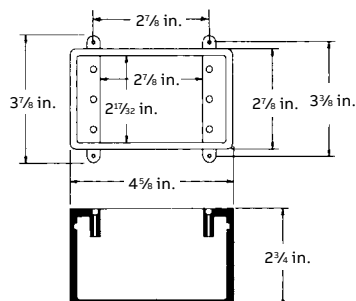

WPRB-T050-W

#### Round T box

- With five ½" threaded holes
- Mounting feet included
- Use with nonmetallic wiring systems only
- Grounding strap included
- Can be used with Red•Dot lampholder



Cat. no.	Colour	Size (in.)	Std. ctn.
WPRB-T050-G	Grey	½	8
WPRB-T050-W	White	½	8



WPRNDCV-G

#### Round T box flat cover

- Gasket included



Cat. no.	Colour	Std. ctn.
WPRNDCV-G	Grey	20
WPRNDCV-W	White	20

# Weatherproof nonmetallic boxes

## Nonmetallic weatherproof boxes



### Type FSE 2-gang box

- For dead-end terminations where two devices or additional capacity is required
- Mounting feet included
- 32 cu. in. volume
- Grounding strap included

FSEB2-075



Cat. no.	Colour	Size (in.)	Std. ctn.
FSEB2-050	Grey	½	5
FSEB2-075	Grey	¾	10
FSEB2-100	Grey	1	4

### Diagrams

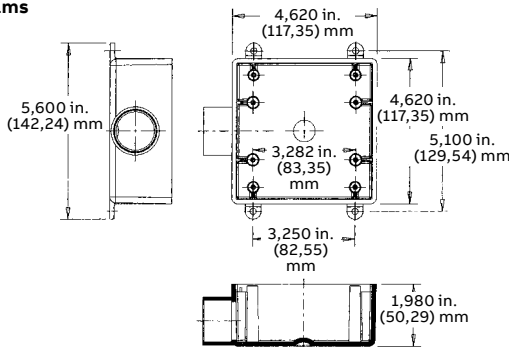

### Type FSC 2-gang box

- For through terminations where two devices or additional capacity is required
- Mounting feet included
- 32 cu. in. volume
- Grounding strap included

FSCB2-050



Cat. no.	Colour	Size (in.)	Std. ctn.
FSCB2-050	Grey	½	4
FSCB2-075	Grey	¾	10
FSCB2-100	Grey	1	10

### Diagrams

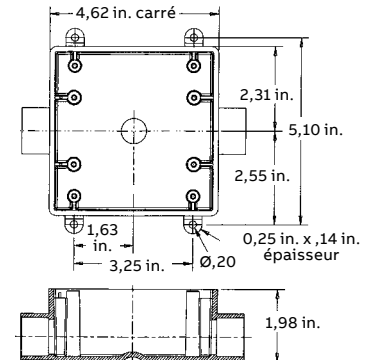

CE9802

### Type FS 2-gang box

- For terminations where hub requirements vary according to application
- Hubs can be added easily with flared wood bit or hole saw
- Mounting feet included
- 32 cu. in. volume
- Grounding strap included

Cat. no.	Colour	Size (in.)	Std. ctn.
CE9802	Grey	-	10

### Schémas

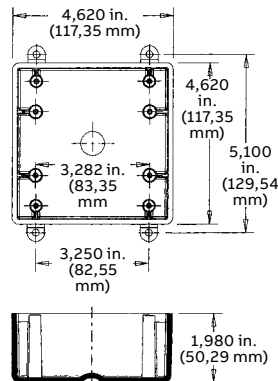

WPB2-T7550-G

### 2-Gang T box

- With three ½" and four ¾" threaded holes
- Mounting feet included
- Use with nonmetallic wiring systems only
- Grounding strap included
- Can be used with Red•Dot lampholder



Cat. no.	Colour	Size (in.)	Std. ctn.
WPB2-T7550-G	Grey	½-¾	6
WPB2-T7550-W	White	½-¾	6

## Weatherproof nonmetallic covers

### Single gang – Vertical mount

- For use in wet/damp locations
- Mounts to a box or device
- Nonmetallic
- Paintable
- Easy to install

#### Single gang – Vertical mount



	Cat. no.	Colour	Std. ctn.
<b>GFCI receptacle</b>			
	WPCV-GFI-V-G	Grey	10
	WPCV-GFI-V-W	White	10
	WPCV-GFI-V-B	Bronze	10

#### Duplex receptacle

	Cat. no.	Colour	Std. ctn.
	WPCV-DUP-V-G	Grey	10
	WPCV-DUP-V-W	White	10

#### 20-Amp receptacle

	Cat. no.	Colour	Std. ctn.
	E98G20N	Grey	20

For 20-amp or other single receptacle under 1.625" diameter

#### 50-Amp receptacle

	Cat. no.	Colour	Std. ctn.
	WPCV-50A-G	Grey	10

For 50-amp or other single receptacle under 2.25" diameter

#### Toggle switch

	Cat. no.	Colour	Std. ctn.
	WPCV-TOG-G	Grey	5
	WPCV-TOG-W	White	5



	Cat. no.	Colour	Std. ctn.
<b>Blank cover</b>			
	WPCV-BLK-G	Grey	12
	WPCV-BLK-W	White	12

Supplied with gasket and stainless steel mounting screw

#### 15-Amp receptacle

	Cat. no.	Colour	Std. ctn.
	WPCV-15A-G	Grey	10

For 15-amp or other single receptacle under 1.375" diameter

#### 30-Amp receptacle

	Cat. no.	Colour	Std. ctn.
	E98G30N-CAR	Grey	10

For 30-amp or other single receptacle under 1.75" diameter

#### Single switch

	Cat. no.	Colour	Std. ctn.
	WPCV-SSW-G	Grey	10

#### Plunger switch

	Cat. no.	Colour	Std. ctn.
	E98PSC	Grey	20

## Weatherproof nonmetallic covers

### Single gang – Horizontal mount and two-gang

- For use in wet/damp locations
- Mounts to a box or device
- Nonmetallic
- Paintable
- Easy to install

#### Single gang – Horizontal mount



	Cat. no.	Colour	Std. ctn.
<b>Duplex receptacle</b>			
	WPCV-DUP-H-G	Grey	10
	WPCV-DUP-H-W	White	10

#### GFCI receptacle

	Cat. no.	Colour	Std. ctn.
	WPCV-DUP-V-G	Grey	10
	WPCV-GFI-H-W	White	10
	WPCV-GFI-H-B	Bronze	10

#### Two-gang



	Cat. no.	Colour	Std. ctn.
<b>2-gang blank cover</b>			
	WPCV2-BLK-G	Grey	10

Supplied with gasket and stainless steel mounting screw

#### Combination toggle / GFCI

	Cat. no.	Colour	Std. ctn.
	WPCV2-GFISWG	Grey	3

#### Double toggle

	Cat. no.	Colour	Std. ctn.
	WPCV2-TOG-G	Grey	3

#### Double duplex receptacle

	Cat. no.	Colour	Std. ctn.
	WPCV2-DUP-G	Grey	10
	WPCV2-DUP-W	White	10

#### Combination toggle / duplex receptacle

	Cat. no.	Colour	Std. ctn.
	WPCV2-DUPSWG	Grey	10

## Weatherproof nonmetallic covers

Cover plates for indoor use only

### Single gang – Mount on box



	Cat. no.	Colour	Std. ctn.
--	----------	--------	-----------

#### Toggle switch

FSCV-SW-G	FSCV-SW-G	Grey	5
-----------	-----------	------	---



#### Duplex receptacle

FSCV-DUP-G	FSCV-DUP-G	Grey	5
------------	------------	------	---



### Single gang – Mount on device

	Cat. no.	Colour	Std. ctn.
--	----------	--------	-----------

#### Toggle switch

E98STSC	E98STSC	Grey	100
---------	---------	------	-----



### 2-gang – Mount on box



	Cat. no.	Colour	Std. ctn.
--	----------	--------	-----------

#### Double toggle switch

FSCV2-SW-G	FSCV2-SW-G	Grey	5
------------	------------	------	---



#### Double duplex receptacle

FSCV2-DUP-G	FSCV2-DUP-G	Grey	5
-------------	-------------	------	---





## Covers



**Single-gang**  
Fits single-gang FS boxes.  
Supplied with stainless steel mounting screws and gasket.



**Two-gang**  
Fits two-gang FS boxes,  
other nonmetallic and  
metallic FS boxes. Supplied  
with stainless steel mounting  
screws and gasket.

Cat. no.	Colour	Std. ctn. qty.	Std. ctn. wt. (lb)
E980CN-CAR	Grey	12	1.60
E980CM-CAR	White	12	1.60

Cat. no.	Colour	Std. ctn. qty.	Std. ctn. wt. (lb)
E9802CN-CAR	Grey	10	2.17
E9802CM-CAR	White	10	2.17

## Covers



**FS type duplex receptacle covers**  
For indoor use only. Gasket not included.



**FS type switch covers**  
For indoor use only. Gasket not included.



Cat. no.	Gang	Std. / inner qty.	Std. ctn. wt. (lb)
E98DGDR	2	150 / 5	0.75
E98SGDR	1	200 / 5	0.45

Cat. no.	Gang	Std. / inner qty.	Std. ctn. wt. (lb)
E98DTSCR	2	150 / 5	0.90
E98STSCR	1	200 / 5	0.55

## Support straps

### Snap Strap® conduit support straps



Carlson Snap Strap offers a unique support strap designed especially for the installation of PVC conduit. Also suitable for installations of rigid steel. This high strength, nonmetallic clamp allows conduit to expand and contract freely, eliminating the bowing commonly seen from the expansion and contraction of conduit caused by varying temperature changes. Finished installations have a neat, attractive appearance on exposed applications. To be used in accordance with conduit spacing requirements per Section 12-1114 of the CEC. This part is not supplied with screws.

- UV inhibited for use in direct sunlight

#### Single mount

Cat. no.	Size in. (mm)	Std. ctn. qty.	Std. ctn. wt. (lb)	Dimensions in. (mm)								
				A	B	C	D	F	G	H	J	R
E978DC-CAR	½ (16)	40	1	0.80 (20.3)	0.75 (1.90)	1.63 (41.4)	0.75 (19.1)	0.59 (14.9)	0.99 (25.1)	1.36 (34.5)	0.21 (5.33)	1.67 (42.4)
E978EC-CAR	¾ (21)	40	3	1.00 (25.4)	0.88 (22.4)	1.92 (48.7)	0.75 (19.1)	0.70 (17.8)	1.20 (30.4)	1.57 (39.9)	0.21 (5.33)	1.96 (49.8)
E978FC-CAR	1 (27)	30	4	1.20 (30.5)	1.02 (25.9)	2.17 (55.1)	0.75 (19.1)	0.83 (21.1)	1.43 (36.3)	1.84 (46.7)	0.21 (5.33)	2.22 (56.3)

#### Diagrams

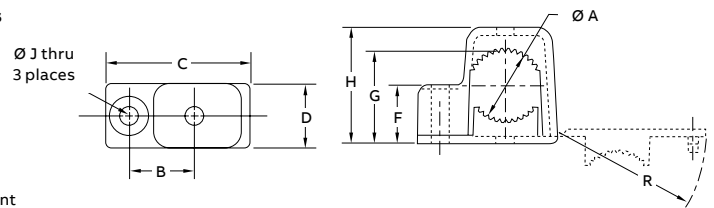

Single mount

#### Double mount

Cat. no.	Size in. (mm)	Std. ctn. qty.	Std. ctn. wt. (lb)	Dimensions in. (mm)								
				A	B	C	D	F	G	H	J	R
E978GCCAR	1¼ (35)	15	4	1.66 (42.16)	2.75 (69.9)	3.23 (82.0)	1.00 (25.4)	0.95 (24.1)	1.78 (45.2)	2.15 (54.61)	0.218 (5.54)	3.28 (83.3)
E978HCCAR	1½ (41)	15	5	1.92 (48.77)	3.05 (77.5)	3.53 (89.7)	1.00 (25.4)	1.08 (27.4)	2.04 (51.8)	2.40 (60.96)	0.218 (5.54)	3.58 (90.9)
E978JCCAR	2 (53)	10	5	2.34 (59.44)	3.50 (88.9)	4.00 (101.6)	1.00 (25.4)	1.31 (33.3)	2.48 (63.0)	2.86 (72.64)	0.218 (5.54)	4.06 (103.1)

#### Diagrams

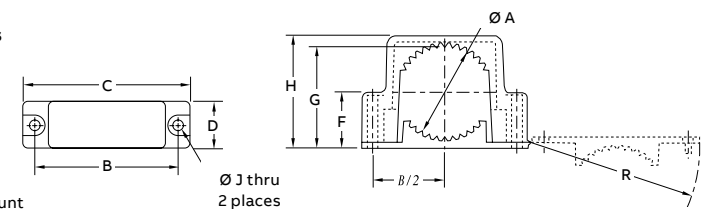

Double mount

## Clamps

### 2-Hole nonmetallic conduit clamps



Nylon masonry clamp

Nonmetallic clamps offer the same chemical resistance as Carlon nonmetallic conduit for a complete, corrosion-resistant system.

To be used in accordance with conduit spacing requirements per Section 12-1114 of the CEC.

- UV inhibited for use in direct sunlight

Cat. no.	Size in. (mm)	Std. ctn. qty.	Std. ctn. wt. (lb)	Dimensions in. (mm)								
				A	B	C	D	E	F	G	H	J
E977DC	½ (16)	100	1.2	0.892 (22.6)	1.71 (43.4)	2.16 (54.8)	0.50 (12.7)	0.14 (3.5)	0.42 (10.6)	0.866 (21.9)	1.04 (26.4)	0.260 (6.6)
E977EC	¾ (21)	100	1.4	1.102 (27.9)	1.97 (50.0)	2.40 (60.9)	0.50 (12.7)	0.14 (3.5)	0.525 (13.3)	1.076 (27.3)	1.255 (31.8)	0.260 (6.6)
E977FC	1 (27)	100	2	1.39 (35.3)	2.25 (57.1)	2.81 (71.3)	0.594 (15.0)	0.14 (3.5)	0.658 (16.7)	1.342 (34.0)	1.574 (39.9)	0.260 (6.6)
E977GC	1¼ (35)	50	5	1.714 (43.5)	2.68 (68.0)	3.28 (83.3)	0.64 (16.2)	0.15 (3.8)	0.83 (21.0)	1.687 (42.8)	1.89 (48.0)	0.320 (8.1)
E977HC	1½ (41)	50	6	1.92 (48.7)	2.82 (71.6)	3.44 (87.3)	0.70 (17.7)	0.15 (3.8)	0.97 (24.6)	1.93 (49.0)	2.12 (53.8)	0.312 (7.9)
E977JC	2 (53)	25	4.5	2.54 (64.5)	3.54 (89.9)	4.18 (106.1)	0.76 (19.3)	0.16 (4.0)	1.05 (26.6)	2.29 (58.1)	2.49 (63.2)	0.315 (8.0)
E977K*	2½ (63)	50	10	2.88 (73.0)	4.88 (123.8)	5.81 (147.7)	1.00 (25.4)	0.05 (1.3)	1.44 (36.5)	2.88 (73.0)	3.00 (76.1)	0.38 (9.5)
E977KC-CAR	2½ (63)	25	1.4	2.86 (72.6)	4.50 (114.3)	5.46 (138.7)	1.00 (25.4)	0.20 (5.08)	1.43 (36.3)	2.86 (72.6)	3.12 (79.2)	0.36 (9.14)
E977L*	3 (78)	25	5.0	3.38 (85.7)	5.72 (145.3)	6.88 (174.6)	1.00 (25.4)	0.05 (1.3)	1.66 (41.7)	3.34 (84.9)	3.47 (88.0)	0.38 (9.5)
E977LC-CAR	3 (78)	20	1.4	3.47 (88.2)	5.00 (127.0)	6.00 (152.4)	1.00 (25.4)	0.20 (5.08)	1.74 (44.3)	3.48 (88.4)	3.70 (94.0)	0.36 (9.14)
E977N*	4 (103)	15	3.0	4.75 (120.7)	7.52 (190.9)	8.77 (222.7)	1.25 (31.8)	0.12 (3.0)	1.94 (49.3)	4.38 (111.1)	4.50 (114.3)	0.50 (12.7)
E977NC-CAR	4 (103)	15	12.2	4.366 (110.9)	6.15 (156.2)	7.20 (182.9)	1.00 (25.4)	0.20 (5.08)	2.32 (58.8)	4.50 (114.3)	4.70 (119.4)	0.36 (9.14)
E977NDC-CTN**	½ (16)	12	1.2	-	-	-	-	-	-	-	-	-
E977NEC-CTN**	¾ (21)	12	1.3	-	-	-	-	-	-	-	-	-

#### Diagrams

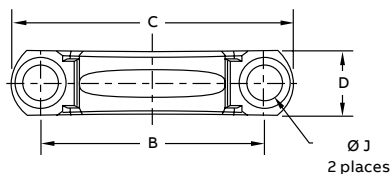

Conduit clamps

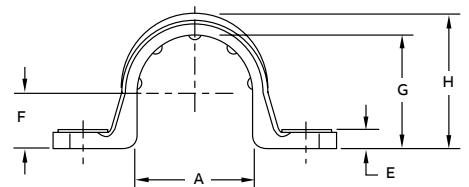

\* PVC-coated steel straps

\*\* Nylon masonry clamp

## General information

Typical properties of conduit raw material compound

Thermal	ASTM test	Typical values
Coefficient of thermal expansion-inch/inch/°C (properties at 23 °C)	D696	3.38 x 10-5
Heat distortion °C at 264 psi	D648	71 °C
Thermal conductivity BTU (hr.) (ft.) (°C/in.)	-	1.3

Electrical	ASTM test	Typical values
Dielectrical strength volts/mil	D149	1100
Dielectric constant 60 Hz @ 30 °C	D150	4.00
Power factor 60 Hz @ 30 °C	D150	1.93

Mechanical	ASTM test	Typical values
Specific gravity	D792	1.43-1.6
Tensile strength (psi) @ 23 °C	D638	5,000-6,500
Izod impact ft. lb/in. of notch	D256	0.65-1.5
Flexural strength (psi)	D790	12,500
Compressive strength (psi)	D695	9,000
Hardness (Durometer D)	D2240	85

Impedance (volts lost per ampere per 100 feet)	Ø3 90%		Ø1 90%	
	P.F.	P.F.	P.F.	P.F.
Steel conduit	0.0118	0.0123	0.0136	0.0142
Schedule 40	0.0105	0.0106	0.0121	0.0122

Using 250 kcmil copper conductor comparable values for other conductor sizes.

### Weight comparison

Carlton Schedule 40 rigid nonmetallic conduit compared to other rigid conduit in pounds per 100 feet (approx.)

Nom. size (in.)	Carlton Schedule 40 rigid nonmetallic conduit	Carlton Schedule 80 rigid nonmetallic conduit	Aluminum	Electrical metallic tubing (EMT)	Inter-mediate metal conduit (IMC)	Rigid metal conduit (RMC)
½	18	22	27	30	57	79
¾	23	29	36	46	78	105
1	35	43	43	66	112	153
1¼	48	60	70	96	114	201
1½	57	72	86	112	176	246
2	76	100	116	142	230	334
2½	125	153	183	230	393	527
3	164	212	239	270	483	690
3½	198		288	350	561	831
4	234	310	340	400	625	982
5	317	431	465	Not Made	Not Made	1344
6	412	592	612	Not Made	Not Made	1770

### Wire fill

Maximum number of conductors in Schedule 40 PVC conduit (based on Table 1, Chapter 9 of the NEC)

Type letters	Conductor size AWG, kcmil	Conduit trade size (in.)															
		½	¾	1	1¼	1½	2	2½	3	3½	4	4¼	5	6	8		
THWN	14	13	24	39	69	94	154										
	12	10	18	29	51	79	114	164									
THHN	10	6	11	18	32	44	73	194	160								
	8	3	5	9	19	22	36	51	71	106	136						
FEP (14 thru 2)	6	1	4	6	11	15	26	37	57	76	98	125	154				
	4	1	2	4	7	9	16	22	35	47	60	75	94	137	236		
FEPB (14 thru 4/0)	3	1	1	3	6	8	13	19	29	39	51	64	90	116	201		
	2	1	1	3	5	7	11	16	25	33	43	54	67	97	169		
PFA (14 thru 8)	1		1	1	3	5	9	12	18	25	32	49	59	72	125		
	1/0		1	1	3	4	7	10	15	21	27	33	42	61	105		
	2/0		1	1	2	3	6	8	13	17	22	29	35	51	88		
	3/0		1	1	1	3	5	7	11	14	18	23	29	42	73		
PFAH (14 thru 4/0)	4/050		1	1	1	2	4	6	9	12	15	19	24	35	61		
	250			1	1	1	3	4	7	10	12	16	20	28	49		
	300			1	1	1	3	4	6	8	11	13	17	24	42		
	350			1	1	1	2	3	5	7	9	12	15	21	37		
Z (14 thru 4/0)	400				1	1	1	3	5	6	8	10	13	19	33		
	500				1	1	1	2	4	5	7	9	11	16	27		
	600				1	1	1	1	3	4	5	7	9	13	22		
	700				1	1	1	1	3	4	5	6	8	11	19		
XHHW (4 thru 500)	750				1	1	1	2	3	4	6	7	11	19			
	6	1	3	5	9	13	21	30	47	63	81	102	128	185	320		
	600				1	1	1	1	3	4	5	7	9	13	22		
	700				1	1	1	1	3	4	5	6	7	11	19		
XHHW	750				1	1	1	2	3	4	6	7	10	18			

## General information

### Expansion and contraction

#### Temperature considerations for rigid nonmetallic conduit

##### Compensation for linear expansion

Like all construction materials, PVC will expand or contract with variations in temperatures. The coefficient of linear expansion in PVC conduit is  $3.38 \times 10^{-5}$  in./in./°C as compared to  $1.2 \times 10^{-5}$  for aluminum and  $0.6 \times 10^{-5}$  for steel. An expansion fitting is needed whenever the change in length due to temperature variation will be  $\frac{1}{4}$  in. or greater.

Add 1 °C to the estimated temperature range when conduit is installed in direct sunlight to allow for radiant heating. An expansion fitting consists of two sections, one telescoping inside another. When installing expansion fittings, alignment of piston and barrel is important. Be sure to mount expansion fitting level for best performance.

For a vertical run, the expansion fitting must be installed close to the top of the run with the barrel jointing down, in order that rain water does not run into the opening. The lower end of the conduit run must be secured at the bottom so that any length change due to temperature variation will result in an upward movement.

#### Expansion characteristics of PVC rigid nonmetallic conduit

Coefficient of thermal expansion =  $3.38 \times 10^{-5}$  in./in./°C

Temp. change in °F	Length change in inches per 100 ft. of PVC conduit	Temp. change in °C	Length change in inches per 100 ft. of PVC conduit	Temp. change in °C	Length change in inches per 100 ft. of PVC conduit	Temp. change in °C	Length change in inches per 100 ft. of PVC conduit
5	0.2	12.8	2.2	40.5	4.2	68.3	6.3
10	0.4	15.6	2.4	43.3	4.5	71.1	6.5
15	0.6	18.3	2.6	46.0	4.7	73.9	6.7
20	0.8	21.1	2.8	48.9	4.9	76.7	6.9
25	1.0	23.9	3.0	51.6	5.1	79.4	7.1
30	1.2	26.7	3.2	54.4	5.3	82.2	7.3
35	1.4	29.4	3.4	57.2	5.5	85.0	7.5
40	1.6	32.2	3.6	60.0	5.7	87.8	7.7
45	1.8	35.0	3.8	62.7	5.9	90.6	7.9
50	2.0	37.8	4.1	65.5	6.1	93.3	8.1

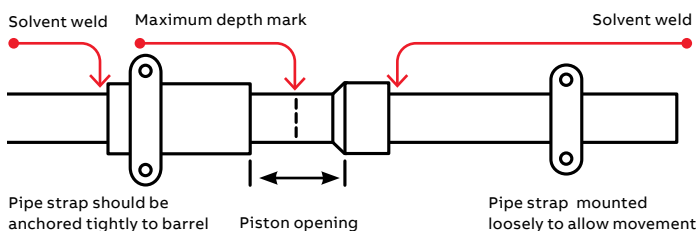

#### Determine the piston opening

The expansion joint must be installed to allow both expansion and contraction of the conduit run. The correct piston opening for any installation condition should use the following formula:

$$O = \left[ \frac{T_{\max} - T_{\text{installed}}}{\Delta T} \right] E$$

Where:

- O = Piston opening (in.)
- T max = Maximum anticipated temperature of conduit (°C)
- T inst. = Temperature of conduit at time of installation (°C)
- ΔT = Total change in temperature of conduit (°C)
- E = Expansion allowance built into each expansion fitting (in.)

#### Example

380 ft. of conduit is to be installed on the outside of a building exposed to the sun in a single straight run. It is expected that the conduit will vary in temperature from -17 °C in the winter to 60 °C in the summer (this includes the -1 °C for radiant heating from the sun). The installation is to be made at a conduit temperature of 32 °C. From the table, a 60 °C temperature change will cause a 5.7 in. length change in 100 ft. of conduit. The total change for this example is  $5.7 \text{ in.} \times 3.8 = 21.67 \text{ in.}$  which should be rounded to 22 in. The number of expansion fittings will be 22 in. x fitting range (4 in. for Carlon trade sizes  $\frac{1}{2}$  in. through  $1\frac{1}{2}$  in. and 8 in. for sizes 2 in. through 6 in.). If the E945D fitting is used, the number will be 22 in. x 4 = 5.50 which should be rounded to 6. The fitting should be placed at 62 ft. intervals (380 x 6). The proper piston setting at the time of installation is calculated as explained above.

$$O = \left[ \frac{60 \text{ °C} - 32 \text{ °C}}{60 \text{ °C}} \right] 4.0 = 1.4 \text{ in.}$$

Insert the piston into the barrel to the maximum depth. Place a mark on the piston at the end of the barrel. To properly set the piston, pull the piston out of the barrel to correspond to the 2.1 in. calculated above. See drawing at lower left.

#### Summary

1. Anticipate expansion and contraction of PVC conduit in above ground, exposed installation.
2. Use an expansion fitting when length change due to temperature variation will be  $\frac{1}{4}$  in. or greater.
3. PVC conduit expands 4.1 in. for each 100 feet of run and a 37.8 °C temperature change.
4. Align expansion fitting with the conduit run to prevent binding.
5. Follow the instructions to set the piston opening.
6. Rigidly fix the outer barrel of the expansion fitting so it cannot move. Mount the conduit connected to the piston loosely enough to allow the conduit to move as the temperature changes.

## General information

### Corrosion resistance of carlon schedule 40 PVC conduit and fittings

Carlton Schedule 40 is generally acceptable for use in environments containing the chemicals below. These environmental resistance ratings are based upon tests where the specimens were placed in complete submergence in the reagent listed. Schedule 40 can be used in many process areas where chemicals not on this list are manufactured or used

Acetic acid 0–20%	Bismuth carbonate	Copper sulfate	Hydrogen phosphide	Phenylhydrazine hydrochloride	Sodium chloride
Acetic acid 20–30%	Black liquor (paper industry)	Cottonseed oil	Hydrogen sulfide – dry	Phosgene, gas	Sodium cyanide
Acetic acid 30–60%	Bleach – 12.5% active $Cl_2$	Cresylic acid 50%	Hydrogen sulfide – aqueous solution	Phosphoric acid – 0–25%	Sodium dichromate
Acetic acid 80%	Borax	Crude oil – sour	Hydroquinone	Phosphoric acid – 25–50%	Sodium ferricyanide
Acetic acid – glacial	Boric acid	Crude oil – sweet	Hydroxylamine sulfate	Phosphoric acid – 50–85%	Sodium ferrocyanide
Acetic acid vapors	Brine	Demineralized water	Iodine	Photographic chemicals	Sodium fluoride
Acetylene	Bromic acid	Dextrin	Kerosene	Plating solutions	Sodium hydroxide
Adipic acid	Bromine – water	Dextrose	Lactic acid 28%	Potassium bicarbonate	Sodium hypochlorite
Alum	Butadiene	Diglycolic acid	Lauric acid	Potassium bichromate	Sodium nitrate
Aluminum chloride	Butane	Disodium phosphate	Lauryl chloride	Potassium bromide	Sodium nitrite
Aluminum fluoride	Butyl alcohol	Ethyl alcohol	Lauryl sulfate	Potassium carbonate	Sodium sulfate
Aluminum hydroxide	Butyl phenol	Ethylene glycol	Lead acetate	Potassium chromate	Sodium sulfide
Aluminum oxychloride	Butylene	Fatty acids	Lime sulfur	Potassium cyanide	Sodium sulfite
Aluminum nitrate	Butyric acid	Ferric chloride	Linoleic acid	Potassium dichromate	Sodium thiosulfate (hypo)
Aluminum sulfate	Calcium bisulfite	Ferric nitrate	Linseed oil	Potassium borate	Stannic chloride
Ammonia-dry gas	Calcium carbonate	Ferric sulfate	Lubricating oils	Potassium bromide	Stannous chloride
Ammonium bifluoride	Calcium chlorate	Ferrous chloride	Magnesium carbonate	Potassium chloride	Stearic acid
Ammonium carbonate	Calcium chloride	Ferrous sulfate	Magnesium chloride	Potassium chromate	Sulfur
Ammonium chloride	Calcium hydroxide	Fluorine gas – wet	Magnesium hydroxide	Potassium cyanide	Sulfur dioxide – gas dry
Ammonium hydroxide 28%	Calcium hypochlorite	Fluorine gas – dry	Magnesium nitrate	Potassium dichromate	Sulfur trioxide
Ammonium metaphosphate	Calcium nitrate	Fluoroboric acid	Magnesium sulfate	Potassium ferricyanide	Sulfuric acid – 0–10%
Ammonium nitrate	Calcium sulfate	Fluorosilicic acid	Maleic acid	Potassium ferrocyanide	Sulfuric acid – 10–75%
Ammonium persulfate	Carbonic acid	Formaldehyde	Malic acid	Potassium fluoride	Sulfuric acid – 75–90%
Ammonium phosphate – neutral	Carbon dioxide gas – wet	Formic acid	Mercuric chloride	Potassium hydroxide	Sulfurous acid
Ammonium sulfate	Carbon dioxide – aqueous solution	Fructose	Mercurous cyanide	Potassium nitrate	Tannic acid
Ammonium sulfide	Carbon monoxide	Gallic acid	Mercurous nitrate	Potassium perborate	Tanning liquors
Ammonium thiocyanate	Caustic potash	Gas – coke oven	Mercury	Potassium perchlorate	Tartaric acid
Amyl alcohol	Caustic soda	Gas – natural (dry)	Methyl sulfate	Potassium permanganate 10%	Titanium tetrachloride
Antraquinone	Chloroacetic acid	Gas – natural (wet)	Methylene chloride	Potassium persulfate	Triethanolamine
Antraquinonesulfonic acid	Chlorine gas (dry)	Gasoline – sour	Mineral oils	Potassium sulfate	Trimethyl propane
Antimony trichloride	Chlorine gas (moist)	Gasoline – refined	Naphthalene	Propene	Trisodium phosphate
Aqua regia	Chlorine water	Glucose	Nickel chloride	Propyl alcohol	Turpentine
Arsenic acid 80%	Chlorosulfonic acid	Glycerine (glycerol)	Nickel nitrate	Silicic acid	Urea
Arylsulfonic acid	Chrome alum	Glycol	Nitric acid, anhydrous	Silver cyanide	Vinegar
Barium carbonate	Chromic acid 10%	Glycolic acid	Nitric acid 20%	Silver nitrate	Whiskey
Barium chloride	Chromic acid 30%	Green liquor (paper industry)	Nitric acid 40%	Silver plating solutions	White liquor (paper industry)
Barium hydroxide	Chromic acid 40%	Heptane	Nitric acid 60%	Sodium acetate	Wines
Barium sulfate	Chromic acid 50%	Hexanol, tertiary	Nitrobenzene	Sodium arsenite	Zinc chloride
Barium sulfide	Citric acid	Hydrobromic acid 20%	Nitrous oxide	Sodium benzoate	Zinc chromate
Beet – sugar liquor	Copper chloride	Hydrochloric acid 0%–25%	Oils and fats	Sodium bicarbonate	Zinc cyanide
Benzene sulfonic acid 10%	Copper cyanide	Hydrochloric acid 25%–40%	Oils – petroleum – (see type)	Sodium bisulfate	Zinc nitrate
Benzoic acid	Copper fluoride	Hydrocyanic acid or hydrogen cyanide	Oleic acid	Sodium bisulfite	Zinc sulfate
	Copper nitrate	Hydrofluoric acid 10%	Oxalic acid	Sodium bromide	
		Hydrofluorosilicic acid	Palmitic acid 10%	Sodium chlorate	
			Perchloric acid 10%		

because worker safety requirements dictate that any air presence or splashing be at a very low level.

If there are any questions for specific suitability in a given environment, prototype samples should be tested under actual conditions.

## DB/2 PVC conduit

Rigid type DB/2 PVC conduit



### Physical properties by ASTM test methods

Carlton Type DB/2 PVC conduit is designed for use in concrete encased or masonry and direct burial applications. Type DB/2 PVC is CSA certified, tested to CSA Standard C22.2 No. 211.1

Properties	ASTM No.	Typical values type DB/2 conduit
Tensile strength, psi	D638	4,800
Modulus of elasticity in tension, psi	D638	500,000
Flexural strength, psi	D790	11,000
Deflection temp under load at 265 psi deg. C	D648	72 °C
Coefficient of thermal expansion in./in./°C	D696	3.30 x 10 <sup>-5</sup>
Maximum coefficient of static friction		0.20

### Performance properties of type DB/2 conduit

as indicated under CSA Standard C22.2 No. 211.1

#### Pipe Stiffness kPA

Conduit series	Min. pipe stiffness (FΔy), all sizes
DB/2	200

#### Minimum impact resistance (J)

Conduit series	-18 °C	23 °C
DB/2	34	61

Cat. no. 10'	Cat. no. 20'	Nom. size (in.)	Std. crate only		Approx. wt. Per 100 ft.		Average outside diameter		Average wall thickness	
			10 ft.	20 ft.	(lb)	(kg)	(in.)	(mm)	(in.)	(mm)
48811CPD-010	48811CPD-020	2	2,460	4,920	35	15.9	2.25	57.15	0.070	1.78
48813CPD-010	48813CPD-020	3	1,120	2,240	58	26.3	3.25	82.55	0.080	2.03
48815CPD-010	48815CPD-020	4	630	1,260	100	45.4	4.22	107.08	0.106	2.69
48816CPD-010	48816CPD-020	5	430	860	180	81.6	5.30	134.60	0.150	3.81
48817CPD-010	48817CPD-020	6	280	560	220	99.8	6.27	159.38	0.155	3.94

Also available in orange, add OG after CPD to the cat. no.

Also available in red. Add RD after CPD in the cat. no.





## DB/2 duct fittings

### PE coupling – Push fit



	Cat. no.	Size (in.)	Std. ctn. qty.
	CE242J	2	24
	CE242L	3	100
	CE242N	4	25
	CE242P	5	12
	CE242R	6	6

### PVC 5° coupling BxB – Solvent weld



	Cat. no.	Size (in.)	Std. ctn. qty.
	CE245J	2	30
	CE245L	3	15
	CE245N	4	15
	CE245P	5	20
	CE245R	6	1

### PVC 5° coupling – Push fit



	Cat. no.	Size (in.)	Std. ctn. qty.
	CE2440L	3	100
	CE2440N	4	100
	CE2440P	5	45

### Plugs with pull tab



	Cat. no.	Size (in.)	Std. ctn. qty.
	P258JT	2	60
	P258LT	3	30
	P258NT	4	48
	P258PT	5	30
	P258RT	6	30

### End bells (for use with DB/2 duct only)



	Cat. no.	Size (in.)	Std. ctn. qty.
	CE297J	2	40
	CE297L	3	30
	CE297N	4	20
	CE297P	5	15
	CE297R	6	1

### PVC coupling – Solvent weld



	Cat. no.	Size (in.)	Std. ctn. qty.
	CE240J	2	50
	CE240L	3	20
	CE240N	4	25
	CE240P	5	20
	CE240R	6	6

### PVC female adapter – IPS solvent weld duct



	Cat. no.	Size (in.)	Std. ctn. qty.
	CE942DJ	2	25
	CE942DL	3	30
	CE942DN	4	50
	CE942DP	5	15
	CE942DR	6	6

### PVC conduit to DB/2 duct adapter



	Cat. no.	Size (in.)	Std. ctn. qty.
	CE942RJ	2	100
	CE942RL	3	30
	CE942RN	4	20
	CE942RP	5	20

### Cap – Solvent weld



	Cat. no.	Size (in.)	Std. ctn. qty.
	CE935J	2	25
	CE935L	3	25
	CE935N	4	50
	CE935P	5	25
	CE935R	6	25

## DB/2 sweeps



Cat. no.	Size (in.)	Radius (in.)	Std. ctn. qty.
CPF9DJ-PD	2	24	1
CPF9DL-PD	3	24	1
CPF9DN-PD	4	24	1
CPF9DP-PD	5	24	1
CPF9FJ-PD	2	36	1
CPF9FL-PD	3	36	1
CPF9FN-PD	4	36	1
CPF9FP-PD	5	36	1
CPF9FR-PD	6	36	1
CPF9GP-PD	5	42	1
CPF9IJ-PD	2	60	1
CPF9IL-PD	3	60	1
CPF9IN-PD	4	60	1
CPF9IP-PD	5	60	1
CPF9IR-PD	6	60	1
CPF9BJO-PD	2	12	1
CPF9FJO-PD	2	36	1
CPF9FLO-PD	3	36	1
CPF9FNO-PD	4	36	1

Diagram

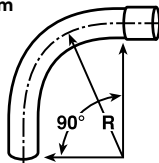

90° sweep

Cat. no.	Size (in.)	Radius (in.)	Std. ctn. qty.
CPF7DJ-PD	2	24	1
CPF7DL-PD	3	24	1
CPF7DN-PD	4	24	1
CPF7FJ-PD	2	36	1
CPF7FL-PD	3	36	1
CPF7FN-PD	4	36	1
CPF7FR-PD	6	36	1
CPF7GP-PD	5	42	1
CPF7IN-PD	4	60	1
CPF7IP-PD	5	60	1
CPF7IR-PD	6	60	1

Diagram

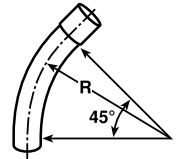

45° sweep

Cat. no.	Size (in.)	Radius (in.)	Std. ctn. qty.
CPF5DJ-PD	2	24	1
CPF5DL-PD	3	24	1
CPF5DN-PD	4	24	1
CPF5FL-PD	3	36	1
CPF5FN-PD	4	36	1
CPF5GP-PD	5	42	1
CPF5IN-PD	4	60	1

Diagram

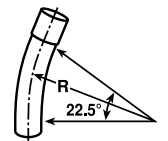

22-1/2° sweep

## Bore-Gard

### PVC trenchless raceway

The unique design incorporates a proprietary water-tight seal and locking ring that enables fast, cement-free assembly, strong enough for 1000 foot bores.

#### Benefits

- Lower overall installed cost – simpler handling, faster assembly, lower labour cost
- Lower freight cost
- Greater internal fill capacity – Bore-Gard does not distort into an oval during spooling
- No wasted product
- Easier to transport, especially over rough terrain – one length of Bore-Gard can be carried by one person
- Strong and flexible for directional drilling

applications

- Use standard PVC fittings – Bore-Gard is made using standard Schedule 40 dimensions – can be cemented
- No reel handling equipment required – Bore-Gard can be unloaded by hand
- No fusion splicing equipment required to join two pipe sections – Bore-Gard is joined together by one person
- No costly reels to return – with Bore-Gard, there are no reels to handle

—  
01 Trim spigot end before attaching pulling eye.

—  
02 Tighten pulling eye so that it expands against interior of the conduit.

—  
03 Attach the next piece of Bore-Gard.



—  
01



—  
02



—  
03

#### Assembly

1. Position Bore-Gard with the print line facing up.
2. Remove plastic locking strap and set it aside.
3. Remove end caps. On first stick only, trim spigot end of Bore-Gard at the groove before attaching the pulling eye/gripping attachment.
4. Insert pulling eye into spigot end of Bore-Gard.
5. Tighten pulling eye so that it expands against the interior of the conduit. Use of sleeve over O.D. of conduit is recommended.
6. The installer should use appropriate instrumentation to ensure that maximum pull rating is not exceeded.
7. Take next piece of Bore-Gard (10' or 20') and insert spigot end into belled end of the first piece until the insertion line is no longer visible.
8. Slide the plastic locking strap into slot on the side of the bell. Push the strap in completely. It is not necessary to remove or cover the handle on the strap.
9. Repeat with remaining sections as space allows.
10. Bore-Gard is now ready for installation.

# Bore-Gard

## PVC trenchless raceway

01 Minimum bend radius: Turns in a bore path should be made gradually. Bore-Gard and boreable Multi-Gard have a minimum bend radius of 65'. Bending more than this recommended limit will stress the joint. The drawing on the left illustrates the 65' bend radius. To obtain a 90° turn, you will require 65' of forward distance in any directional plane.

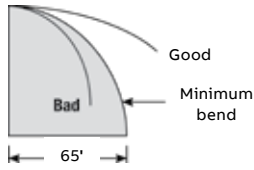

01

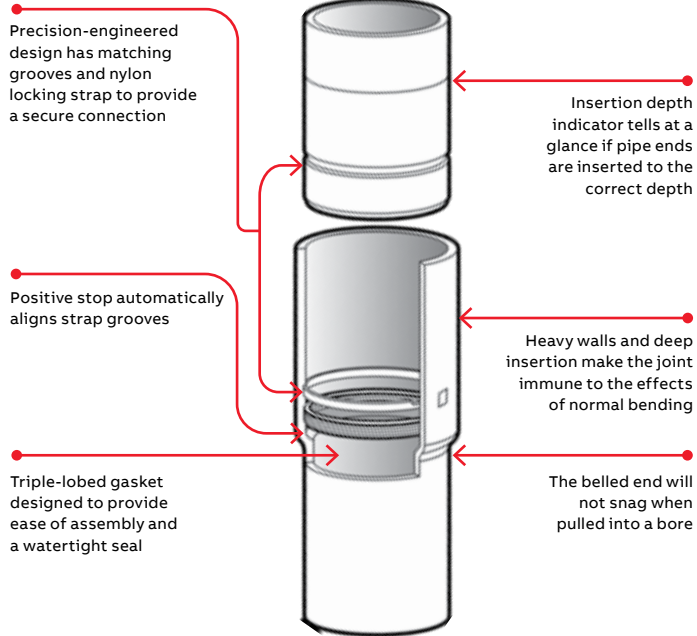

### Technical information

Axial tensile rating	3 in. - 7,000 pull-apart rating 4 in. - 8,700 pull-apart rating 5 in. - 11,300 pull-apart rating 6 in. - 14,000 pull-apart rating
Minimum bend radius	65 feet – assembly force 20 lb
Seal pressure rating	75 psi
Stiffness rating	600 lb/in. @ 5% defl.
Lengths	10 ft. and 20 ft.
Restrained joint in bell	Locking ring/ groove design



Cat. no.	Description	Overall length (ft.)	Lay length	O.D. (in.)	I.D. (in.)	Pkg. qty (ft./bundle)	Bundles per truckload	Feet per truckload	Wt. per 100 ft. (lb)	Min. bend radius (ft.)	Insertion force (lb)	Seal pressure rating (psi)	Joint pull rating (lb)	Typical crush rating (lb) (@ 30% deflection)	NEMA TC2 min. crush (lb)
BG340SP-010	3 in. Sch. 40	10	9'6"	3.50	3.0	350	56	19,600	164	65	20	75	7,000	1,225	1,000
BG340SP-020	3 in. Sch. 40	20	19'6"	3.50	3.0	700	28	19,600	164	65	20	75	7,000	1,225	1,000
BG440SP-010	4 in. Sch. 40	10	9'6"	4.50	4.0	260	56	14,560	234	65	40	75	8,700	1,075	900
BG440SP-020	4 in. Sch. 40	20	19'6"	4.50	4.0	520	28	14,560	234	65	40	75	8,700	1,075	900
BG540SP-010	5 in. Sch. 40	10	9'6"	5.56	5.0	230	40	9,200	317	65	60	75	11,300	950	900
BG540SP-020	5 in. Sch. 40	20	19'6"	5.56	5.0	460	20	9,200	317	65	60	75	11,300	950	900
BG640SP-010	6 in. Sch. 40	10	9'6"	6.625	6.0	200	40	8,000	418	65	80	75	14,000	950	900
BG640SP-020	6 in. Sch. 40	20	19'6"	6.625	6.0	400	20	8,000	418	65	80	75	14,000	950	900

## Multi-Gard

PVC boreable conduit

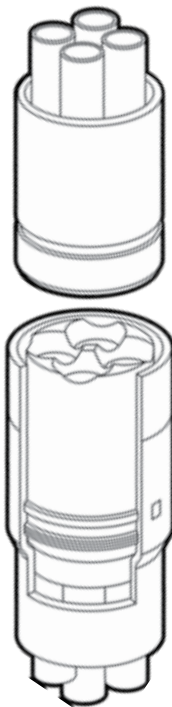

### Benefits

- Withstands pulling and bending forces of directional drilling
- Fast assembly
- Eliminates labor related to gluing and screwing joints together
- For bores up to 500 feet
- Innerducts: 3-way or 4-way
- Easy to handle 20-foot lengths
- Type: Type 40 PVC outerduct
- Size: 4 in.
- Prelubricated innerducts
- Strong water-tight joints without cement
- Fits standard Schedule 40 fittings
- Compatible with Multi-Gard Type 40 PVC products

Cat. no.	Description	Length (ft.)	O.D. (in.)	Innerduct I.D. (in.)	Pkg. qty (ft./ bundle)	Bundles per truckload	Feet per truckload	Wt. per 100 ft. (lb)	Min. bend radius (ft.)	Seal pressure rating (psi)	Max. pull rating (lb)
MFSS3B-020	3-way Boreable Multi-Gard	20	4.50	1.50	520	28	14,560	561	65	75	5,000
MFSS4B-020	4-way Boreable Multi-Gard	20	4.50	1.19	520	28	14,560	565	65	75	5,000

## Split duct

### Product overview

01 The fast and easy method of installing duct around existing cable for repair and temporary installations.



01

Split duct is the fast and easy way to repair broken ductwork without the costly cutting and resplicing of your conductors.

Our unique tongue-and-groove design leads the industry in providing a strong, rigid solution for duct repair situations.

The interlocking design allows the split duct sections to be staggered and butted together. Joints may be sealed with tape and reinforced with plastic or metallic straps to produce a rigid, stable unit.

Manufactured from a compound designed specifically for power and telecommunications applications, split duct exhibits superior impact strength.

Available in 2 in. through 6 in. diameters, this product line also contains couplings and sweeps necessary to complete the system.

Verify with local inspection authorities before using.

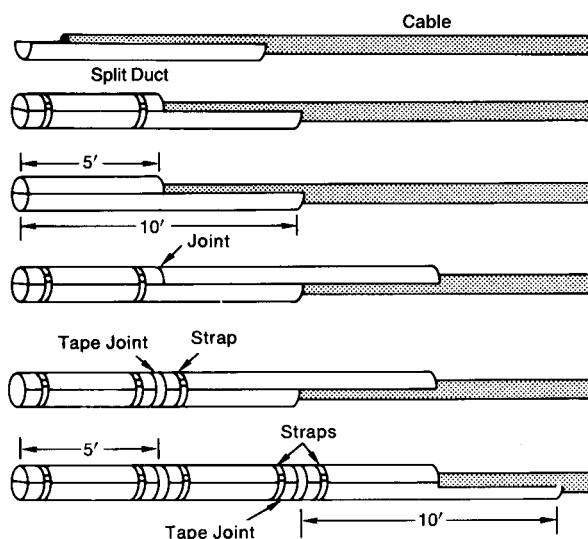

#### Recommended installation procedure

1. Place one 10-foot split duct section under cable.
2. In order to stagger joints, saw another section in half (about 5 feet long).
3. Place 5-foot section over cable and snap the two sections together.
4. Place strap about one foot from the end and another strap about a foot from the joint where the ends of the top sections will butt.
5. Place another 10-foot split duct section over the open half of the bottom section, butt the ends tightly together and snap the sections together.
6. Place a length of tape around both sections of the split duct to cover the butted joint.
7. Place a strap about one foot beyond the taped joint.
8. Lay another length of split duct underneath cable, butt together, tape the butted joint and strap one foot on each side of the joint.
9. Repeat procedure.

## Split duct

### Split duct



Cat. no.	Size (in.)	Std. ctn. qty.	Std. ctn. wt. (lb)	O.D. (in.)
<b>Schedule 40</b>				
49011SD-010	2	700	523	2.375
49012SD-010	2½	460	562	2.875
49013SD-010	3	500	802	3.500
49014SD-010	3½	290	560	4.000
49015SD-010	4	290	662	4.500
49016SD-010	5	130	718	5.563
49017SD-010	6	130	523	6.625
<b>Schedule 80</b>				
49411SD-010	2	700	702	2.375
49415SD-010	4	290	890	4.500
<b>C duct</b>				
68515SD-010	4	320	614	4.350

### Split sleeve coupling



Cat. no.	Size (in.)	Length (in.)	Split	Std. ctn. qty.	Std. ctn. wt. (lb)
<b>Schedule 40 and 80</b>					
E200JS6	2	6	1	25	6.1
E200KS7	2½	7	1	25	21
E200LS7	3	7	1	25	15.5
E200LSS	3	6½	1	25	10
E200MS8	3½	8	1	25	41.2
E200NS8	4	8	1	15	16
E200NSS	4	6	1	25	17
E200PS8	5	8	1	15	25
E200PS9	5	9	1	8	16.4
E200RS1	6	10	1	6	24.2
<b>C duct</b>					
E900NS8 (white)	4	8	1	15	19
E900NSW (white)	4	6	1	25	22

### Split sleeve sweeps



Cat. no.	Nom. size (in.)	Radius (in.)	Std. ctn. qty.	Std. ctn. wt. (lb)
<b>45° Sweep</b>				
UA7DJSD	2	24	1	1.4
UA7FJSD	2	36	1	2.1
UA7FLSD	3	36	1	4.7
UA7HJSD	2	48	1	2.7
UA7HLSD	3	48	1	6.1
UA7IJSD	2	60	1	3.2
UA7ILSD	3	60	1	7.2
UA7INSD	4	60	1	10.2
<b>22½° Sweep</b>				
UA5INSD	4	60	1	6.1
<b>11¼° Sweep</b>				
UA3IJSD	2	60	1	1.0
UA3ILSD	3	60	1	3.6
UA3INSD	4	60	1	5.1

Two 45° elbows may be segmented for 90°.

## Split kits

### Product overview



Split kits are specifically designed to make Schedule 40 and Type C conduit repairs faster and easier. Damaged conduit can be repaired without disturbing the installed wire/cable system. Split kits come in handy 2 feet lengths with 7 inch split couplings on each end. UV-resistant for outdoor use, split kits feature the same durable tongue-and-groove design as our split duct product.

Split kits are manufactured from extra-rugged PVC material. The unique design maintains the same physical performance and dimensional characteristics as the PVC pipe it is repairing. No other repair product can make this offer.

The reason is in the interlocking/tongue-and-groove design that holds the true dimensions of the product, both I.D. and O.D., while maintaining the pipe's physical performance characteristics too.

Verify with local inspection authorities before using.

### Split kits...

Conduit repairs made faster and easier.



#### Features

- Interlocking/tongue-and-groove design to assure dimensional pipe characteristics
- Convenient and handy for easy handling, transport and storage
- 2 ft. lengths for fast/easy conduit repairs eliminates the need for cutting standard 10 ft. lengths to size – get off the jobsite faster.
- Two 7 in. split couplings for a secure fit allows the product to be coupled together for longer repairs; solvent cementable = water-resistant
- Available in two wall types – Schedule 40 (sizes 2 in. through 6 in.), and Type C (4 in.)
- Manufactured from extra-rugged PVC – lightweight, solvent cementable and compatible with all standard pipe fittings



# Split kits



## Specifications

Cat. no.	Size (in.)	Wall type	Std. ctn. qty.	Std. ctn. wt. (lb)
SK4020	2	Schedule 40	10	24.3
SK4025	2½	Schedule 40	10	49.2
SK4030	3	Schedule 40	8	43.6
SK4040	4	Schedule 40	5	40.5
SK4050	5	Schedule 40	3	34.6
SK4060	6	Schedule 40	2	36.4
SKC40	4	Type C	5	36.2

## Diagrams

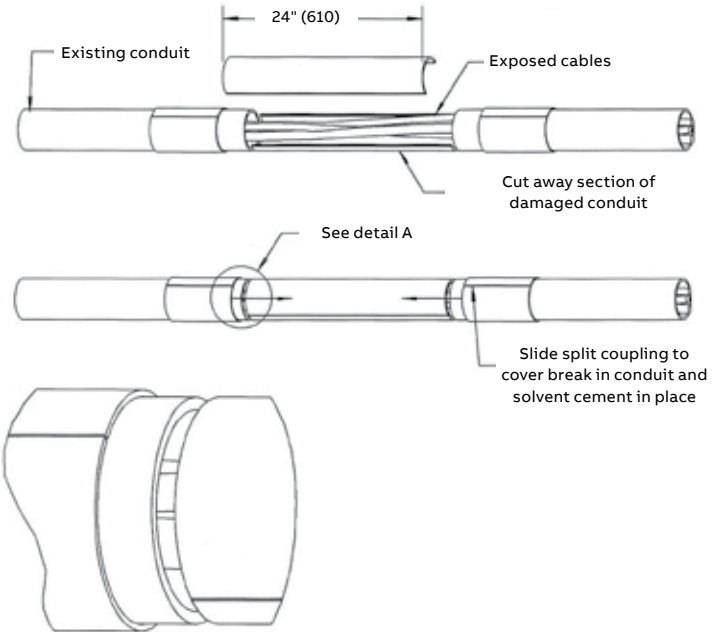

Detail A  
scale 0.500

## Snap-Loc spacers

### Product overview



Carlton Snap-Loc duct spacers provide stability, consistent separation and relieve direct stress for duct materials encased in concrete and direct burial applications.

Carlton Snap-Loc spacers provide:

- A side dovetail rail-and-groove design allowing for side-by-side interchangeability of conduit spacer sizes while maintaining horizontal stability.
- Locking key ways incorporated into intermediate spacers eliminate the need for costly top spacers in each size. The locking key ways provide for the use of a beaded strap that secures the top section of conduit.
- 1 in. and 2 in. Snap-Loc reducers allow fixturing of 1 in. or 2 in. conduit inside larger spacers.
- The Snap-Loc rebar holder provides stabilization on large banks of spacers.

Nonmetallic Snap-Loc spacers are designed specifically for use with nonmetallic duct, with maximum O.D. dimensions as specified in NEMA TC-2, TC-6 and 8, TC-10 and ASTM F512. The innovative vertical and horizontal interlocking Snap-Loc design has tapered joining slots with maximum tolerances for easy job site assembly.

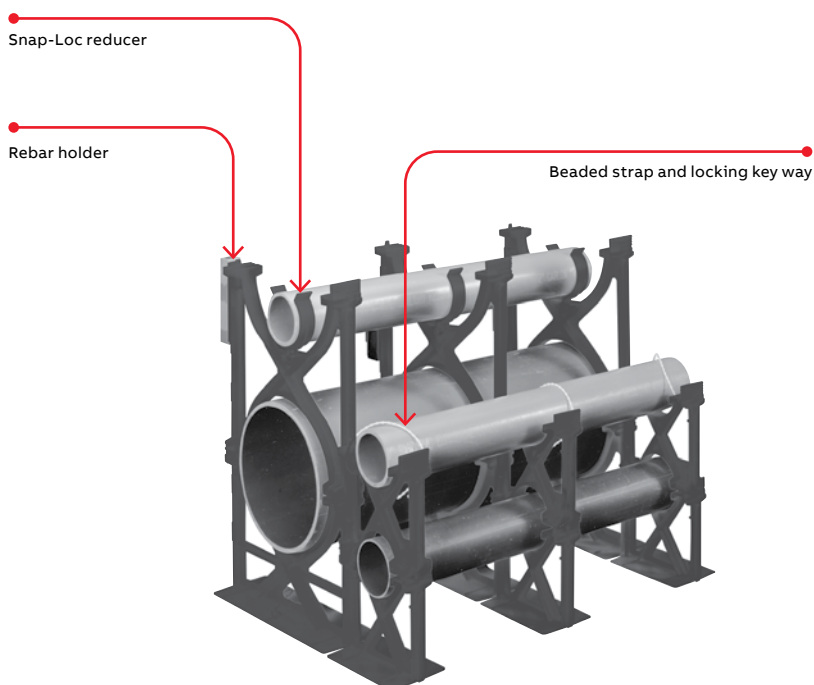

#### Important

1. The use of duct spacers for direct burial may result in excessive point deflections unless proper design engineering is applied, such as the proper compaction of the appropriate backfill material.
2. ABB is not responsible for Snap-Loc spacers used in direct burial applications; design engineers and contractors are responsible for the design of the installation.

## Snap-Loc spacers

### Dimensions – Base spacers

Cat. no.	Size* (in.)	A (in.)	C (in.)	Dia. (in.)	D	Std. ctn. qty.
S288JHN	2 x 1½	4.25	4.12	2.50		100
S288JJN	2 x 2	4.25	4.62	2.50		100
S288JLN	2 x 3	4.25	5.62	2.50		100
S288LHN	3 x 1½	4.81	5.25	3.63		90
S288LJN	3 x 2	4.81	5.75	3.63		80
S288LLN	3 x 3	4.81	6.75	4.63		60
S288NFN	4 x 1	4.50	6.75	4.63		70
S288NHN	4 x 1½	5.31	6.25	4.63		50
S288NJN	4 x 2	5.31	6.75	4.63		50
S288NLN	4 x 3	5.31	7.75	5.69		60
S288PHN	5 x 1½	5.84	7.31	5.69		50
S288PJN	5 x 2	5.84	7.81	5.69		60
S288PLN	5 x 3	5.84	8.81	6.75		50
S288RHN	6 x 1½	6.38	8.38	6.75		50
S288RJN	6 x 2	6.38	8.88	6.75		50
S288RLN	6 x 3	6.38	9.88	6.75		40
S288SHN	8 x 1½	7.38	10.30	8.75		30
S288SJN	8 x 2	7.38	10.76	8.75		30

### Dimensions – Intermediate spacers

Cat. no.	Size* (in.)	A (in.)	C (in.)	Dia. (in.)	D	Std. ctn. qty.
S289JHN	2 X 1½	3.88	4.12	2.50		100
S289JJN	2 x 2	4.38	4.62	2.50		100
S289JLN	2 x 3	5.38	5.62	2.50		100
S289LHN	3 x 1½	5.01	5.25	3.63		90
S289LJN	3 x 2	5.51	5.75	3.63		80
S289LLN	3 x 3	6.51	6.75	4.63		60
S289NFN	4 x 1	5.51	6.75	4.63		70
S289NHN	4 x 1½	6.01	6.25	4.63		50
S289NJN	4 x 2	6.51	6.75	4.63		50
S289NLN	4 x 3	7.51	7.75	5.69		60
S289PHN	5 x 1½	7.07	7.31	5.69		50
S289PJN	5 x 2	7.57	7.81	5.69		60
S289PLN	5 x 3	8.57	8.81	6.75		50
S289RHN	6 x 1½	8.14	8.38	6.75		50
S289RJN	6 x 2	8.64	8.88	6.75		50
S289RLN	6 x 3	9.64	9.88	6.75		40
S289SHN	8 x 1½	10.14	10.30	8.75		30
S289SJN	8 x 2	10.64	10.76	8.75		30

### Diagram

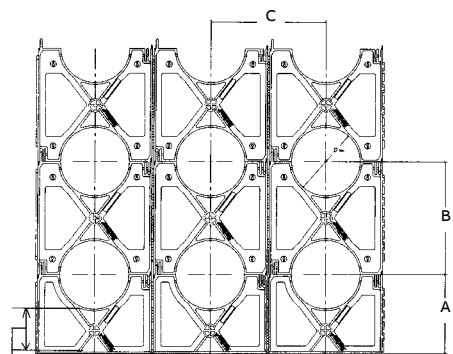

3 in. standard for all base spacers (with the exception of the 4X1-S288NFN)

\*First number indicates trade size of duct, second number indicates separation between conduit or ducts.

## Snap-Loc spacers

### Accessories

#### Snap-Loc reducer

Cat. no.	Size (in.)	Std. ctn. qty.
S287F	1	100
S287J	2	100

Diagram

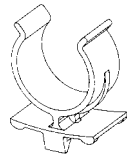

#### Rebar holder

Cat. no.	Std. ctn. qty.
S258RH	100

Diagram

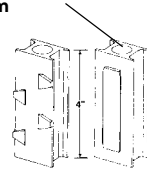

Hole dia. 0.688" min.  
and 0.750" max.

#### Beaded strap

Cat. no.	Std. ctn. qty.
S28612	1 Bag of 250

Diagram

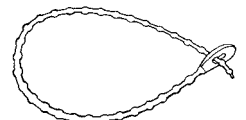

15 in. in length

### Specifications

#### Suggested specification

(Duct) (Conduit) bank shall be encased in concrete with at least three inches of concrete at the top and bottom and two inches on each side. A horizontal and vertical separation between the ducts of \* inches shall be maintained by installing Carlon high impact spacers with horizontal and vertical locking intervals of \*\*feet.

\*Standard separations of 1 in., 1½ in., 2 in. and 3 in. are available.

\*\*Preferred interval between spacer assemblies is 8 to 10 feet.

### Installation note

The spacers and rebar holder are designed with a dovetail tongue-and-groove feature for easy installation. If required to permanently fix the position of a group of spacers and/or rebar holder, the following are recommended procedures:

1. Use Carlon quick-set cement glue during assembly or spot glue after assembly to secure.
2. During assembly, deform the edge of the tongue or groove portion of the dovetail slide with a pair of pliers or similar tool. This deformation will create an interference, restricting movement.
3. An assembled system may be wired together for additional support.

### Important

1. The use of duct spacers for direct burial may result in excessive point deflections unless proper design engineering is applied, such as the proper compaction of the appropriate backfill material.
2. ABB is not responsible for Snap-Loc spacers used in direct burial application; design engineers and contractors are responsible for the design of the installation.

## Snap-N-Stac combo spacers

### Product overview



One-way

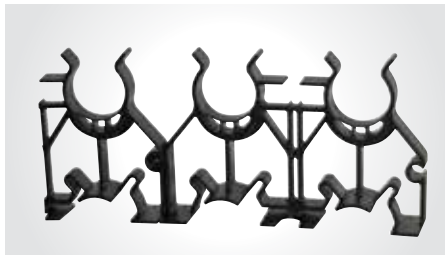

Three-way

### Installations



Horizontal locking



Vertical interlocking



With reducer

Carlson Snap-N-Stac combo duct spacers are specifically designed to replace the two-piece base and intermediate spacer system, by combining the conventional base and intermediate spacer into a single unit.

Manufactured out of highly engineered thermoplastic material, Snap-N-Stac spacers are strong, durable and able to withstand the rigors of concrete construction. They feature an innovative horizontal and exclusive vertical locking system and can be used as either a base or intermediate spacer.

Snap-N-Stac spacers are available in one-way, two-way and three-way configurations (one-way and three-way only available in sizes 2 in. and 4 in.). They accept 2 in., 3 in., 4 in., 5 in., and 6 in. pipe and can be installed horizontally, vertically or turned upright for unique duct bank configurations.

This one-piece design makes underground duct bank installations faster and easier than the conventional two-piece system – saving material and labor costs.

Carlson Snap-N-Stac combo spacers...The ideal solution for underground duct bank installations.

### Features

- Conventional base and intermediate spacer in a single unit
- Less inventory required
- Exclusive vertical locking system
- Horizontal locking system
- Installs horizontally or turned upright
- Molded-in rebar holder on two-way and three-way
- One-, two- and three-way configurations (one-way and three-way only available in sizes 2 in. and 4 in.)
- 5 sizes: 2 in., 3 in., 4 in., 5 in. and 6 in.
- Reducer to accommodate smaller duct sizes
- Can be used as either an intermediate or base spacer
- Spacers interlock horizontally regardless of size
- Nonmetallic, non-corrosive, non-conductive
- Strong and durable
- Easy to handle
- Fast installation

## Snap-N-Stack combo spacers

### Installation instructions

#### Important

1. Snap-N-Stack Spacers are recommended for concrete-encased applications only.
2. The use of duct spacers for direct burial may result in excessive point deflections unless proper design engineering is applied, such as the proper compaction of the appropriate backfill material.
3. ABB is NOT responsible for Snap-N-Stack spacers used in direct burial applications; design engineers and contractors are responsible for the design of the installation.

#### Vertical interlocking slide spacers together "feet facing feet."



Feet facing

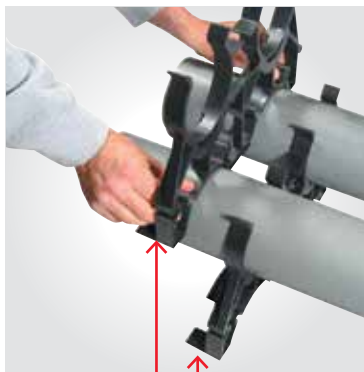

Feet opposite



#### Molded-in rebar holder

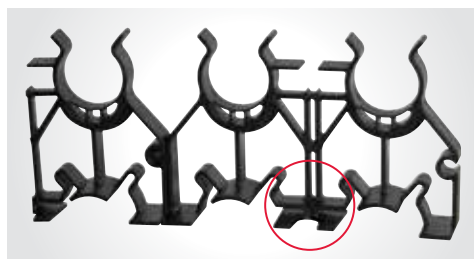
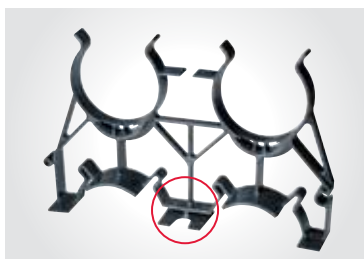

## Snap-N-Stac combo spacers

### Installation instructions

#### Vertical free-standing

If spacers are installed using free-standing method, it is recommended to install the spacer on the upper row mid-way between the two spacers on the bottom row.



#### Reducer

1 in. and 2 in. Snap-Loc reducers allow fixturing of 1 in. and 2 in. conduit inside of larger spacers.



#### Transition to various duct sizes

Install spacers side-by-side by inserting the male adapter into the female adapter.

Note: All Snap-N-Stac spacers are designed to interlock horizontally, regardless of size.



#### Odd number of ducts

Two-way spacers, size 2 in. and 4 in. only, can easily be cut apart to produce two one-way spacers. Create three-way and five-way spacers using the

one-way spacer. Install spacers side-by-side by inserting the male adapter into the female adapter.

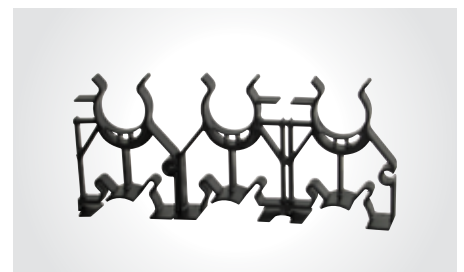

## Snap-N-Stack combo spacers

### Specifications

Cat. no.	Description	Size (in.)	Separation (in.)	Std. ctn. qty.	Std. ctn. wt. (lb)
SP2W20-1	1-Way spacers	2	2	56	15.0
SP2W30-1	1-Way spacers	2	3	40	13.0
SP4W15-1	1-Way spacers	4	1½	26	9.6
SP4W20-1	1-Way spacers	4	2	20	10.0
SP4W30-1	1-Way spacers	4	3	20	9.4
SP2W20-2	2-Way spacers	2	2	56	28.5
SP2W30-2	2-Way spacers	2	3	40	23.8
SP3W20-2	2-Way spacers	3	2	40	24.0
SP3W30-2	2-Way spacers	3	3	24	17.9
SP4W15-2*	2-Way spacers	4	1½	26	18.3
SP4W20-2*	2-Way spacers	4	2	24	18.8
SP4W30-2*	2-Way spacers	4	3	20	17.6
SP5W20-2*	2-Way spacers	5	2	20	17.2
SP5W30-2*	2-Way spacers	5	3	14	15.5
SP6W20-2*	2-Way spacers	6	2	12	12.8
SP6W30-2*	2-Way spacers	6	3	12	14.1
SP2W20-3	3-Way spacers	2	2	36	28.5
SP2W30-3	3-Way spacers	2	3	18	17.8
SP4W15-3	3-Way spacers	4	1½	18	19.4
SP4W20-3	3-Way spacers	4	2	16	19.3
SP4W30-3	3-Way spacers	4	3	14	19.1

\*Can be cut apart to make (2) one-way spacers

### Technical information

Cat. no.	Duct size (in.)	Duct O.D. (in.)	Horizontal duct positions	Duct-to-duct spacing		Center-to-center spacing		Bottom of trench to bottom of duct (in.)	Bottom of trench to center of bottom duct (in.)	Overall length (in.)
				Vertical (in.)	Horizontal (in.)	Vertical (in.)	Horizontal (in.)			
SP2W20-1	2	2.375	1	2	2	2.19	2.19	3.13	4.25	4.38
SP2W30-1	2	2.375	1	3	3	2.69	2.69	4.13	5.25	5.38
SP4W15-1	4	4.500	1	1.5	1.5	3.00	3.00	3.38	5.56	6.00
SP4W20-1	4	4.500	1	2	2	3.25	3.25	3.88	6.06	6.50
SP4W30-1	4	4.500	1	3	3	3.75	3.75	4.88	7.06	7.50
SP2W20-2	2	2.375	2	2	2	4.38	4.38	3.13	4.25	8.75
SP2W30-2	2	2.375	2	3	3	5.38	5.38	4.13	5.25	10.75
SP3W20-2	3	3.500	2	2	2	5.50	5.50	3.63	5.38	11.00
SP3W30-2	3	3.500	2	3	3	6.50	6.50	4.63	6.38	13.00
SP4W15-2	4	4.500	2	1.5	1.5	6.00	6.00	3.38	5.56	12.00
SP4W20-2	4	4.500	2	2	2	6.50	6.50	3.88	6.06	13.00
SP4W30-2	4	4.500	2	3	3	7.50	7.50	4.88	7.06	15.00
SP5W20-2	5	5.500	2	2	2	7.56	7.56	4.38	7.25	15.12
SP5W30-2	5	5.500	2	3	3	8.56	8.56	5.38	8.25	17.14
SP6W20-2	6	6.625	2	2	2	8.62	8.62	4.13	7.38	17.25
SP6W30-2	6	6.625	2	3	3	9.62	9.62	5.13	8.38	19.25
SP2W20-3	2	2.375	3	2	2	6.57	6.57	3.13	4.25	13.13
SP2W30-3	2	2.375	3	3	3	8.07	8.07	4.13	5.25	16.13
SP4W15-3	4	4.500	3	1.5	1.5	9.00	9.00	3.38	5.56	18.00
SP4W20-3	4	4.500	3	2	2	9.75	9.75	3.88	6.06	19.50
SP4W30-3	4	4.500	3	3	3	11.25	11.25	4.88	7.06	22.50

### How to interpret the catalogue number

Position 1	Position 2	Position 3	Position 4
		Duct-to-duct spacing	
		Horizontal and vertical	Horizontal duct positions
Product type	Duct size		
SP = Spacer	2W = 2 in. Width	15 = 1½ in.	-1 = One-way
	3W = 3 in. Width	20 = 2 in.	-2 = Two-way
	4W = 4 in. Width	30 = 3 in.	-3 = Three-way
	5W = 5 in. Width		
	6W = 6 in. Width		



## Carflex liquidtight flexible conduit

### Product overview



Liquidtight flexible nonmetallic conduit provides superior wire protection in harsh, damp environments. Carflex conduit is non-conductive, non-corrosive and resistant to oil, acid, ozone and alkaline. Carflex conduit is strong and lightweight, and because it weighs 50% less than metallic systems, it's easy to handle, transport and install. Carflex is ideal for industrial, air conditioning, heating and outdoor lighting applications.

#### Features

- Non-conductive and non-corrosive
- Lightweight for easy handling, transportation and installation
- Crush, abrasion and strain resistant
- Provides superior wire protection
- Smooth interior ideal for pulling cable
- No jagged edges
- Maintains internal I.D. even in tight radius bends
- Type LFNC-B
- Resistant to oil, acid, ozone and alkaline
- CSA certified as per Section 12-1300 of the Canadian Electrical Code, Part 1
- Sequentially marked footage
- Suitable for use at conduit temperatures of 80 °C dry, 60 °C wet and 60 °C oil

Note: Liquidtight flexible conduit, metallic and nonmetallic, in contrast to rigid PVC conduit and electrical nonmetallic tubing, do not have wire temperature limitations. Any temperature rated wire (for example, 90 °C wire) can be used as long as the temperature conditions marked on the conduit are not exceeded.

#### Applications

- Control and motor
- Air conditioning and heating
- Computer power distribution
- Machine tools
- Console wiring
- Transformer connections
- Outdoor lighting

#### Coils



Cat. no.	Nom. size (in.)	Avg. O.D. (in.)	Avg. I.D. (in.)	Length reel (ft.)	Std. reel wt. (lb)
15004-100	3/8	0.700	0.4890	100	11.70
15005C-025	1/2	0.830	0.6270	25	3.25
15005-100	1/2	0.830	0.6270	100	14.4
15007-100	3/4	1.040	0.8250	100	18.00
15007C-025	3/4	1.040	0.8250	25	4.25
15008-100	1	1.302	1.046	100	28.00
15009-100	1 1/4	1.645	1.385	100	37.60
15010-050	1 1/2	1.882	1.580	50	22.55
15010-100	1 1/2	1.882	1.580	100	47.80
15011-050	2	2.357	2.025	50	34.10

Standard colour Grey

#### Reels



Cat. no.	Nom. size (in.)	Avg. O.D. (in.)	Avg. I.D. (in.)	Length reel (ft.)	Std. reel wt. (lb)
15004-001	3/8	0.700	0.4890	1000	145.0
15005-001	1/2	0.830	0.6270	1000	157.0
15007-001	3/4	1.040	0.8250	1000	212.0
15008-500	1	1.302	1.046	500	155.0
15009-200	1 1/4	1.645	1.385	200	100.0
15010-150	1 1/2	1.882	1.580	150	95.7
15011-100	2	2.357	2.025	100	94.6

## Carflex X-Flex liquidtight flexible tubing

### Product overview



Extra flexible nonmetallic mechanical protection tubing is ideal for applications requiring extra strength and flexibility such as robotics and repetitive flexing arms. Carflex X-Flex is non-conductive, non-corrosive and resistant to oil, acid, ozone and alkaline. It's designed for use with standard Carflex fittings providing a complete nonmetallic system. Carflex X-Flex is lightweight for easier handling, transportation and installation.

#### Features

- Extra strong and flexible to withstand repetitive motions
- Non-conductive and non-corrosive
- Resistant to oil, acid, ozone and alkaline
- Lightweight for easy handling, transportation and installation
- Crush, abrasion and strain resistant
- Provides superior wire protection
- Smooth interior ideal for pulling cable
- No jagged edges
- Rated for continuous use at 60 °C ambient
- Type NMPT-B

#### Applications

- Repetitive flexing arms
- Robotics
- Machine tools
- Automatic/moving machinery
- Control and motor

### Specifications

Coils (available in black only)



Cat. no.	Nom. size (in.)	Avg. O.D. (in.)	Avg. I.D. (in.)	Length coils (ft.)	Std. coil wt. (lb)
15104-100 ◆	3/8	0.700	0.489	100	9.09
15105-100 ◆	1/2	0.830	0.627	100	10.01
15107-100 ◆	3/4	1.040	0.825	100	13.91
15108-100	1	1.302	1.046	100	18.25
15109-100	1 1/4	1.645	1.385	100	27.65
15110-100	1 1/2	1.882	1.580	100	38.00
15111-050	2	2.357	2.025	50	24.22

# Carflex liquidtight fittings

## Straight fittings

For use with Carflex conduit and Carflex X-Flex conduit

Image 1



Assembly

Image 2

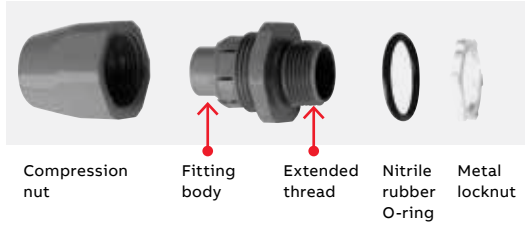

Compression nut

Fitting body

Extended thread

Nitrile rubber O-ring

Metal locknut

Image 3



Assembly

Image 4



Compression nut

Sealing ring

Ferrule

Fitting body

O-ring

Plastic locknut

### Features

- Non-conductive and non-corrosive
- Easy to install
- Resistant to oil, acid, ozone and alkaline
- Approved for indoor and outdoor locations
- Listed for “wet locations”
- Nitrile rubber O-ring for a liquidtight termination
- Temperatures up to 107 °C

### Specifications



Cat. no.	Size (in.)	Std. ctn. qty.	Std. ctn. wt. (lb)	Dimensions (in.)						Refer to Image
				A	B	C	D	E		
LT43C	3/8	50	3.6	0.55	0.75	1.60	1.30	1.40	1-2	
LT43D-NEW	1/2	50	4.2	0.56	0.91	1.62	1.30	1.40	1-2	
LT43E-NEW	3/4	50	6.6	0.56	0.91	1.88	1.61	1.71	1-2	
LT43F-NEW	1	25	5.5	0.70	1.00	2.20	1.90	2.04	1-2	
LT43G	1 1/4	5	1.5	0.71	1.16	2.50	2.17	-	3-4	
LT43H	1 1/2	5	2.0	0.75	1.36	2.78	2.43	-	3-4	
LT43J	2	5	2.5	1.00	1.45	3.33	-	-	3-4	

### Diagrams

Typ. dimension with Carflex installed

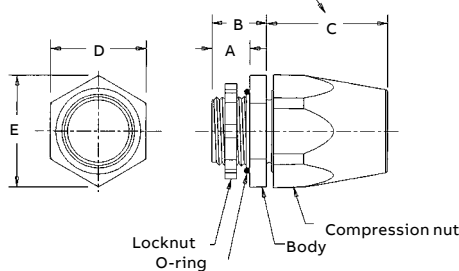

LT43C-CAR, LT43D-NEW, LT43E-NEW, LT43F

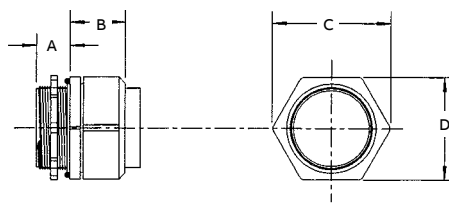

LT43G, LT43H

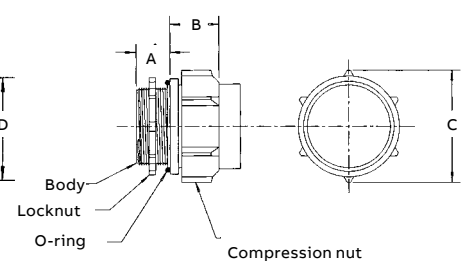

LT43J

# Carflex liquidtight fittings

## 90° Fittings

### For use with Carflex conduit and Carflex X-Flex conduit

Image 1



Assembly

Image 2

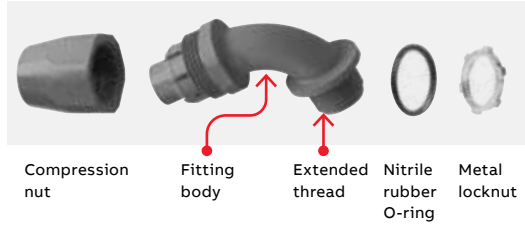

Compression nut

Fitting body

Extended thread

Nitrile rubber O-ring

Metal locknut

Image 3



Assembly

Image 4



Compression nut

Sealing ring

Ferrule

Fitting body

O-ring

Plastic locknut

### Features

- Non-conductive and non-corrosive
- Easy to install
- Resistant to oil, acid, ozone and alkaline
- Approved for indoor and outdoor locations
- Listed for “wet locations”
- Nitrile rubber O-ring for a liquidtight termination
- Temperatures up to 107 °C

### Specifications



Cat. no.	Size (in.)	Std. ctn. qty.	Std. ctn. wt. (lb)	Dimensions (in.)								Refer to Image
				A	B	C	D	E	F	G		
LT20C	3/8	50	3.6	0.56	1.44	1.44	1.56	1.39	1.26	-	1-2	
LT20D-NEW	1/2	50	4.2	0.56	1.76	2.05	1.62	1.40	1.30	1.15	1-2	
LT20E-NEW	3/4	50	6.6	0.56	2.04	2.35	1.88	1.71	1.61	1.50	1-2	
LT20F-NEW	1	25	5.5	0.70	2.01	2.01	2.26	2.04	1.90	-	1-2	
LT20G	1 1/4	5	1.5	0.75	2.50	3.55	2.48	-	-	-	3-4	
LT20H	1 1/2	5	2.0	0.75	2.80	3.98	2.77	-	-	-	3-4	
LT20J	2	5	2.5	0.94	3.48	4.56	3.33	-	-	-	3-4	

### Diagrams

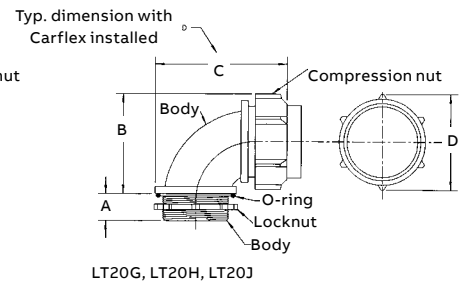
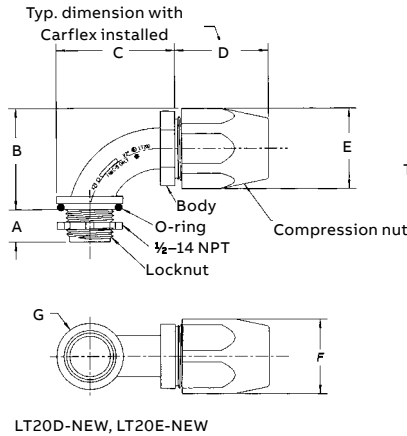
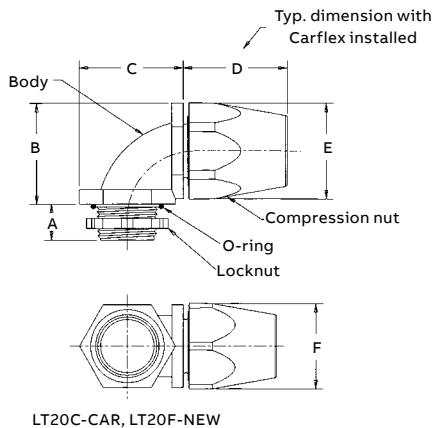

## Carflex one-piece liquidtight fittings

### Product overview



#### Unique design

The simple, one-piece body design of the Carflex one-piece liquidtight nonmetallic fitting requires no disassembly of components for installation. The system is so strong that there is no need for a compression nut.

#### PVC construction

PVC construction of the fitting and locknut provides unparalleled protection from water, oil and dust. Totally nonmetallic, the system is non-conductive and will not corrode or rust. Temperatures up to 60 °C

#### Features

- Approved for indoor and outdoor locations
- Listed for “wet locations”

### Straight fittings



Cat. no.	Trade size (in.)	Std. ctn. qty.	Std. ctn. wt. (lb)	Thread size (NPT)	Dimensions (in.)		
					A	D	E
LN43DA	½	100	2.8	14	0.56	1.34	1.19
LN43EA	¾	50	2.2	14	0.56	1.63	1.44
LN43FA	1	25	3	11-½	0.69	1.99	1.75



#### Diagrams

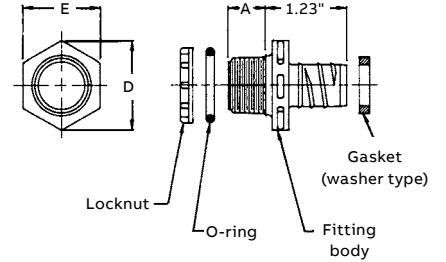

### 90° Fittings



Cat. no.	Trade size (in.)	Std. ctn. qty.	Std. ctn. wt. (lb)	Thread size (NPT)	Dimensions (in.)				
					A	B	C	D	E
LN20DA	½	100	4.3	14	0.56	1.50	1.99	1.34	1.19
LN20EA	¾	50	3.1	14	0.56	1.73	2.25	1.63	1.44
LN20FA	1	25	3.2	11-½	0.69	1.86	2.58	1.99	1.75



#### Diagrams

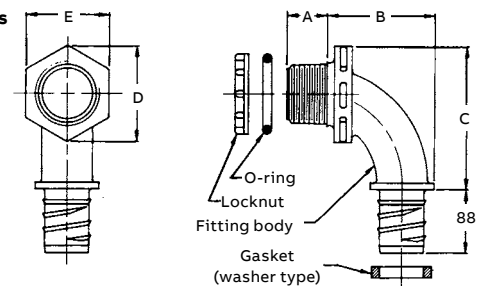

## Carflex one-piece liquidtight fittings

### Installation instructions

#### LT43C-CAR, LT43F thru J, LT20C-CAR, LT20F thru J

1. Cut the end of the Carflex conduit or Carflex X-Flex tubing square.
2. Install compression nut and sealing gland ring over the end of the conduit or tubing.
3. Insert the ferrule end of the fitting into the conduit using a clockwise twisting action.
4. Screw fitting body into compression nut.
5. When installation is completed, use a wrench, tighten compression nut one-quarter ( $\frac{1}{4}$ ) turn past hand-tight. Do not over tighten fitting.

To prevent damage to conductors, conduit and fittings, do not twist Carflex during installation.

1. There shall be no more than the equivalent of four (4) quarter (90°) bends (360° total) between pull points, conduit bodies and boxes.
2. The radius of the curve of the center of the conduit or tubing shall not be less than that shown in the table below:

#### LT43D-NEW, LT43E-NEW, LT20D-NEW, LT20E-NEW

1. Cut the end of the Carflex conduit or Carflex X-Flex tubing square.
2. Install compression nut over the end of the conduit or tubing.
3. Insert the ferrule end of the fitting into the conduit using a clockwise twisting action. (Be sure conduit is fully inserted to the bottom of the fitting shoulder).
4. Screw compression nut onto fitting body.
5. Use a wrench, and tighten compression nut one (1) full turn past hand-tight. Do not over tighten fitting.

To prevent damage to conductors, conduit and fittings, do not twist Carflex during installation.

### Liquidtight conduit technical information

Size of conduit or tubing		Radius to center of conduit or tubing	
Inches	mm	Inches	mm
$\frac{3}{8}$	14	4	101.6
$\frac{1}{2}$	16	4	101.6
$\frac{3}{4}$	21	4 $\frac{1}{2}$	114.3
1	27	5 $\frac{3}{4}$	146.0
1 $\frac{1}{4}$	35	7 $\frac{1}{4}$	184.1
1 $\frac{1}{2}$	41	8 $\frac{1}{4}$	209.5
2	53	9 $\frac{1}{2}$	241.3

## Plenum-Gard

### Product overview



#### Technical information

UL Standard 2024	Value
Maximum flame propagation	5 ft.
Max. peak optical smoke density	0.5
Max. average optical smoke density	0.15

#### Standard stock – Reels

Cat. no.	Size (in.)	Colour	Pull tape	Reel size (F x W) (in.)	Reel type	Length (ft.)	Reel wt. (lb)	Product wt. per 100 ft. (lb)
CD4X1C-1500	½	Orange	200 lb	34 x 23	Wood	1,500	30	7
CE4X1-1000	¾	Orange	Empty	34 x 23	Wood	1,000	30	8
CE4X1-1000S	¾	Orange	Empty	34 x 23	Wood	1,000	30	8
CF4X1C-500	1	Orange	900 lb	34 x 23	Wood	500	30	10
CF4X1C-1000	1	Orange	900 lb	48 x 28	Wood	1,000	79	10
CF4X1C-1500	1	Orange	900 lb	48 x 28	Wood	1,500	79	10
CF4X1C-5200	1	Orange	900 lb	66 x 41	Wood	5,200	250	10
CF4X1C-6500	1	Orange	900 lb	72 x 41	Wood	6,500	310	10
CF4X1C-8000	1	Orange	900 lb	82 x 41	Wood	8,000	365	10
CG4X1C-500	1¼	Orange	900 lb	48 x 28	Wood	500	79	14
CG4X1C-900	1¼	Orange	900 lb	48 x 45	Wood	900	96	14
CG4X1C-1600	1¼	Orange	900 lb	48 x 45	Wood	1,600	96	14
CG4X1C-3200	1¼	Orange	900 lb	66 x 41	Wood	3,200	250	14
CG4X1C-6500	1¼	Orange	900 lb	96 x 41	Wood	6,500	700	14
CG4X1C-900S	1¼	Orange	Empty	48 x 28	Wood	900	79	14
CH4X1C-350	1½	Orange	900 lb	48 x 28	Wood	350	79	16
CH4X1C-1200	1½	Orange	900 lb	48 x 45	Wood	1,200	96	16
CH4X1C-4000	1½	Orange	900 lb	82 x 41	Wood	4,000	365	16
CJ4X1C-225	2	Orange	900 lb	48 x 28	Wood	225	79	21
CJ4X1C-700	2	Orange	900 lb	48 x 45	Wood	700	96	21
CJ4X1C-2000	2	Orange	900 lb	82 x 41	Wood	2,000	365	21
CJ4X1C-2800	2	Orange	900 lb	82 x 41	Wood	2,800	365	21
CL4X1C-150	3	Orange	900 lb	48 x 45	Wood	150	96	41

Plenum-Gard is a nonmetallic corrugated flexible conduit for use in plenum, riser and general purpose applications.

Plenum-Gard is manufactured from PVDF resin, which is extremely durable and resistant to abrasion and mechanical damage before/after installation.

Plenum-Gard is listed for plenum, riser, general purpose and other cabling optical fiber/telecommunication applications.

#### Applications:

Plenum, riser and general purpose.

#### Important:

Installed cables must be plenum rated.

- Storage: -20 °C to 70 °C (-4 °F to 158 °F)
- Handling: -20 °C to 40 °C (-4 °F to 104 °F)
- No UV protection (not suitable for outdoor use)
- Do NOT store outside



## Plenum-Gard

### Features

- Sizes ½ in. through 3 in.
- Pre-installed pull tape available in sizes ½ in. through 3 in.
- Outside diameters meet IPS dimensions
- Footage sequentially marked

### Standard stock – Coils

Cat. no.	Size (in.)	Colour	Pull tape	Coil length (ft.)	Product wt. per 100 ft. (lb)
CD4X1C-500	½	Orange	900 lb	500	7
CE4X1-350	¾	Orange	Empty	350	8
CE4X1-350S	¾	Orange	Empty/split	350	8
CF4X1C-100	1	Orange	900 lb	100	10
CF4X1-100S	1	Orange	Empty/split	100	10
CF4X1C-250	1	Orange	900 lb	250	10
CF4X1-250	1	Orange	Empty	250	10
CF4X1-250S	1	Orange	Empty/split	250	10
CG4X1C-200	1¼	Orange	900 lb	200	14
CG4X1-200S	1¼	Orange	Empty/split	200	14
CH4X1C-150	1½	Orange	900 lb	150	16
CH4X1-150S	1½	Orange	Empty/split	150	16
CJ4X1C-100	2	Orange	900 lb	100	21
CJ4X1-100S	2	Orange	Empty/split	100	21
CL4X1C-150	3	Orange	920 lb	150	24

### Specifications

Size (in.)	I.D. min. ref. (in.)	Min. O.D. (in.)	Max. O.D. (in.)	Min. bend radius (in.)
½	0.60	0.815	0.835	2
¾	0.74	1.025	1.045	2
1	1.00	1.292	1.312	3
1¼	1.35	1.630	1.650	3
1½	1.50	1.868	1.888	4
2	2.00	2.329	2.439	4
3	3.00	3.422	3.452	4

### How to build a catalogue number:

Position 1 product	Position 2 size (in.)	Position 3 type	Position 4 wall	Position 5 colour	Position 6 pull line	Position 7 length
C = Plenum-Gard	D = ½ E = ¾ F = 1 G = 1¼ H = 1½ J = 2 L = 3	4 = Corrugated	X = Standard	1 = Orange 2 = Black 3 = Grey 4 = White 5 = Blue 7 = Yellow 8 = Red	C = 900 lb Tape	Example -1000 = Feet -1000S = 1000 feet split

- Custom orders are not returnable
- Custom lengths are available in minimum order quantities of 1,000 ft.
- Custom colour runs are available in minimum order quantities of 10,000 ft.

### Options:

- Colour: Black, blue, grey, red, white and yellow
- Two, three or four way parallel
- Split duct
- Custom print line



# Riser-Gard

## Product overview



Riser-Gard is a nonmetallic flexible raceway for use in riser and general purpose applications. Riser-Gard is available with tape pre-installed.

Riser-Gard is listed for riser, general purpose and other cabling optical fiber/telecommunication applications. Riser-Gard is suitable for use in vertical runs in shaft or between floors, as well as areas other than the plenum.

**Applications:**

Riser and general purpose.

**Important:**

Installed cables must be of suitable rating for the application.

- For use in riser and general purpose areas
- Riser-Gard is also suitable for poured concrete
- Not approved for exposed applications
- Available in sizes ¾ in. through 3 in.
- Pull tape can be factory pre-installed in 1 in. through 3 in.
- Outside diameters meet IPS dimensions
- Footage sequentially marked

**Technical information**

UL Standard 2024	Max. value
Maximum flame propagation	6.0 ft.
Maximum air temperature at 12 ft.	189 °C (372 °F)

- Storage: -20 °C to 70 °C (-4 °F to 158 °F)
- Handling: -20 °C to 40 °C (-4 °F to 104 °F)
- No UV protection (not suitable for outdoor use)
- Do not store outside

**Standard stock – Reels**



Cat. no.	Size (in.)	Colour	Pull tape	Reel size (F x W) (in.)	Reel type	Length (ft.)	Reel wt. (lb)	Product wt. per 100 ft. (lb)
DE4X1-1000	¾	Orange	Empty	34 x 23	Wood	1,000	30	12
DF4X1C-500R	1	Orange	900 lb	43 x 23	Wood	500	56	15
DF4X1C-1000	1	Orange	900 lb	48 x 28	Wood	1,000	79	15
DF4X1C-1500	1	Orange	900 lb	48 x 28	Wood	1,500	79	15
DF4X1C-2700	1	Orange	900 lb	48 x 45	Wood	2,700	96	15
DF4X1C-5200	1	Orange	900 lb	66 x 41	Wood	5,200	250	15
DF4X1C-6500	1	Orange	900 lb	72 x 41	Wood	6,500	310	15
DF4X1C-7000	1	Orange	900 lb	72 x 45	Steel	7,000	148	15
DF4X1C-9400	1	Orange	900 lb	84 x 45	Steel	9,400	199	15
DG4X1C-900	1¼	Orange	900 lb	48 x 28	Wood	900	79	17
DG4X1C-500R	1¼	Orange	900 lb	48 x 23	Wood	500	56	17
DG4X1C-1500	1¼	Orange	900 lb	48 x 45	Wood	1,500	96	17
DG4X1C-1600	1¼	Orange	900 lb	48 x 45	Wood	1,600	96	17
DG4X1C-3200	1¼	Orange	900 lb	66 x 41	Wood	3,200	250	17
DG4X1C-4500	1¼	Orange	900 lb	72 x 45	Steel	4,500	148	17
DG4X1C-5600	1¼	Orange	900 lb	82 x 41	Wood	5,600	365	17
DG4X1C-6500	1¼	Orange	900 lb	96 x 41	Steel	6,500	700	17
DH4X1C-1200	1½	Orange	900 lb	48 x 45	Wood	1,200	96	22
DH4X1C-4000	1½	Orange	900 lb	82 x 45	Steel	4,000	193	22
DH4X1C-4500	1½	Orange	900 lb	84 x 45	Steel	4,500	199	22
DJ4X1C-700	2	Orange	900 lb	48 x 45	Wood	700	96	27
DJ4X1C-2000	2	Orange	900 lb	82 x 41	Wood	2,000	265	27
DJ4X1C-2800	2	Orange	900 lb	84 x 45	Steel	2,800	199	27
DL4X1C-750	3	Orange	900 lb	72 x 41	Wood	750	310	27

## Riser-Gard

### Features

- Riser-Gard is also suitable for direct burial. Not approved for exposed applications.
- Available in sizes  $\frac{3}{4}$  in. through 3 in.
- Pull tape can be factory pre-installed

in 1 in. through 3 in.

- Outside diameters meet IPS dimensions.
- Footage sequentially marked.

### Standard stock – Coils

Cat. no.	Size (in.)	Colour	Pull tape	Coil length (ft.)	Product wt. per 100 ft. (lb)
DE4X1-350	$\frac{3}{4}$	Orange	Empty	350	12
DF4X1C-125	1	Orange	900 lb	125	15
DF4X1C-250	1	Orange	900 lb	250	15
DF4X1-250	1	Orange	Empty	250	15
DF4X1C-500	1	Orange	900 lb	500	15
DF4X1-250S	1	Orange	Empty/split	250	15
DG4X1-200	$1\frac{1}{4}$	Orange	Empty	200	17
DG4X1-200S	$1\frac{1}{4}$	Orange	Empty/split	200	17
DG4X1C-200	$1\frac{1}{4}$	Orange	900 lb	200	17
DG4X1C-500	$1\frac{1}{4}$	Orange	900 lb	500	17
DH4X1-150S	$1\frac{1}{2}$	Orange	Empty/split	150	22
DH4X1C-150	$1\frac{1}{2}$	Orange	900 lb	150	22
DJ4X1-100S	2	Orange	Empty/split	100	27
DJ4X1C-100	2	Orange	900 lb	100	27
DL4X1C-250	3	Orange	900 lb	250	27

### Specifications

Size (in.)	I.D. min. ref. (in.)	Min. O.D. (in.)	Max. O.D. (in.)	Min. bend radius (in.)
$\frac{3}{4}$	0.74	1.025	1.075	5
1	0.98	1.290	1.340	6
$1\frac{1}{4}$	1.31	1.640	1.690	8
$1\frac{1}{2}$	1.54	1.880	1.930	10
2	2.00	2.350	2.400	12
3	3.00	3.422	3.452	18

### Custom orders

#### How to build a catalogue number:

Position 1 product	Position 2 size (in.)	Position 3 configuration	Position 4 wall	Position 5 colour	Position 6 pull line	Position 7 length
D = Riser-Gard	E = $\frac{3}{4}$ F = 1 G = $1\frac{1}{4}$ H = $1\frac{1}{2}$ J = 2 L = 3	4 = Corrugated	X = Standard	1 = Orange 2 = Black 3 = Grey 4 = White 5 = Blue 7 = Yellow 8 = Red	C = 900 lb Tape	Example -1000 = Feet -1000S = 1,000 feet split

- Custom Orders are not returnable
- Custom lengths are available in minimum order quantities of 1,000 ft.
- Custom colour runs are available in minimum order quantities of 10,000 ft.

#### Options:

- Colour: Black, blue, grey, red, white and yellow
- Two, three or four way parallel
- Split duct
- Custom print line

## Riser-Gard

Flexible raceway accessories (approved for low voltage use only)



### Low voltage add-on bracket

	Cat. no.	Description	Std. ctn. qty.	Std. ctn. wt. (lb)
	SC100SC	1 gang	24	2.3

### Low voltage adjustable brackets

	Cat. no.	Size	Std. ctn. qty.	Std. ctn. wt. (lb)
	SC100ADJC	1 gang	24	7.5
	SC200ADJC	2 gang	20	6.9

### Low voltage brackets

	Cat. no.	Description	Resi-Rings (in.)	Std. ctn. qty.	Std. ctn. wt. (lb)
	SC100A	1 gang	¾, 1, 1¼	24	5.3
	SC200A	2 gang	¾, 1, 1¼	24	7.7
	SC300A	3 gang	-	5	1.6





### Conduit clamps

	Cat. no.	Size (in.)	Std. order qty.	Std. ctn. qty.	Std. ctn. wt. (lb)
	SCE977EC	¾	1 ea. (Equals one bag of 5 clamps)	20 bags of 5	1.5
	SCE977FC	1		12 bags of 5	1.3
	SCE977GC	1¼		8 bags of 5	1.1
	SCE977HC	1½		6 bags of 5	1.0
	SCE977JC	2		6 bags of 5	1.5

Note: Each clamp requires 2 screws, 2 nuts and/or 2 bolts.

Carlson's orange conduit clamps are designed specifically for the installation of Resi-Gard.

### Cable clips

	Cat. no.	Size (in.)	Std. order qty.	Std. ctn. qty.	Std. ctn. wt. (lb)
	SC14CC	¾	1 ea. (equals one bag of 100 clips)	10 bags of 100	2.23
	SC12CC	½	1 ea. (equals one bag of 25 clips)	10 bags of 25	2.31
	SC34CC	¾	1 ea. (equals one bag of 10 clips)	20 bags of 10	2.96

Carlson's cable clips with pre-installed nails provide fast and easy installation for either a single cable, 2-3 cables or 1 bundled cable.

## Hal-Free Riser-Gard

### Product overview



Hal-Free Riser-Gard is a halogen-free nonmetallic flexible raceway for use in riser and general purpose applications. In the event of a fire, this product will not release halogen elements into the air, which makes it ideal for applications in tunnels, laboratories and high-tech environments.

Custom lengths and split ducts are available upon request.

Hal-free Riser-Gard is available in white only.

- Storage and handling: -20 °C to 66 °C (-4 °F to 150 °F)
- No UV protection (not suitable for outdoor use)
- Do not store outside
- Free from halogen elements
- Available in sizes 1 in. through 2 in.
- Available in white only
- Sequentially marked footage

#### Applications:

Riser and general purpose

#### Technical information:

UL Standard 2024	Max. value
Maximum flame propagation	3 ft. 6 in.
Maximum air temperature	197 °C (387 °F)

#### Standard stock – Reels



Cat. no.	Size (in.)	Colour	Nom. I.D. (in.)	Nom. O.D. (in.)	Pull tape	Reel size (F x W) (in.)	Reel type	Reel length (ft.)	Reel wt. (lb)	Product wt. per 100 ft. (lb)
HF4X4C-5000	1	White	1.049	1.365	900 lb	72 x 41	Wood	5,000	310	7.5
HG4X4C-4000	1¼	White	1.250	1.550	900 lb	72 x 41	Wood	4,000	310	7.5
HH4X4C-2000	1½	White	1.500	1.850	900 lb	66 x 41	Wood	2,000	250	12
HJ4X4C-2000	2	White	2.000	2.425	900 lb	82 x 41	Wood	2,000	365	21

## Resi-Gard

### Nonmetallic adapters and couplings

#### For use with Riser-Gard and general purpose

##### Couplings

	Cat. no.	Size (in.)	Colour	Std. ctn. qty.	Std. ctn. wt. (lb)
	SCA240E	¾	Orange	25	0.783
	SCA240F	1	Orange	20	0.972

##### Threaded adapters

	Cat. no.	Size (in.)	Colour	Std. ctn. qty.	Std. ctn. wt. (lb)
	SCA243E	¾	Orange	100	2.30
	SCA243F	1	Orange	50	2.00

##### Snap-in adapters

	Cat. no.	Size (in.)	Colour	Std. ctn. qty.	Std. ctn. wt. (lb)
	SCA253E	¾	Orange	100	2.90
	SCA253F	1	Orange	50	2.30

#### For use with Plenum-Gard

##### Coupling

	Cat. no.	Size (in.)	Colour	Std. ctn. qty.	Std. ctn. wt. (lb)
	A340F	1	Orange	50	2.50

##### Threaded adapter

	Cat. no.	Size (in.)	Colour	Std. ctn. qty.	Std. ctn. wt. (lb)
	A343F	1	Orange	50	1.55

##### Snap-in adapter

	Cat. no.	Size (in.)	Colour	Std. ctn. qty.	Std. ctn. wt. (lb)
	A353F	1	Orange	50	3.00

## Resi-Gard

Flexible raceway (approved for low voltage use only)



### Standard length reels

Cat. no.	Size (in.)	Pull tape length (ft.)	Reel length (ft.)	Prod. wt. (lb)
SCE4X1-1000	¾	Empty	1,000	115.0
SCF4X1C-1500	1	900 lb	1,500	268.5
SCJ4X1C-500	2	900 lb	500	133.5

### Resi-Gard fittings

A complete line of Carlon one-piece quick connect couplings, threaded adapters and snap-in terminator adapters are available for quick, easy professional installation of Resi-Gard flexible raceway.

### Quick connect couplings

	Cat. no.	Size (in.)	Std. ctn. qty.	Std. ctn. wt. (lb)
	SCA240E	¾	25	0.783
	SCA240F	1	20	0.972

### Quick connect threaded adapters

	Cat. no.	Size (in.)	Std. ctn. qty.	Std. ctn. wt. (lb)
	SCA243E	¾	25	0.633
	SCA243F	1	20	0.778

Ideal for providing a main chase from the main distribution panel to a secondary hub in the attic or basement. Resi-Gard nonmetallic flexible raceway is available in ¾ in. to 2 in. diameter sizes with factory installed pull tape in sizes 1 in. to 2 in. The raceway is hand bendable, lightweight and easily cut to length to reduce scrap. Bright orange colour clearly signifies a low voltage installation.

### Standard length coils

Cat. no.	Size (in.)	Pull tape length (ft.)	Coil length (ft.)	Prod. wt. (lb)
SCE4X1-100	¾	Empty	100	11.5
SCF4X1C-100	1	900 lb	100	17.9
SCG4X1C-100	1¼	900 lb	100	21.5
SCH4X1C-50	1½	900 lb	50	11.2
SCJ4X1C-50	2	900 lb	50	13.4

### Quick connect snap-in adapters

	Cat. no.	Size (in.)	Std. ctn. qty.	Std. ctn. wt. (lb)
	SCA253E	¾	25	0.783
	SCA253F	1	20	0.918

### Male terminal adapters\*

	Cat. no.	Size (in.)	Std. ctn. qty.	Std. ctn. wt. (lb)
	SCE943G	1¼	50	3.0
	SCE943H	1½	25	2.5
	SCE943J	2	50	6.8

### Standard couplings\*

	Cat. no.	Size (in.)	Std. ctn. qty.	Std. ctn. wt. (lb)
	SCE940G	1¼	30	3.5
	SCE940H	1½	25	3.9
	SCE940J	2	30	5.2

\*Must be cemented to Resi-Gard flexible raceway using only Resi-Gard solvent cement.

## Micro-Gard

### Plenum and riser

Carlton Micro-Gard plenum and Micro-Gard riser are specifically designed to provide fiber pathways in plenum and riser applications in multi-dwelling units (MDUs) and other premise structures.

The 8/6 and 12/10 mm size conduit can be installed individually or used to optimize space in existing duct structures. And the small size significantly reduces the structural damage caused during pass-throughs.

Micro-Gard plenum and riser are listed for plenum and riser applications. They're easy to handle, easy to install and easy to conceal, thus making them the ideal MDU cable management system.

Carlton Micro-Gard plenum and Micro-Gard riser. Small. Slick. Speedy. Ideal for telecom installs.

#### Features

- cUL listed for plenum and riser applications
- Two sizes: 8/6 mm and 12/10 mm – the smaller sizes accommodate the size constraints of multi-dwelling units and make installations faster and easier
- Smooth interior wall eliminates snag points and provides low coefficient of friction regardless of whether jetting or pull-tape is used
- Superior burn-through resistance for longer cable pulls
- Pre-installed pull-tape makes installing cable faster and easier (option available for empty duct)
- Sequentially marked footage to easily identify lengths and reduce waste
- Reel sizes from 1,000 to 5,000 feet for easy handling on the jobsite
- Future-proofing raceway system for fast, easy wire/cable upgrades, changes and moves
- Used in cable bundles

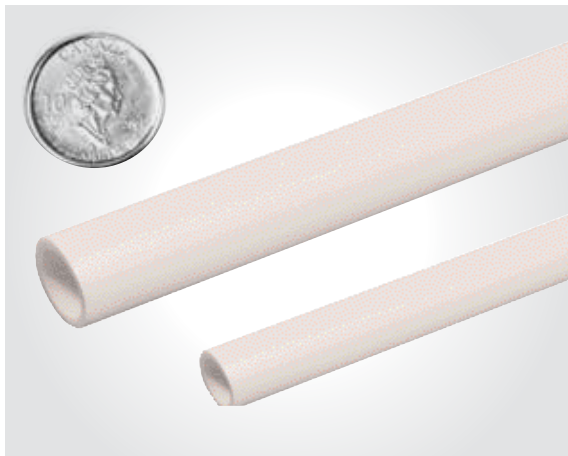

Micro-Gard plenum

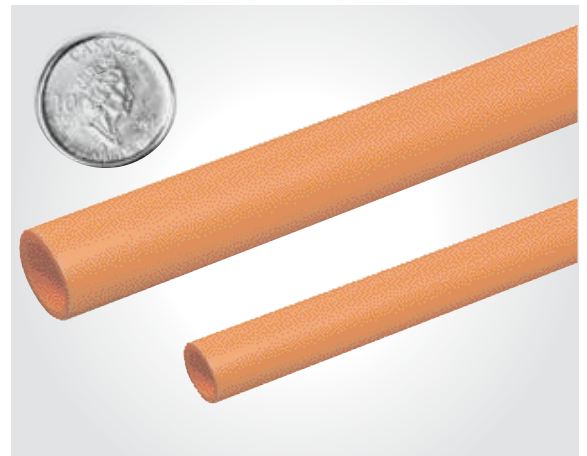

Micro-Gard riser

## Micro-Gard

### Plenum and riser



Cat. no.	Size (mm)	Type	Colour	Pre-installed tape	Min. bend radius (in.)*	Reel length (ft.)	Reel wt. (lb)
MGP08MT-1000	8/6	Plenum	White	200 lb	2	1,000	24
MGP08MT-2500	8/6	Plenum	White	200 lb	2	2,500	24
MGP08MT-5000	8/6	Plenum	White	200 lb	2	5,000	36
MGP12MT-1000	12/10	Plenum	White	200 lb	4	1,000	24
MGP12MT-2500	12/10	Plenum	White	200 lb	4	2,500	24
MGR08JT-1000	8/6	Riser	Orange	200 lb	2	1,000	24
MGR08JT-2500	8/6	Riser	Orange	200 lb	2	2,500	24
MGR08JT-5000	8/6	Riser	Orange	200 lb	2	5,000	36
MGR12JT-1000	12/10	Riser	Orange	200 lb	4	1,000	24
MGR12JT-2500	12/10	Riser	Orange	200 lb	4	2,500	24
MGR12JT-5000	12/10	Riser	Orange	200 lb	4	5,000	36

\* Important: Do not exceed the minimum bend radius during installation of the product.

#### How to interpret a catalogue number

Position 1 product	Position 2 type	Position 3 size	Position 4 colour	Position 5 pull line	Position 6 length
MG = Micro-Gard	P = Plenum R = Riser	08 = 8/6 mm 12 = 12/10 mm	J = Orange M = White	T = 200 lb tape	Example-1000 = 1,000 feet



## Flex-Plus Blue ENT



Flex-Plus Blue ENT is a nonmetallic flexible raceway for use in walls, floors and non-plenum ceilings. It's lightweight, hand bendable and free from sharp edges, which reduces installation time and saves money.

- Ideal storage conditions down to -20 °C (See page G73 for technical information.)

### Options

- Sizes ½ in. through 2 in.
- Colours can designate different voltages
- Yellow colour for communication circuits and signaling cable
- Red colour for fire alarm circuits
- Blue colour for power circuits

### Standard stock – Reels



Cat. no.	Size (in.)	Colour	Nom. I.D. (in.)	Nom. O.D. (in.)	Pull tape	Reel size	Reel type (W=Wood)	Reel length (ft.)	Reel wt. (lb)	Wt. per 100 ft. (lb)
1205AKC-001	½	Blue	0.56	0.84	Empty	36 x 24	W	1,500	40	10
1207AAC-001	¾	Blue	0.76	1.05	Empty	36 x 24	W	1,000	40	14
12008C-750	1	Blue	1.00	1.315	Empty	36 x 24	W	750	40	20
12009C-750	1¼	Blue	1.402	1.66	Empty	48 x 32	W	750	90	19
12009C-500	1¼	Blue	1.402	1.66	Empty	48 x 32	W	500	90	19
12010C-750	1½	Blue	1.554	1.90	Empty	48 x 32	W	750	90	39
12011C-500	2	Blue	2.030	2.375	Empty	48 x 32	W	500	90	32
12011C-225	2	Blue	2.030	2.375	Empty	48 x 32	W	225	90	32

1¼ in. – 2 in. available in yellow and red, made to order; contact your regional sales office.

### Standard stock – Coils

Cat. no.	Size (in.)	Colour	Nom. I.D. (in.)	Nom. O.D. (in.)	Pull Tape	Min. bend radius	Coil length (ft.)	Wt. per 100 ft. (lb)
12005C-200	½	Blue	0.56	0.84	Empty	6	200	10
12005C-370	½	Blue	0.56	0.84	Empty	6	370	10
12007C-100	¾	Blue	0.76	1.05	Empty	6	100	14
12007C-240	¾	Blue	0.76	1.05	Empty	6	240	14
12008C-160	1	Blue	1.00	1.315	Empty	6	160	22
12009C-500C	1¼	Blue	1.402	1.66	Empty	7	500	19
12010C-300C	1½	Blue	1.554	1.90	Empty	8¼	300	39
12011C-225C	2	Blue	2.030	2.375	Empty	9½	225	32

NOTE: The solid blue colour of ENT conduit is a registered trademark of Carlon.

ENT may show colour deterioration in direct sunlight when stored outdoors over an extended period of time. It is suggested that all ENT products not be stored outside.

## ENT stub-downs

### Vertical stub-down

Carlton vertical stub-downs are designed to provide a quick, easy connection to a wood deck or transition from slab-to-slab using Carlton's "quick connect" snap-in design... simply snap the ENT in place. The integral snaps provide a secure mount – preventing the ENT from pulling out while maintaining the ability for easy removal of the fitting once the deck is removed. All in a concrete-tight application. The underside of this fitting provides ample room to attach a Carlton coupling to the ENT to continue the run. Carlton vertical stub-downs are manufactured out of a highly engineered thermoplastic material to provide extra strength and durability and are available in sizes ½ in., ¾ in. and 1 in.

	Cat. no.	Size (in.)	Std. ctn. qty.	Std. ctn. wt. (lb)
	A210D	½	50	3.8
	A210E	¾	50	3.7
	A210F	1	50	4.8

### 45° Stub-down

Carlton 45° stub-downs are designed to allow a smooth transition from cross deck ENT runs to vertical applications. The integral snaps provide a secure mount – preventing the ENT from slipping or pulling out – but also allow the stub to easily be removed. The underside of this fitting provides ample room to attach a Carlton coupling to the ENT to continue the run. Carlton 45° stub-downs are manufactured out of a highly engineered thermoplastic material to provide extra strength and durability. They're concrete-tight and available in sizes ½ in., ¾ in. and 1 in.

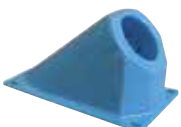
	Cat. no.	Size (in.)	Std. ctn. qty.	Std. ctn. wt. (lb)
	A220D	½	25	1.8
	A220E	¾	25	2.0
	A220F	1	25	2.6
	A220G	1¼	25	2.8
	A220H	1½	25	3.3
	A220J	2	25	4.1

### Vertical stub-down transition adapter

Carlton nonmetallic exclusive... Carlton vertical stub-down transition adapters like our vertical stub-downs, provide a means to transition from ENT to another wire management product where code requires other wire management means. The integral snaps provide a secure mount – preventing the ENT from slipping or pulling out, while the deck mount flange has a threaded port allowing connection to other conduit system using terminal adapter. Carlton vertical stub-down transition adapters are manufactured out of polycarbonate material to provide extra strength and durability. They're concrete-tight and available in sizes ½ in., ¾ in. and 1 in.

	Cat. no.	Size (in.)	Std. ctn. qty.	Std. ctn. wt. (lb)
	A200D	½	50	3.8
	A200E	¾	50	3.7
	A200F	1	50	4.8

### 90° Stub-down transition adapter

Carlton nonmetallic exclusive... Carlton 90° stub-downs are designed to allow a smooth transition from cross deck ENT runs to vertical applications where code requires other wire management means. The integral snaps provide a secure mount – preventing the ENT from slipping or pulling out, while the deck mount flange has a threaded port allowing connection to any conduit system using a terminal adapter. Carlton 90° stub-downs are manufactured out of polycarbonate material to provide extra strength and durability. They're concrete-tight and available in sizes ½ in., ¾ in. and 1 in.

	Cat. no.	Size (in.)	Std. ctn. qty.	Std. ctn. wt. (lb)
	<b>Female ENT to Female NPSC</b>			
	A230D	½	25	2.0
	A230E	¾	25	2.4
	A230F	1	25	3.3



## ENT accessories

### Transition adapters



**Male ENT to Schedule 40 PVC conduit**

Carlton exclusive...Carlton male ENT to Schedule 40 PVC conduit transition adapters are designed to connect Schedule 40 conduit to Carlton Flex-Plus Blue ENT boxes and fittings. Simply solvent cement the PVC adapter to the Schedule 40 conduit

and snap the adapter into the Carlton’s “quick connect” snap-in connector on the box or fitting. Carlton male ENT to Schedule 40 adapters are concrete-tight and available in sizes ½ in., ¾ in. and 1 in.



Cat. no.	Size (in.)	Std. ctn. qty.	Std. ctn. wt. (lb)
A263D	½ ENT to ½ Sch. 40	100	2.4
A263E	¾ ENT to ¾ Sch. 40	100	3.2
A263F	1 ENT to 1 Sch. 40	100	4.5



**ENT to EMT**

Carlton ENT to EMT transition adapters are designed to easily transition from Carlton Flex-Plus Blue ENT to EMT using Carlton’s “quick connect” snap-in design. The EMT is held securely in place using the small screw provided. This helps prevent

the EMT from slipping/shifting out of the adapter. All ENT to EMT adapters are manufactured out of polycarbonate material to provide extra strength and durability. They’re concrete-tight and available in sizes ½ in., ¾ in. and 1 in.



Cat. no.	Size (in.)	Std. ctn. qty.	Std. ctn. wt. (lb)
A245D	½ ENT to ½ EMT	100	3.4
A245E	¾ ENT to ¾ EMT	100	4.1
A245F	1 ENT to 1 EMT	100	5.4



**Reducer**

Carlton exclusive...Carlton ENT reducers are designed to provide an easy transition from 1 in. Carlton ENT to ¾ in. ENT or from ¾ in. Carlton ENT to ½ in. ENT. They’re concrete-tight and manufactured out of polycarbonate material to provide extra

strength and durability. Carlton ENT reducers provide flexibility while on the jobsite by minimizing the need to carry size-specific boxes and fittings. Carlton ENT reducers provide the versatility to convert Carlton fittings and boxes to many different sizes and configurations.



Cat. no.	Size (in.)	Std. ctn. qty.	Std. ctn. wt. (lb)
A273DE	¾ to ½	100	3.2
A273EF	1 to ¾	100	2.4

## ENT accessories

### Quick connect adapters and couplings

- Carlon one-piece ENT quick connect couplings, threaded adapters and snap-in terminator adapters are suitable for damp locations. Quick connect couplings and threaded adapters are concrete-tight when used with Carlon ENT.
- All sizes of rigid nonmetallic conduit fittings are compatible with ENT when using ENT cement.
- Rigid nonmetallic conduit fittings are recommended for use with Carlon 1¼ in. – 2 in. Flex-Plus Blue ENT.
- Use of ENT Blue quick-set cement is required. See [page 79](#) for details.
- When one-piece quick connect snap-in terminator adapters are installed in a concrete application, Carlon's flat sealing washers must be used on the box connection ends.

### Couplings



Cat. no.	Size (in.)	Std. ctn. qty.	Std. ctn. wt. (lb)
A240D	½	150	2.90
A240E	¾	100	3.00
A240F	1	50	2.30

### Threaded adapters



Cat. no.	Size (in.)	Std. ctn. qty.	Std. ctn. wt. (lb)
A243DC	½	150	2.55
A243EC	¾	100	2.30
A243FC	1	50	2.00



Cat. no.	Size (in.)	Std. ctn. qty.	Std. ctn. wt. (lb)
A253D	½	150	2.70
A253E	¾	100	2.90
A253F	1	50	2.30

## ENT accessories

### Rigid nonmetallic conduit adapters and couplings

All socket fittings should be attached using Carlon solvent cement. Using Carlon fittings with Carlon nonmetallic conduit ensures system integrity. Socket type for joining nonmetallic conduit.

#### Standard couplings



Cat. no.	Size (in.)	Std. ctn. qty.	Typical (in.)		Min. D (in.)	Max. O.D. (in.)	Typical (in.)		Std. ctn. wt. (lb)
			A	B			C	L	
CE940DR-CTN	½	150	0.852	0.836	0.728	1 <sup>7</sup> / <sub>64</sub>	1 <sup>1</sup> / <sub>16</sub>	1½	4.1
CE940ER-CTN	¾	100	1.064	1.046	0.840	1 <sup>5</sup> / <sub>16</sub>	¾	1 <sup>5</sup> / <sub>8</sub>	4.4
CE940F-UPC	1	50	1.330	1.310	1.210	1 <sup>5</sup> / <sub>8</sub>	1 <sup>5</sup> / <sub>16</sub>	2	3.5
E940G	1¼	30	1.677	1.655	1.535	1 <sup>63</sup> / <sub>64</sub>	1	2 <sup>3</sup> / <sub>8</sub>	3.5
E940H	1½	25	1.918	1.894	1.755	2 <sup>15</sup> / <sub>64</sub>	1 <sup>1</sup> / <sub>8</sub>	2 <sup>3</sup> / <sub>8</sub>	3.9
E940J	2	30	2.393	2.369	2.190	2 <sup>47</sup> / <sub>64</sub>	1 <sup>3</sup> / <sub>16</sub>	2½	5.3

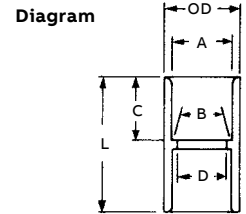

For adapting nonmetallic conduit to boxes threaded fittings, metallic systems. Male threads on one end, socket end on other.

#### Male terminal adapter



Cat. no.	Size (in.)	Std. ctn. qty.	Typical (in.)		Min. D (in.)	Max. O.D. (in.)	C	Typical (in.)		Std. ctn. wt. (lb)
			A	B				S	L	
E943D	½	150	0.852	0.836	0.597	1 <sup>1</sup> / <sub>8</sub>	5 <sup>1</sup> / <sub>16</sub>	9 <sup>1</sup> / <sub>16</sub>	1 <sup>7</sup> / <sub>16</sub>	2.8
E943E	¾	100	1.064	1.046	0.800	1 <sup>11</sup> / <sub>32</sub>	¾	9 <sup>1</sup> / <sub>16</sub>	1 <sup>3</sup> / <sub>8</sub>	3.5
E943F	1	50	1.330	1.310	1.018	1 <sup>1</sup> / <sub>8</sub>	1	1 <sup>1</sup> / <sub>16</sub>	1 <sup>25</sup> / <sub>32</sub>	3
E943G	1¼	30	1.677	1.655	1.332	2 <sup>1</sup> / <sub>32</sub>	1	¾	1 <sup>15</sup> / <sub>16</sub>	4
E943H	1½	25	1.918	1.894	1.566	2 <sup>5</sup> / <sub>32</sub>	1 <sup>3</sup> / <sub>16</sub>	¾	2 <sup>1</sup> / <sub>16</sub>	2.5
E943J	2	30	2.393	2.369	2.000	2 <sup>21</sup> / <sub>32</sub>	1 <sup>3</sup> / <sub>16</sub>	¾	2½	7

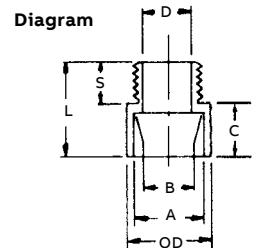

## Mud box assemblies

### Cement caps included

Carlton mud box assemblies are available in five unique styles... blank, ceiling ring, one-gang, two-gang and 4-inch square. All mud box assemblies are manufactured out of polycarbonate material to provide extra strength and durability, are

concrete-tight and have 12 integral connectors... two 1 in., six ¾ in. and four ½ in. Using our ENT reducers (see [page 67](#)), this product will meet any jobsite application.



### Mud box with ceiling ring

- Threaded brass inserts for fan (#10-32 screws) and fixture (#8-32 screws) mountings
- Listed for fixture support up to 50 lb
- Listed for ceiling fans up to 35 lb



Cat. no.	Description	Std. ctn. qty.	Std. ctn. wt. (lb)
A863CFG	Mud box with ceiling ring and ground lug	24	16.1



### Mud box with one-gang ring



Cat. no.	Description	Std. ctn. qty.	Std. ctn. wt. (lb)
A863SG	Mud box with one-gang ring and ground lug	24	16.2

## Mud box assemblies



### Mud box with two-gang ring

Cat. no.	Description	Std. ctn. qty.	Std. ctn. wt. (lb)
A863DG	Mud box with two-gang ring and ground lug	24	16.6



### Mud box assemblies with mounting feet

Carlson mud box assemblies with mounting feet are specifically engineered and designed for use in tunnel form applications. The mounting feet are located on all four corners and allow the box to attach directly to the wall of the form using pop rivets. The pop rivets help keep the box in position during the pour and provide a safe, secure and rust-resistant mount.

Cat. no.	Description	Std. ctn. qty.	Std. ctn. wt. (lb)
A863CFGF	Ceiling ring and ground lug	24	17.46
A863DGF	Double gang and ground lug	24	17.99
A863SGF	Single gang and ground lug	24	17.44

## Mounting brackets and ENT bridge

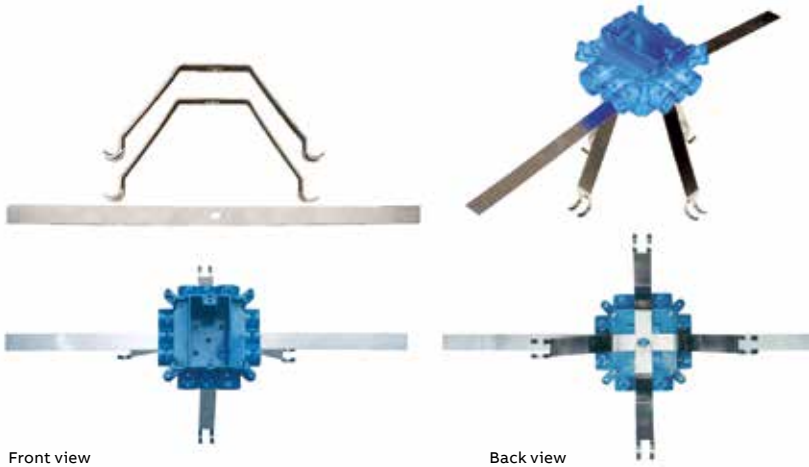

### Mounting brackets

Carlton exclusive...the Carlton ENT mounting bracket is specifically designed for use with Carlton ENT mud box assemblies in vertical concrete walls where one- or two-gang boxes are needed. The stainless steel spring-loaded mechanism provides a secure outlet box between concrete forms while the soft steel strap allows for the outlet box to be secured to rebar. The bracket combination assures a straight box opening and a concrete-tight fit. Mud box not included.

Cat. no.	Description	Std. ctn. qty.	Std. ctn. wt. (lb)
A863MB	Mud box mounting kit	1	0.98

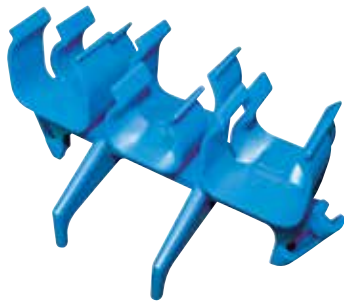

### ENT bridge

Carlton exclusive...The Carlton ENT bridge is designed to support long ENT runs in concrete pour applications. This makes pulling wire/cable a snap. Installation is easy. Simply mount the ENT bridge, using nails or screws, to the wood deck mounting and snap the ENT into place. The bridge is designed to hold the conduit in place while minimizing dips in the conduit over long runs. The Carlton ENT bridge is manufactured out of a highly engineered thermoplastic material to provide extra strength and durability and can accommodate ENT sizes ½ in., ¾ in. and 1 in. (The Carlton ENT bridge can be used with rigid nonmetallic conduit too.)

Cat. no.	Description	Std. ctn. qty.	Std. ctn. wt. (lb)
A293DEF	ENT bridge	50	9.0



## ENT technical information

### Concrete encasement guidelines

1. Cut ENT square and cleanly.
2. Insert end into fitting, making sure two (2) full corrugations are snapped into fitting beyond flexible tabs (2 clicks).
3. ENT should be tied to rebar at 2–3 foot intervals to prevent flotation. Keep ENT straight. Small deflections over a long run may accumulate significant degrees of bend, which will affect conductor installation. Suitable materials include wire, cable ties and tape.
4. When using rigid nonmetallic conduit fittings for concrete-tight performance:
  - A. Do not use chemical primer or cleaner.
  - B. Apply a light, uniform coat of cement labeled for use with ENT on the coupling and ENT.
  - C. Do not use a dauber.
  - D. Brush excess cement out of ENT grooves.
  - E. Promptly insert ENT into fitting while cement is wet, until the stop is reached, and give a quarter turn.
  - F. Do not disturb until joint is set.

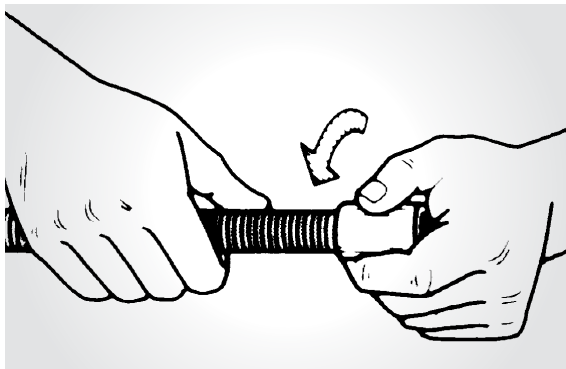
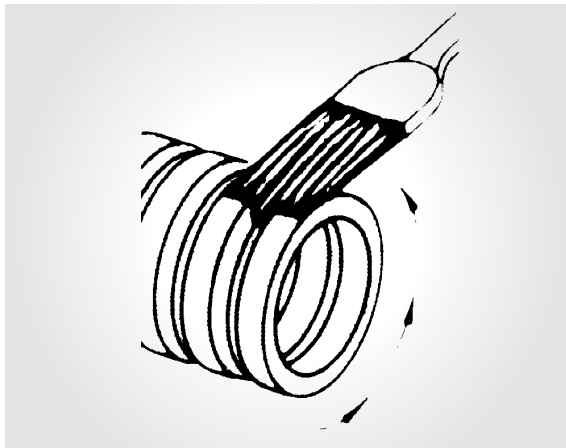

#### Features

- ENT rated for 75 °C Canada (90 °C conductors US and 75 °C Canada)
- Recognized for use with PVC rigid nonmetallic conduit fittings with all sizes of ENT
- One-piece ENT coupling, threaded terminator and RNC transition fitting are rated concrete-tight without tape
- Recognized for use in 2-hour fire resistive nonload bearing and load bearing wall assemblies
- Recognized for use in 1-hour fire resistive nonload bearing wall assemblies
- Recognized for use in a fire resistive ceiling assembly (up to 3 hours)
- Conductors easily push through the raceway (up to approximately 50 feet)
- For use in buildings in accordance with CEC Section 12-1500
- Outside diameters meet IPS dimensions
- Storage: -20 °C to 70 °C
- Handling: -20 °C to 40 °C

#### Typical applications

- Residential: Low or high rise – multi or single family
- Commercial: Low or high rise – office, retail, hotel/motel, restaurant, etc.
- Schools, classrooms, dormitories, offices
- Fire alarm systems
- Recreational vehicles and parks
- Solar photovoltaic systems
- Marinas and boatyards
- Other uses per the current CEC

## Low voltage brackets and kits

### Low voltage kit



The Carlton low voltage adjustable floor bracket is specifically designed for the low voltage, structured cabling market. The floor box is industry-standard orange to identify low voltage applications, the open design provides the space needed for low voltage bend radius requirements and the Leviton QuickPort® Quad 106® insert provides up to four low voltage outlets ports. The Carlton low voltage adjustable floor bracket is ideal for any residential or commercial low voltage application.

The floor bracket also features a patented screw design allowing it to be adjusted to most finished floor heights by simply turning the screw clockwise or counterclockwise and adjusting flush to the floor.

The floor bracket kit comes complete with a nonmetallic (white or ivory) or brass cover, a Leviton QuickPort Quad 106 insert, new work and old work metal mounting brackets and mounting screws.

- White, ivory or brass cover
- Orange – identifies low voltage installations
- Open design floor bracket – accommodates low voltage bend radius requirements
- Bracket adjusts to most finished floor depths
- Leviton QuickPort Quad 106 Insert – install up to 4 low voltage inserts
- Two-door design

Cat. no.	Cover	Std. ctn. qty.	Std. ctn. wt. (lb)
SC100FBWC	Nonmetallic – white	8	5.62
SC100FBVC	Nonmetallic – ivory	8	5.62
SC100FBBC	Brass	8	13.78

### Installation

01 Install clip over subfloor.

02 Screw in to adjust to height of flooring or carpet.

03 Beautiful flush fit every time.



01



02



03

## Low voltage brackets

### One-gang and two-gang – Low voltage

Cat. no.	Description	Size W x H (in.)	Std. ctn. qty.	Std. ctn. wt. (lb)
SC100ADJC	One-gang adjustable backless bracket	3 <sup>7</sup> / <sub>8</sub> x 3 <sup>3</sup> / <sub>4</sub>	24	7.5
SC200ADJC	Two-gang adjustable Backless bracket	5 <sup>5</sup> / <sub>8</sub> x 3 <sup>3</sup> / <sub>4</sub>	20	6.9



### Old work backless brackets – One-gang

Cat. no.	Description	Size (in.)	Std. ctn. qty.	Std. ctn. wt. (lb)
SC100RR	One-gang backless old work bracket with swing clamps	2 <sup>1</sup> / <sub>4</sub> x 3 <sup>3</sup> / <sub>4</sub>	12	1.4



### One-gang

Cat. no.	Description	Size (in.)	Std. ctn. qty.	Std. ctn. wt. (lb)
B100R-CRD	One-gang backless old work bracket with swing clamps	2 <sup>1</sup> / <sub>4</sub> x 3	12	1.4



### Two-gang

Cat. no.	Description	Size (in.)	Std. ctn. qty.	Std. ctn. wt. (lb)
SC200RR	Two-gang backless old work bracket with swing clamps	3.92 x 4.00	6	0.9



### Low voltage backless bracket

Open-backed to easily accommodate the bend radiuses required for low voltage cabling and deep devices such as volume controls and is designed to fit a standard one-gang faceplate. It also features an easy nail-on mounting or screw-in bracket, while the hard shell provides increased durability and no racking. Resi-Rings accept <sup>3</sup>/<sub>4</sub> in., 1 in. and 1<sup>1</sup>/<sub>4</sub> in. Resi-Gard.

Cat. no.	Description	Size W x H (in.)	Std. ctn. qty.	Std. ctn. wt. (lb)
SC100A	One-gang backless bracket	2.32 x 3.73	24	7.5
SC200A	Two-gang backless bracket	5.35 x 3.81	24	7.7
SC300A	Three-gang backless bracket	8.69 x 7.20	5	1.6

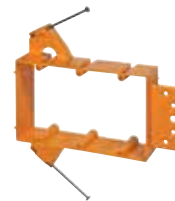

### Low voltage add-on bracket

This low voltage bracket provides a low voltage outlet next to a previously installed high voltage outlet. Great for both new construction and rework, it attaches easily to most electrical boxes and is designed to fit a standard two-gang faceplate. Resi-Rings accept <sup>3</sup>/<sub>4</sub> in. Resi-Gard only

Cat. no.	Description	Size W x L (in.)	Std. ctn. qty.	Std. ctn. wt. (lb)
SC100SC	One-gang add-on bracket	1.80 x 3.68	24	2.3



---

## 3-Gang recessed plate

The Carlon RDV 3-gang old work plate, cat. no. CSC300PR, has been developed to simplify today's in-home entertainment/networking needs. The box is designed to accommodate the wires, cables and cords used with flat panel display installations.

It features a two-gang low voltage opening and a one-gang opening complete with device box (devices and plates not included).

The high-gloss, recessed design eliminates unsightly wires, cables and cords and blends with any décor. The RDV old work plate makes installing flat panel displays faster and easier.



## 3-Gang recessed plate

### Features

- 3-Gang dual service capability: Accommodates (1) high and (2) low voltage services using one plate (boxes, devices and plates not included)
- Recessed low profile design: Eliminates unsightly wires and plug heads
- Universal 1-gang outlet / switch opening: Including the box you need
- Pre-assembled box and frame: Reduces labor time and saves money
- Shallow design: Provides ample room behind the dry wall and between the studs and accommodates cable bend requirements
- 4 Swing-out clamps: Locks the plate securely to the wall – horizontal or vertical mount
- Superior high-gloss, paintable finish: Professional appearance, blends with any décor
- Nonmetallic, ABS material: Lightweight and easy to handle

### Specifications

Cat. no.	Description	Std. carton qty.	Std. carton wt. (lb)
CSC300PR	RDV 3-gang old work plate with outlet box	6	4.84

### Diagrams

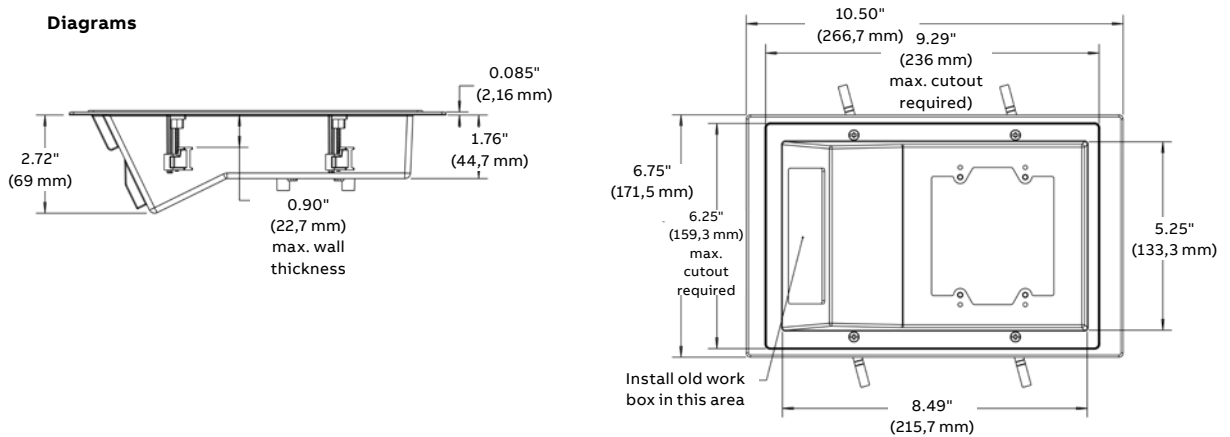

### Installed



Top view showing ample room between drywall and studs.

## Cements



### Medium – Clear

Recommended pipe application and sizes	Set-up time (evaporation rate)	Recommended installation temp.	Lap shear @ 23 °C	Viscosity at 24 °C as manufactured (cps)
Recommended for all grades and types of Carlon PVC conduit, duct, wireway and fittings, except Flex-Plus Blue ENT (electrical nonmetallic tubing.) Up through 6 in. diameter.	Under -12 °C: not recommended -1 to 10 °C: 5–6 minutes 10 to 21 °C: 3–4 minutes 21 to 32 °C: 1–2 minutes	5 °C to 37.7 °C	2 hrs. 350 psi 16 hrs. 800 psi 72 hrs. 1,500 psi	500–900

Cat. no.	Size (ml)	Applicator	Description	Ctn. qty.	Ctn. wt. (lb)
VC9963C	473	Dauber	PVC medium clear	24	29.0



### Regular – Clear

Recommended pipe application and sizes	Set-up time (evaporation rate)	Recommended installation temp.	Lap shear @ 23 °C	Viscosity at 24 °C as manufactured (cps)
Recommended for all grades and types of Carlon PVC conduit, duct, wireway and fittings, except Flex-Plus Blue ENT (electrical nonmetallic tubing.) Up through 6 in. diameter.	Under -12 °C: not recommended -1 to 10 °C: 5–6 minutes 10 to 21 °C: 3–4 minutes 21 to 32 °C: 1–2 minutes	5 °C to 37.7 °C	2 hrs. 350 psi 16 hrs. 800 psi 72 hrs. 1,500 psi	500–900

Cat. no.	Size (ml)	Applicator	Description	Ctn. qty.	Ctn. wt. (lb)
VC9965C	118	Dauber	PVC regular clear	24	8.4

## Cements



### All weather – “Quick-set” cement

Recommended pipe application and sizes	Set-up time (evaporation rate)	Recommended installation temperature	Lap shear @ 23 °C	Viscosity at 24 °C as manufactured (cps)
Recommended for all grades and types of Carlon PVC conduit, duct, wireway and fittings, except Flex-Plus Blue ENT (electrical nonmetallic tubing.) Up through 6 in. diameter.	-20 to -12 °C: 6–8 minutes	-20 °C to 37.7 °C	2 hrs. 350 psi 16 hrs. 800 psi 72 hrs. 1,500 psi	400–700
	-12 to -1 °C: 4–5 minutes			
	-1 to 10 °C: 3–4 minutes			
	10 to 21 °C: 1–2 minutes			
	21 to 32 °C: ½–1½ minutes			

Cat. no.	Size (ml)	Applicator	Ctn. qty.	Ctn. wt. (lb)
VC9983C	473	Dauber	24	30.0
VC9985C	118	Dauber	24	7.5

Meets ASTM D-2564

## Primers

### Multi-purpose spray-on PVC cement

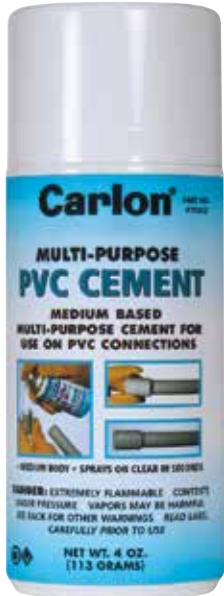

#### No waste • sprays on in seconds • fast setting

- Equivalent to a medium-bodied low-VOC, quick setting clear cement
- No more spills
- Reuse can until empty
- Installation: 10 °C to 26 °C  
Storage: 1 °C to 48 °C
- Meets ASTM D-2564
- 3-year shelf life
- One 120 ml can is equivalent to 120 ml of non-aerosol PVC cement\*

\*Equivalence is subject to usage and will vary

#### Applications

- For use with up to 4 in. dia. Schedule 40 PVC electrical conduit.
- For use with PVC raceways only. Not recommended for use on water, sewer, natural gas, compressed gas or air connections.

Temperature range	Recommended set time		
	Pipe sizes ½ in. to 1¼ in.	Pipe sizes 1½ in. to 2 in.	Pipe sizes 2½ in. to 4 in.
15 to 37.7 °C	2 min.	5 min.	30 min.
4 to 15 °C	5 min.	10 min.	2 hrs.
-17 to 4 °C	10 min.	15 min.	12 hrs.

Recommended set time may vary depending on humidity

Cat. no.	Size (ml)	Ctn. qty.	Ctn. wt. (lb)
VC9AC5C	120	12	5.6



## Sealers

### Multi-purpose Weather-Gard™ spray-on rubber film



**No waste • sprays on in seconds • fast setting**

- Weatherproof
- Forms a protective weatherproof seal on electrical connections
- Dries in minutes to crystal-clear rubber film
- Prevents corrosion on electrical connections
- Recommended installation temperatures 10 to 26 °C
- Can be used on wood and plastic
- 2-year shelf life

**Applications**

- Electrical connections
- Outdoor lighting
- Panel boxes
- Pool motors and timers
- Water valves and connections
- Sprinkler connections and control box
- Marine applications

Cat. no.	Size (ml)	Ctn. qty.	Ctn. wt. (lb)
VC9WG5C	120	12	5.6

### Multi-purpose spray-on rubber thread gasket



**No waste • sprays on in seconds • fast setting**

- Dries to rubber gasket to seal pipe threads
- Seals out leaks
- Protects against rust and corrosion
- UV resistant
- Weatherproof
- 2-year shelf life

**Applications**

- PVC
- Copper
- Iron
- Brass

Cat. no.	Size (ml)	Ctn. qty.	Ctn. wt. (lb)
VC9TS5C	120	12	5.6

## Installation instructions

### Cement joints

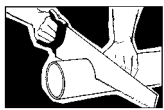

Carlton nonmetallic products are joined by means of solvent cement joints. Sizes ½ in. through 1½ in. should be cut square (using a fine tooth handsaw) and deburred.



For sizes 2 in. through 6 in. a miter box or similar saw guide should be utilized to keep the material steady. After cutting and deburring, wipe ends clean of dust, dirt and shavings.

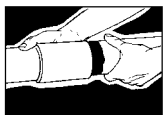
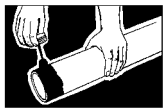

Joining process as follows: Be sure that conduit end is clean and dry. Apply coat of Carlton solvent cement (use dauber) to end of conduit, the length of the socket to be attached. Push conduit firmly into fitting while rotating conduit slightly about one-quarter turn to spread cement evenly. Allow joint to set approximately 10 minutes.

Carlton recommends the use of Carlton cement for proper solvent cement joints. Since this cement is prepared particularly for our product compounds and tolerances, we cannot guarantee joints assembled with cement materials supplied by other manufacturers. Regular-grade grey solvent cement will accommodate most application situations, being of a general purpose nature. In situations requiring an extremely fast-setting joint (low temperature or difficult installation conditions), Carlton all weather quick-set cement is recommended. Standard-grade clear cement is recommended for non-critical utility applications where gap filling and leak testing are not required.

#### Average number of joints per can

Trade size (in.)	237 ml	473 ml	946 ml	3.78 L	120 ml	480 ml
½	140	275	550	2,200	70	275
¾	90	180	360	1,440	45	180
1	70	140	280	1,120	35	140
1¼	50	100	200	800	25	100
1½	37	75	150	600	18.5	75
2	20	40	80	320	10	40
2½	17	35	70	280	8.5	35
3	15	30	60	240	7.5	30
3½	13	27	54	216	6.5	27
4	12	25	50	200	6	25
5	9	19	38	150	N/A	N/A
6	6	12	24	95	N/A	N/A

Can: Average shelf-life of all Carlton cement is 24 months (unopened cans stored below 26° C.)

Spray: Average shelf-life of all Carlton spray PVC cement is 3 years.

All Carlton cements are specially formulated to be used with Carlton PVC products, and do not require primers when parts are clean of dirt and moisture.



#### Cementing PVC conduit

1. Make square saw cut with fine tooth saw.
2. Deburr and round inside edge of the cut end.
3. Clean socket ID and spigot OD of dirt and moisture.
4. Apply a uniform coat of cement to spigot end and push onto socket bottom, rotating ¼ turn.
5. Allow time to set before disturbing. This will depend upon temperature.

#### Cementing PVC conduit for submerged areas requiring air or water tightness

1. Follow the procedure outlined above for cementing conduit.
2. Test workmanship by conducting a low pressure air (3.0–5.0 psi) test after system is installed and cemented joints are set.
3. Plug and block ends to prevent movement prior to pressurization.
4. Check for leaks with soap solution.
5. Even low pressure air can cause high thrust loads, and caution must be observed.

#### Cementing ENT for concrete-tight applications

1. Use Carlton socket tight fittings or couplings.
2. Do not use chemical primer or cleaner.
3. Apply a light uniform coat of cement, labeled for use with ENT.
4. A brush shall be used to apply the cement.
5. Brush excess cement out of ENT grooves.
6. Promptly insert ENT into fitting while cement is wet, until the fitting stop is reached, and give ¼ turn.
7. Do not disturb until the joint is set.

**Conduit cutters**



**Kwikcut cutter**

For fast, smooth field cuts of ½ in. through 1 in. innerduct.

Cat. no.	Length (in.)	Std. ctn. qty.
CC120B	8	10



**Medium cutter**

Hand-held cutter makes fast, square, smooth field cuts on innerduct sizes ½ in. through 1¼ in.

Cat. no.	Length (in.)	Std. ctn. qty.
CC125	9	1



**Large cutter**

For clean cuts of innerduct sizes ½ in. through 2 in.

Cat. no.	Length (in.)	Std. ctn. qty.
CC122	17½	1

## EZ BEND conduit bending equipment

01 For field bending of small and large diameter nonmetallic conduit, the easy answer is Carlon EZ BEND conduit bending equipment.



—  
01

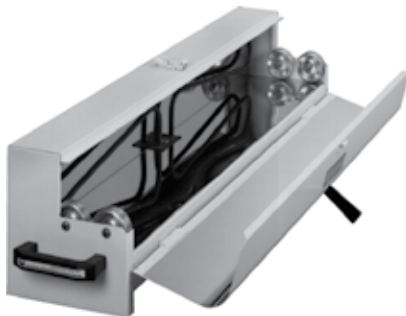

### **EZ BEND Conduit Bender, Jr.**

A practical, convenient, portable conduit bender for ½ in. through 2 in. diameter nonmetallic conduit allows bends up to 14 in. radius and to 90° elbows. The EZ BEND Conduit Bender, Jr. is a time-saving, easy-to-carry unit featuring a bracket to store the power cord, a carrying handle and a clasped cover. The unit operates on a standard 20 amp, 120 V circuit.

- Dimensions: 7½ in. x 8½ in. x 31 in.
- Operating temperature: 82 °C to 93 °C

Carlon's EZ BEND conduit bending equipment is designed with the electrical contractor in mind. The completely portable and fully encased EZ BEND benders and plug kits can be transported from job to job without damage or harm to the equipment. Additionally, the heavy-duty construction and integrity of Carlon's EZ BEND conduit bending equipment ensures that it will last for years to come.

- Lightweight
- Fast, simple and safe
- Includes complete instructions and a convenient bending chart
- Portable
- Less expensive than factory bends

Cat. no.	Std. ctn. qty.	Std. ctn. wt. (lb)
G280J	1	10

EZ BEND is a registered trademark of Bradshaw Manufacturing, Inc.

## EZ BEND conduit bending equipment

—  
02 Minimum practice is required to master the three steps in bending nonmetallic conduit and ducts.



—  
02

### Field bending rigid nonmetallic conduit

#### 1. Heating

Conduit section to be bent must be heated evenly over the entire length of the curve. Carlon offers EZ BEND electric heaters designed specifically for the purpose, in sizes to accommodate all conduit diameters. These devices employ infrared heat energy, which is most quickly absorbed by the conduit. Small sizes are ready to bend after a few seconds, while larger diameters require two or three minutes, or more depending on conditions. The use of torches or other flame-type devices is not recommended. PVC conduit exposed to excessively high temperatures may take on a brownish colour. Sections showing evidence of such scorching should be discarded.

#### 2. Forming the bend

$\frac{1}{2}$  in. through 1½ in. diameters – When properly heated the conduit is very flexible and can be shaped to almost any configuration. The conduit is then cooled by sponging with water, and the bend is ready to install.

2 in. and larger diameters – Larger sizes of conduit and ducts require internal support to prevent “crimping” or deforming during the bending process. Bending plugs are inserted in each end of the conduit section before heating. The plugs expand to provide an airtight seal. (Note: Carlon does not offer bending plugs.)

#### 3. Cooling

As the conduit is heated, the retained air expands, and the increased internal pressure allows the conduit to be bent without deforming. The conduit must be cooled before the plugs are removed. For an immediate cool and set, sponge with cold water.

### Special bends

For “blind” bends or for compound turns in a conduit run, the heated conduit may be solvent cemented in place while still flexible.

# PV-Mold

## Nonmetallic pole riser system



RUS accepted

01 Slots are 1/2 in. from side to side to allow for expansion and contraction. Slot dimensions for sizes 2 in. through 6 in. are 3/16 in. wide, 3/4 in. long. Slot dimensions for 1 in. and 1 1/2 in. are 1/8 in. wide, 3/4 in. long. Slot spacing: 18 in. from center, beginning 6 in. from end.



01

Carlson PV-Mold is a non-metallic pole riser system designed to protect communications or power cable installed on poles.

### Features

- Meets or exceeds requirements outlined in the National Electric Safety Code (NECS)
- Designed in accordance with NEMA TC-19 specifications
- Ultraviolet, cold temperature and corrosive atmosphere resistant
- No grounding required
- Belled end fits over each added section or conduit
- Requires no maintenance
- PV-Mold acts as an insulator against electrical shock
- Interchangeable parts and accessories to match the needs of specific requirements

Size (in.)	Depth of bell (in.)
1	2-2 1/4
1 1/2	2-2 1/4
2	2-2 1/4
3	3-2 1/4
4	4-2 1/4
5	4-2 1/4
6	5 - 2 1/4

Cat. no.	Size (in.)	Std. ctn. qty.	Std. ctn. wt. (lb)	Dimensions (in.)				Actual impact @ 0 °C 20 lb tup
				A	B	C	H	
<b>Standard duty</b>								
59208N	1	294	1,059	0.100	1 5/8	2 3/8	1 5/8	40 ft.-lb
59211N	2	136	726	0.100	2 3/8	4 1/2	2 3/8	100 ft.-lb
59213N	3	66	761	0.150	3 1/2	6	3 1/2	110 ft.-lb
59215N	4	65	910	0.150	4 1/2	6 1/2	4 1/2	110 ft.-lb
59216N	5	30	515	0.150	5 1/2	7 1/2	5 1/2	110 ft.-lb

### Diagram

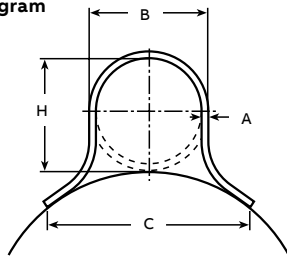

Flanged overall length 10 feet, including bell

Cat. no.	Size (in.)	Std. ctn. qty.	Std. ctn. wt. (lb)	Dimensions (in.)				Actual impact @ 0 °C 20 lb tup
				A	B	C	H	
<b>Heavy duty schedule 40</b>								
59010N	1 1/2	200	1,142	0.145	1 2 9/32	3 1/2	1 2 9/32	100 ft.-lb
59011N	2	136	1,214	0.154	2 3/8	4 1/2	2 3/8	150 ft.-lb
59013N	3	66	934	0.216	3 1/2	6	3 9/32	150 ft.-lb
59015N	4	65	1,621	0.237	4 1/2	6 1/2	4 1/2	260 ft.-lb
59016N	5	30	870	0.258	5 1/2	7 1/2	5 1/2	260 ft.-lb
59017N	6	30	1,160	0.280	6 5/8	8 3/4	6 5/8	260 ft.-lb

# PV-Mold

## Polyethylene vented boots and adapters

Cat. no.	Size (in.)	Std. ctn. qty.	Std. ctn. wt. (lb)	Dimensions (in.)			
				A	B	C	D
<b>Vented boots</b>							
E938JR	2 x 6	4	13.5	20.50	4.80	6.13	6.20
E938NT	4 x 8	4	21.0	21.00	15.00	11.34	9.76

Diagrams

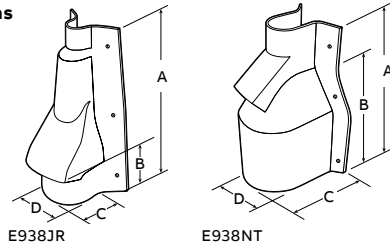

1. A field cut may be needed to accommodate different boot or adapter to Carlon U-Mold size combinations.
2. Recommendation: 2 sets of mounting holes per boot/ fitting. To add mounting holes, use a 3/8 in. drill bit and drill out where needed.
3. When 3 in. or smaller conduit is being used, it's recommended that the bottom (largest section) of the boot or adapter section be buried 2 in. to 3 in. below ground surface.

Cat. no.	Size (in.)	Std. ctn. qty.	Std. ctn. wt. (lb)	Dimensions (in.)				
				A	B	C	D	E
<b>Vented boots</b>								
E938NRR	4 x 6	6	26.4	20.87	16.57	12.87	11.68	11.43
E938PRR	5 x 6	6	23.2	16.74	3.65	10.84	11.43	-

Diagrams

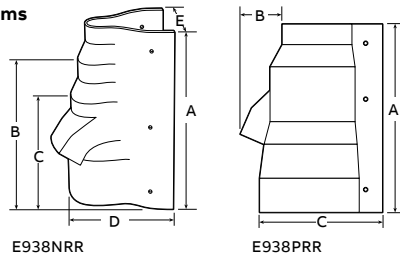

Cat. no.	Size (in.)	Std. ctn. qty.	Std. ctn. wt. (lb)	Dimensions (in.)			
				A	B	C	D
<b>Adapters</b>							
E939JN	2 x 4	8	10.0	11.00	6.75	5.88	5.07
E939NR	4 x 6	6	11.7	11.00	6.75	7.08	7.13

Diagrams

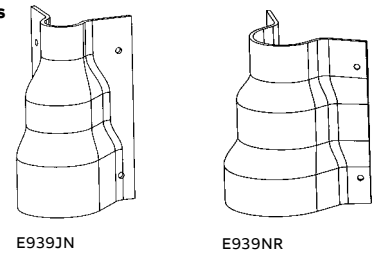

Cat. no.	Size (in.)	Std. ctn. qty.	Std. ctn. wt. (lb)	Dimensions (in.)				
				A	B	C	D	E
<b>Adapters</b>								
E939NRT	4 x 6	3	14.0	19.75	4.25	12.50	8.50	7.40

Diagrams

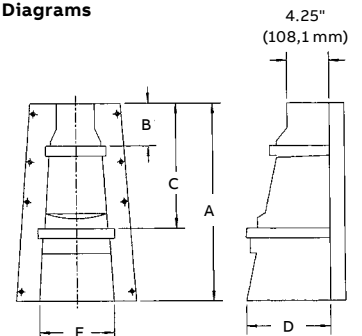

Cat. no.	Size (in.)	Std. ctn. qty.	Std. ctn. wt. (lb)
<b>Duct to riser fitting</b>			
E939NL	4 x 3	15	5.6
E939N	4 x 4	15	5.3

## PV-Mold

### Installation instructions

#### Installation is easy with PV-Mold pole risers

1. Install ventilator or duct to riser fittings at the base of the pole.
2. Nail backing plate sections to the surface of the pole. Three nail holes are provided in each section. Place the "U" sections over the cable and backing plate, with belled end at the bottom and attach using  $\frac{1}{4}$  in. lag bolts.

#### Field installation instructions for Carlon PV-Mold adapters

##### For adapters E939JN, E939NR, E939NRT

#### E939JN

To transition from 4 in. conduit to 2 in. PV-Mold, place adapter over conduit, attach to pole using the top and bottom mounting holes, place PV-Mold over top section of adapter and secure PV-Mold to pole.

To transition from 4 in. conduit to 3 in. PV-Mold, measure 6.3 in. up from bottom (large end) of adapter and cut. Assemble to pole as described above.

To transition from 3 in. conduit to 2 in. PV-Mold\*, measure 4.75 in. up from bottom (large end) of adapter and cut. Assemble to pole as described above.

#### E939NR

To transition from 5 in. conduit to 4 in. PV-Mold, place adapter over conduit, attach to pole using the top and bottom mounting holes, place PV-Mold over top section of adapter and secure PV-Mold to pole.

To transition from 6 in. conduit to 5 in. PV-Mold, measure 7.25 in. up from bottom (large end) of adapter and cut. Assemble to pole as described above.

To transition from 5 in. conduit to 5 in. PV-Mold\*, measure 4.5 in. down from the top of adapter and cut. Assemble to pole as described above.

\*For these transitions, it is not necessary to cut the adapter. If the adapter is not modified, it is recommended that the bottom 3 in. of the adapter be buried below grade.

#### E939NRT

To transition from 6 in. conduit to 4 in. PV-Mold, place adapter over conduit and attach to pole using the top and bottom mounting holes, place PV-Mold over top section of adapter and secure PV-Mold to pole.

To transition from 6 in. conduit to 5 in. PV-Mold, measure 5.25 in. down from the top of the adapter and cut. Assemble to pole as described above.

To transition from 6 in. conduit to 6 in. PV-Mold, measure 9.5 in. up from the bottom of the adapter and cut. Assemble to pole as described above.

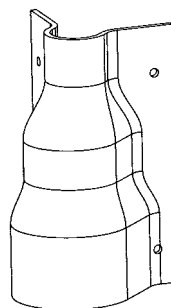
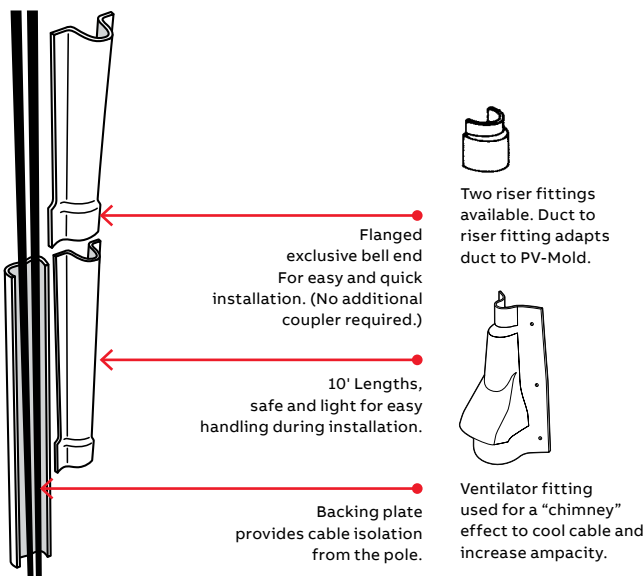

E939JN

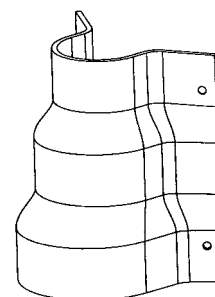

E939NR

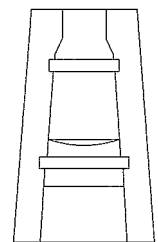

E939NRT



## PV-Mold

### Installation instructions

#### Field installation instructions for Carlon PV-Mold vented boots

##### For vented boots E938JR, E938NT, E938NRR, E938PRR

###### E938JR

To transition from 5 in. or smaller conduit to 2 in. PV-Mold, place vented boot over conduit, attach to pole using the top and bottom mounting holes, place PV-Mold over top section of vented boot and secure PV-Mold to pole.

To transition from 5 in. or smaller conduit to 3 in. and larger PV-Mold:

- For 3 in. PV-Mold: Measure 3.75 in. from the top of the boot and cut. Place the boot over the conduit and attach to the pole. Place belled end of PV-Mold over the top end of the boot and secure.
- For 4 in. and 5 in. PV-Mold: Measure 12 in. up from the bottom of the boot and cut. Place the boot over the conduit and attach to the pole. Place the belled end of the PV-Mold against the top edge of the vent protrusion and secure to the pole.

###### E938NT

To transition from 6 in. to 8 in. conduit to 4 in. PV-Mold, place boot over conduit and attach to the pole using the mounting holes.

Place PV-Mold over top section of vented boot and secure to the pole.

It is recommended that for conduit sizes smaller than 8 in., the bottom 3 in. of the boot be buried below grade. The E938NT can also be used to transition multiple smaller conduit to PV-Mold.

###### E938NRR

To transition from 6 in. or smaller conduit to 4 in. PV-Mold, place vented boot over conduit and attach to pole using the top and bottom mounting holes. Place PV-Mold over top section of vented boot and secure PV-Mold to pole.

To transition from 6 in. or smaller conduit to 5 in. PV-Mold, measure 4.125 in. down from the top of the vented boot and cut. Assemble to pole as described above.

To transition from 6 in. or smaller conduit to 6 in. PV-Mold, measure 8.25 in. down from the top of the vented boot and cut. Assemble to pole as described above.

###### E938PRR

To transition from 6 in. or smaller conduit to 5 in. PV-Mold, assemble to pole as described above.

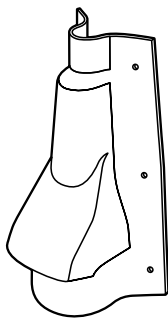

E938JR

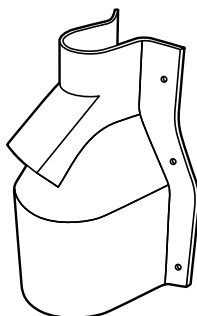

E938NT

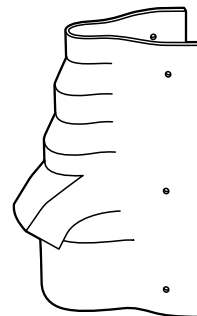

E938NRR

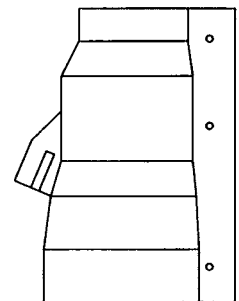

E938PRR

