



Aluminum cable tray

Overview

Features

- Straight side rail design: Extruded I-beam; nominal height 4 in. to 8 in.; loading height 3 in. to 7 in.
- Snap-in splice plate connection
- Reverse position of every other rung for bottom or top mounting of cable ties
- Versatile continuous open slot rungs (strut profile)
- Holes spaced 1 in. designed based on the exclusive Ty-Rap® cable tie slots ($\frac{5}{8}$ x $\frac{5}{8}$)
- Extra wide rung
- Four bolt connection
- Choice of two styles of fitting (U and H) side rails

Applications

Commercial:

- Schools
- Hospitals
- Office buildings
- Airports
- Casinos
- Stadiums

Industrial:

- Petrochemical plants
- Automotive plants
- Paper plants
- Food processing
- Power plants
- Refineries
- Manufacturing
- Mining

Accessories

- Each pair of splice plates comes with $\frac{3}{8}$ in. mounting hardware
- Complete line of accessories and support systems

Material

- 6063 aluminum alloy

Compliance

- CSA, NEMA, NEC, UL

Load ratings

- 1.5 safety factor. All tray sections will support an additional 200 lb concentrated load on any portion of tray (side rail, rung, etc.) above and beyond published load class.

Aluminum cable tray

Straight lengths



Tray bottom types: ladder, ventilated and solid trough

Ladder

Extra wide aluminum rungs are welded to extruded aluminum I-beam side rails. Every second rung is reversed to allow for easy top or bottom mounting of cable ties and clamps. All edges and welds are rounded and smooth to prevent cable damage.

Ventilated*

A fabricated structure consisting of integral or separate longitudinal rails and a bottom having openings sufficient for the passage of air and utilizing 75% or less of the plan area of the surface to support cables. The maximum open spacings between cable support surfaces of transverse elements do not exceed 102 mm (4 in.) in the direction parallel to the tray side rails (rung edge to rung edge).

Solid trough**

A fabricated structure consisting of a bottom without ventilation openings within separate longitudinal side rails.

* For load CSA class C/3M, NEMA 8C or less, please see alternative ventilated series of cable tray called One-Piece found on pages A174 to A207 of the catalogue.

** Fast and easy snap-in splice plates are provided with each straight section.

Straight lengths number selection

How to create part numbers

ABB has created a numbering system based on the order of selection criteria. For example, the first selection issue is the environment to which the cable tray will be subjected. This selection will lead to the best material for your application. For complete details on the cable tray selection process, see page A9 in the technical section.

Methods

1. Select the material best suited to your environment. Refer to technical section page A9.
2. Determine the tray series using the NEMA/CSA load/span designations page A16, and sizing cable tray page A23.
3. Select nominal depth and width of tray based on cable loading. See sizing cable tray page A23.
4. Select the bottom type based on cables and spacing requirements.
5. The last number is the length of the cable tray in meters or inches.

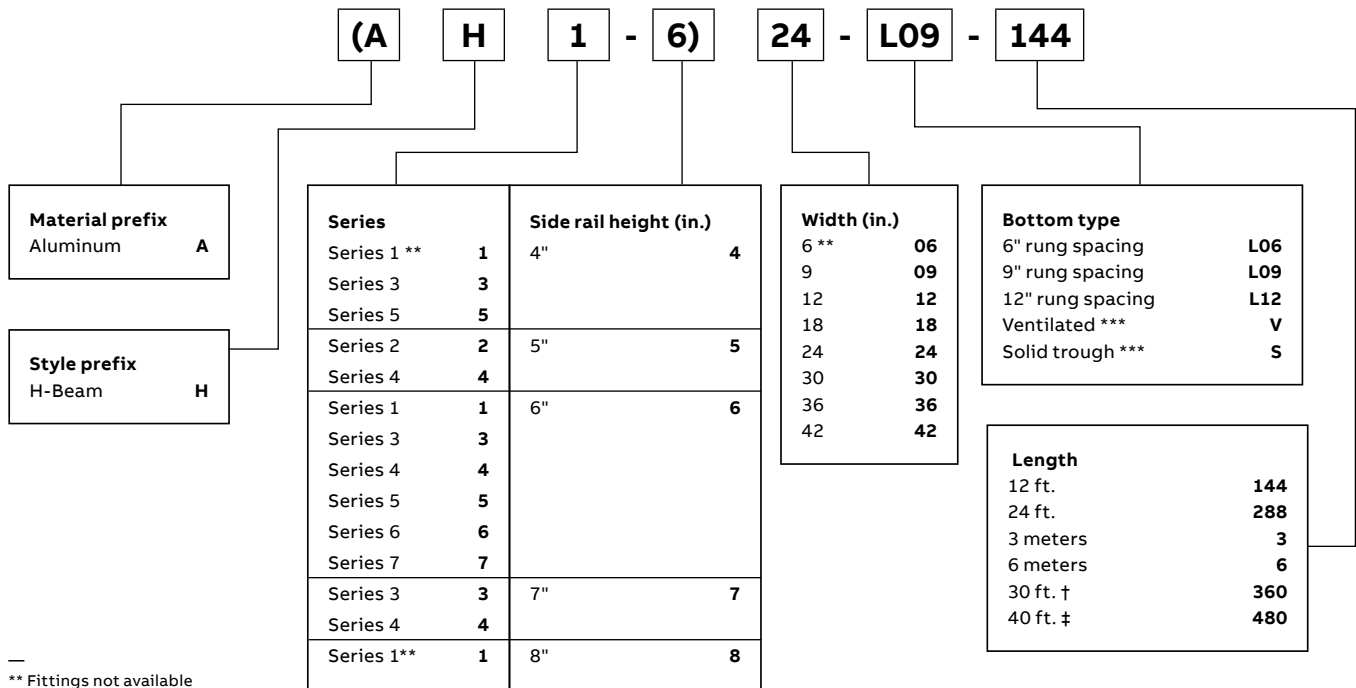

** Fittings not available for 8 in. side rail series 1.

*** For load CSA Class C/3M, NEMA 8C or less, please see an alternative ventilated series of cable tray called One-Piece found on pages A174 to A207 of this catalogue. Not offered in 40 ft. length.

† For series 76, 47 and 18 only.

‡ Only offered with series 1, 8 in. side rail height, width between 12 to 36 in.

Aluminum straight lengths

4 in. Straight sections/series 1-4 – Ladder, ventilated and solid trough



Technical specifications

All calculations and data are based on 42 in. wide cable trays with rungs spaced on 12 in. centers with tray supported as simple spans with deflection measured at the midpoint. Continuous spans may reduce deflection by as much as 50%.

Deflection factor: For lighter loads, deflection can be calculated by multiplying the load by the deflection factor.

4 in. Straight sections/series 1-4 – Ladder, ventilated and solid trough

Series		Support span (feet)							
		6	8	10	12	14	16	18	20
AH1-4	Load (lb)/ft.)	300	169	108	75	-	-	-	-
	Deflection (in.)	0.339	0.602	0.94	1.354	-	-	-	-
	Deflection factor	0.0011	0.0036	0.0087	0.0181	-	-	-	-

Straight section number selection

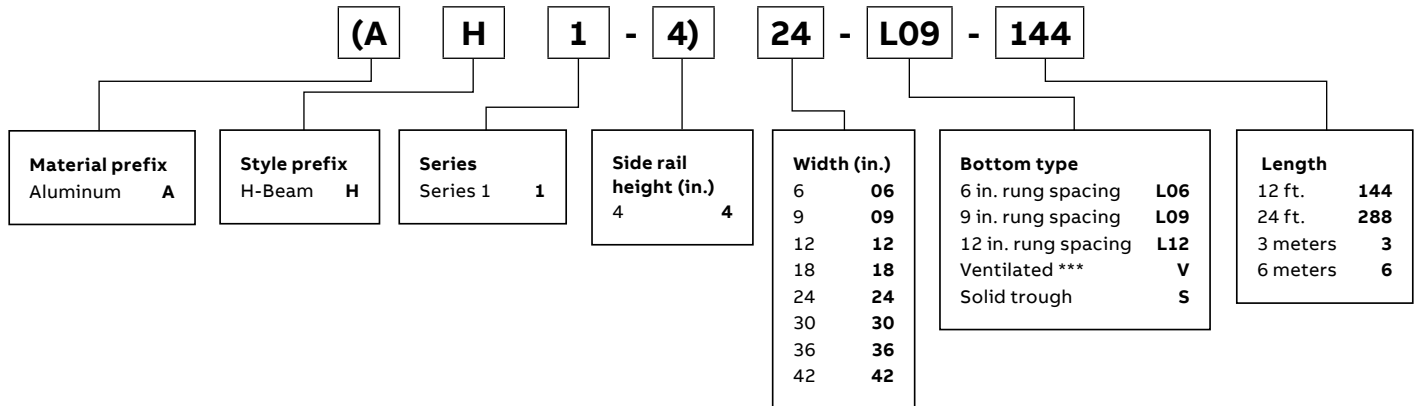

*** For load CSA class C/3M, NEMA 8C or less, please see an alternative ventilated series of cable tray called One-Piece found on pages A174 to A207 of this catalogue.

For fittings, consult pages A48 to A98.

Dimensions

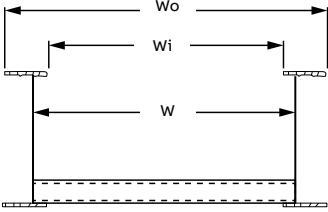
			AH1-4
			Wi (in.)
	W (in.)	Wo (in.)	
	6	8.86	4.86
	9	11.86	7.86
	12	14.86	10.86
	18	20.86	16.86
	24	26.86	22.86
	30	32.86	28.86
	36	38.86	34.86
	42	44.86	40.86

Technical specifications

Load ratings: 1.5 safety factor. All tray sections will support an additional 200 lb concentrated load on any portion of tray (side rail, rung, etc.) above and beyond published load class.

Load ratings: 1.5 safety factor

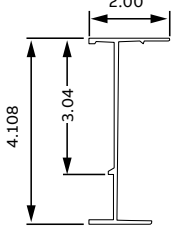
		Side rail design factors 1 pair			Classifications	
	Series		NEMA	CSA		
					UL	
	AH1-4	AH1-4	$I_x = 2.58 \text{ in.}^4$ $S_x = 1.22 \text{ in.}^3$ Area = 0.97 in.^2	12B, 8C	C/3m	UL cross sectional area: 0.60 in.^2

Aluminum straight lengths

4 in. Straight sections/series 3-4, 5-4 – Ladder, ventilated and solid trough



Technical specifications

All calculations and data are based on 42 in. wide cable trays with rungs spaced on 12 in. centers with tray supported as simple spans with deflection measured at the midpoint. Continuous spans may reduce deflection by as much as 50%.

Deflection factor: For lighter loads, deflection at any length can be calculated by multiplying the load by the deflection factor.

4 in. Straight sections/series 3-4, 5-4 – Ladder, ventilated and solid trough

Series		Support span (feet)							
		6	8	10	12	14	16	18	20
AH3-4	Load (lb)/ft.)	567	319	204	142	104	80	63	51
	Deflection (in.)	0.473	0.842	1.315	1.894	2.578	3.367	4.261	5.261
	Deflection factor	0.0008	0.0026	0.0064	0.0134	0.0248	0.0423	0.0677	0.1032
AH5-4	Load (lb)/ft.)	1044	588	376	261	192	147	116	94
	Deflection (in.)	0.572	1.017	1.588	2.287	3.113	4.066	5.147	6.354
	Deflection factor	0.0005	0.0017	0.0042	0.0088	0.0162	0.0277	0.0443	0.0676

Straight section number selection

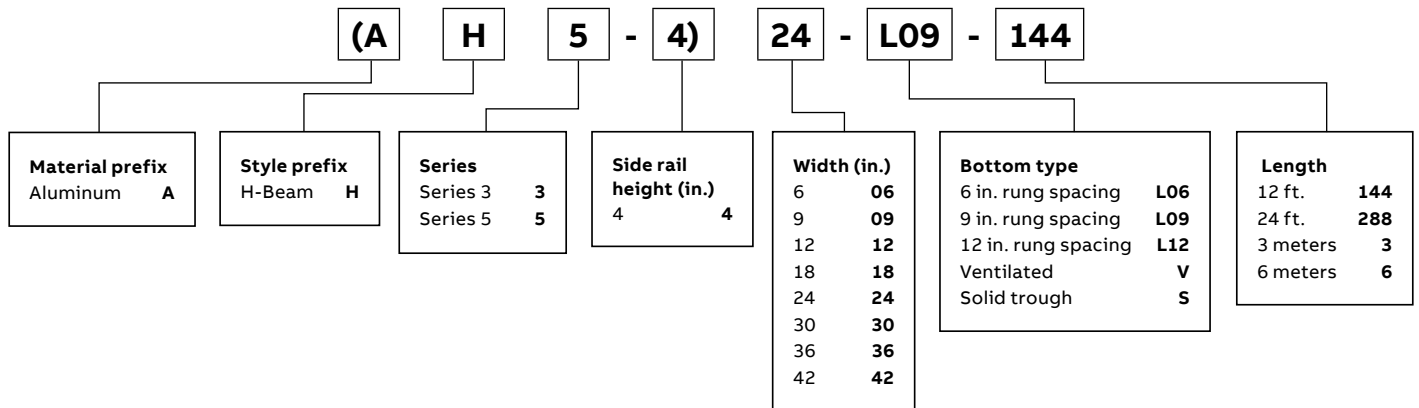

For fittings, consult pages A48 to A98.

Dimensions

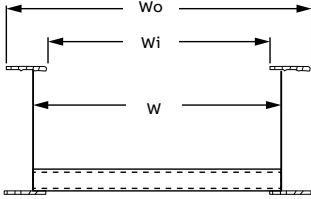
	AH3-4		AH5-4	
	W (in.)	Wo (in.)	Wi (in.)	Wo (in.)
	6	8.86	4.86	8.86
	9	11.86	7.86	11.86
	12	14.86	10.86	14.86
	18	20.86	16.86	20.86
	24	26.86	22.86	26.86
	30	32.86	28.86	32.86
	36	38.86	34.86	38.86
	42	44.86	40.86	44.86

Technical specifications

Load ratings: 1.5 safety factor. All tray sections will support an additional 200 lb concentrated load on any portion of tray (side rail, rung, etc.) above and beyond published load class.

Load ratings: 1.5 safety factor

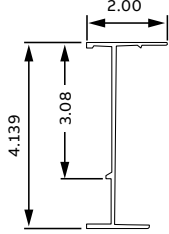
	Series	Side rail design factors 1 pair	Classifications		
			NEMA	CSA	UL
	AH3-4	Ix = 3.49 in. ⁴ Sx = 1.64 in. ³ Area = 1.28 in. ²	12C, 16B	D/6m	UL cross sectional area: 1.00 in. ²
	AH5-4	Ix = 5.33 in. ⁴ Sx = 2.36 in. ³ Area = 1.93 in. ²	20B, 16C	E/6m	UL cross sectional area: 1.50 in. ²

AH5-4

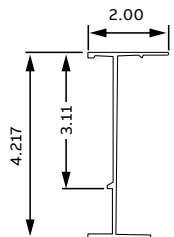

Aluminum straight lengths

5 in. Straight sections/series 2-5, 4-5 – Ladder, ventilated and solid trough



Technical specifications

All calculations and data are based on 42 in. wide cable trays with rungs spaced on 12 in. centers with tray supported as simple spans with deflection measured at the midpoint. Continuous spans may reduce deflection by as much as 50%.

Deflection factor: For lighter loads, deflection at any length can be calculated by multiplying the load by the deflection factor.

4 in. Straight sections/series 3-4, 5-4 – Ladder, ventilated and solid trough

Series		Support span (feet)							
		6	8	10	12	14	16	18	20
AH2-5	Load (lb)/ft.)	556	313	200	139	102	78	62	50
	Deflection (in.)	0.302	0.536	0.838	1.206	1.642	2.144	2.714	3.351
	Deflection factor	0.0005	0.0017	0.0042	0.0087	0.0161	0.0274	0.0440	0.0670
AH4-5	Load (lb)/ft.)	900	506	324	225	165	127	100	81
	Deflection (in.)	0.340	0.604	0.944	1.359	1.849	2.416	3.057	3.774
	Deflection factor	0.0004	0.0012	0.0029	0.0060	0.0112	0.0191	0.0306	0.0466

Straight section number selection

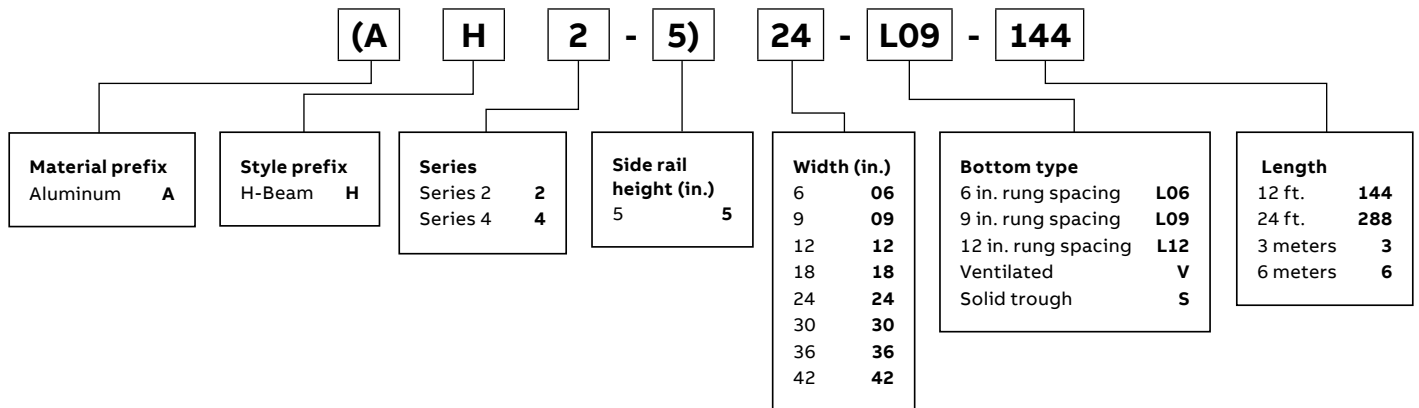

For fittings, consult pages A48 to A98.

Dimensions

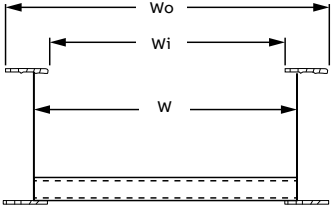
			AH2-5		AH4-5
	W (in.)	Wo (in.)	Wi (in.)	Wo (in.)	Wi (in.)
	6	8.86	4.86	8.86	4.86
	9	11.86	7.86	11.86	7.86
	12	14.86	10.86	14.86	10.86
	18	20.86	16.86	20.86	16.86
	24	26.86	22.86	26.86	22.86
	30	32.86	28.86	32.86	28.86
	36	38.86	34.86	38.86	34.86
	42	44.86	40.86	44.86	40.86

Technical specifications

Load ratings: 1.5 safety factor. All tray sections will support an additional 200 lb concentrated load on any portion of tray (side rail, rung, etc.) above and beyond published load class.

Load ratings: 1.5 safety factor

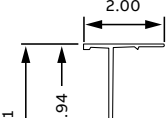
	Series	Side rail design factors 1 pair	Classifications		
			NEMA	CSA	UL
	AH2-5	$I_x = 5.37 \text{ in.}^4$ $S_x = 2.02 \text{ in.}^3$ Area = 1.39 in. ²	12C, 16A	D/6m	UL cross sectional area: 1.00 in. ²
	AH4-5	$I_x = 7.73 \text{ in.}^4$ $S_x = 2.92 \text{ in.}^3$ Area = 1.94 in. ²	20B	E/6m	UL cross sectional area: 1.50 in. ²

AH4-5

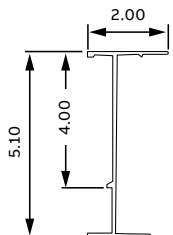

Aluminum straight lengths

6 in. Straight sections/series 1-6, 3-6 – Ladder, ventilated and solid trough



Technical specifications

All calculations and data are based on 36 in. wide cable trays with rungs spaced on 12 in. centers with tray supported as simple spans with deflection measured at the midpoint. Continuous spans may reduce deflection by as much as 50%.

Deflection factor: For lighter loads, deflection at any length can be calculated by multiplying the load by the deflection factor.

6 in. Straight sections/series 1-6, 3-6 – Ladder, ventilated and solid trough

Series		Support span (feet)							
		6	8	10	12	14	16	18	20
AH1-6	Load (lb)/ft.)	567	319	204	142	104	80	63	51
	Deflection (in.)	0.190	0.338	0.527	0.760	1.034	1.350	1.709	2.110
	Deflection factor	0.0003	0.0011	0.0026	0.0054	0.0099	0.0169	0.0271	0.0414
AH3-6	Load (lb)/ft.)	889	500	320	222	163	125	99	80
	Deflection (in.)	0.203	0.360	0.563	0.810	1.103	1.440	1.823	2.250
	Deflection factor	0.0002	0.0007	0.0018	0.0036	0.0068	0.0115	0.0185	0.0281

Straight section number selection

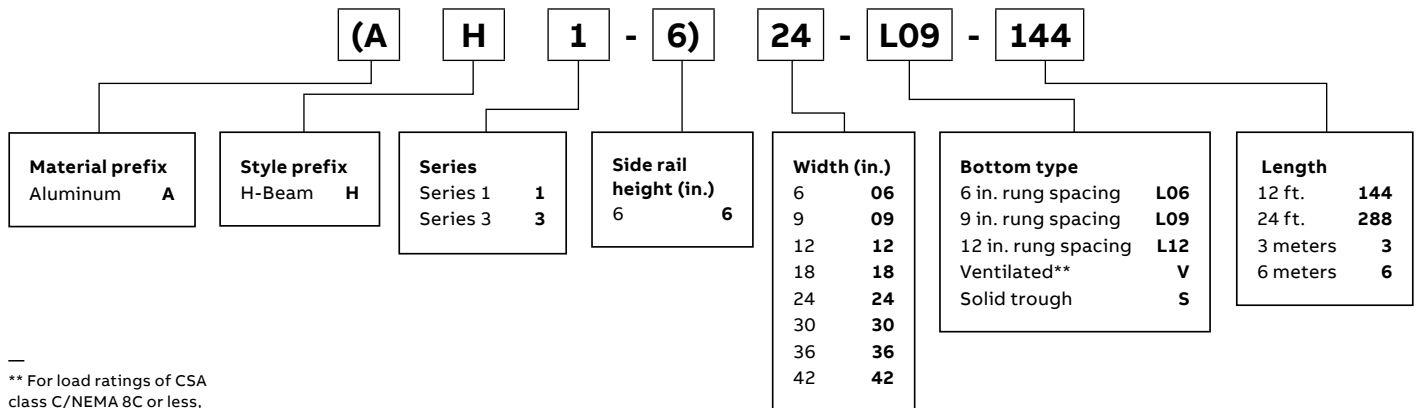

** For load ratings of CSA class C/NEMA 8C or less, please see an alternative ventilated series of cable tray called One-Piece found on pages A174 to A207 of this catalogue.

For fittings, consult pages A48 to A98.

Dimensions

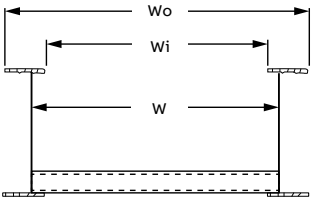
	AH1-6		AH3-6	
	W (in.)	Wo (in.)	Wi (in.)	Wo (in.)
	6	8.86	4.86	8.86
	9	11.86	7.86	11.86
	12	14.86	10.86	14.86
	18	20.86	16.86	20.86
	24	26.86	22.86	26.86
	30	32.86	28.86	32.86
	36	38.86	34.86	38.86
	42	44.86	40.86	44.86

Technical specifications

Load ratings: 1.5 safety factor. All tray sections will support an additional 200 lb concentrated load on any portion of tray (side rail, rung, etc.) above and beyond published load class.

Load ratings: 1.5 safety factor

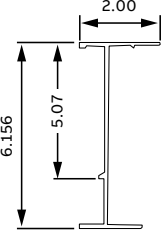
	Series	Side rail design factors 1 pair	Classifications		
			NEMA	CSA	UL
	AH1-6	$I_x = 8.7 \text{ in.}^4$ $S_x = 2.71 \text{ in.}^3$ Area = 1.55 in. ²	12C, 16A	D/6m	UL cross sectional area: 1.00 in. ²
	AH3-6	$I_x = 12.8 \text{ in.}^4$ $S_x = 3.77 \text{ in.}^3$ Area = 2.07 in. ²	20B	E/6m	UL cross sectional area: 2.00 in. ²

AH3-6

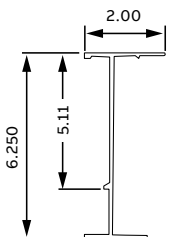

Aluminum straight lengths

6 in. Straight sections/series 4-6, 5-6, 6-6, 7-6 – Ladder, ventilated and solid trough



Technical specifications

All calculations and data are based on 42 in. wide cable trays with rungs spaced on 12 in. centers with tray supported as simple spans with deflection measured at the midpoint. Continuous spans may reduce deflection by as much as 50%.

Deflection factor: For lighter loads, deflection at any length can be calculated by multiplying the load by the deflection factor.

6 in. Straight sections/series 1-6, 3-6 – Ladder, ventilated and solid trough

Series		Support span (feet)												
		6	8	10	12	14	16	18	20	22	24	26	28	30
AH4-6	Load (lb)/ft.)	1111	625	400	278	204	156	123	100	-	-	-	-	-
	Deflection (in.)	0.235	0.418	0.653	0.940	1.280	1.672	2.115	2.612	-	-	-	-	-
	Deflection factor	0.0002	0.0007	0.0016	0.0034	0.0063	0.0107	0.0171	0.0261	-	-	-	-	-
AH5-6	Load (lb)/ft.)	-	750	480	333	245	188	148	120	-	-	-	-	-
	Deflection (in.)	-	0.441	0.690	0.993	1.352	1.766	2.234	2.759	-	-	-	-	-
	Deflection factor	-	0.0006	0.0014	0.0030	0.0055	0.0094	0.0151	0.0230	-	-	-	-	-
AH6-6	Load (lb)/ft.)	-	1031	660	458	337	258	204	165	126	106	91	78	68
	Deflection (in.)	-	0.504	0.788	1.134	1.544	2.016	2.552	3.151	3.536	4.208	4.938	5.727	6.575
	Deflection factor	-	0.0005	0.0012	0.0025	0.0046	0.0078	0.0125	0.0191	0.0280	0.0396	0.0545	0.0734	0.0967
AH7-6	Load (lb)/ft.)	-	1153	738	513	377	288	228	185	152	128	109	94	82
	Deflection (in.)	-	0.484	0.756	1.089	1.482	1.936	2.451	3.025	3.661	4.537	5.113	5.930	6.807
	Deflection factor	-	0.0004	0.0010	0.0021	0.0039	0.0067	0.0108	0.0164	0.0240	0.0340	0.0468	0.0630	0.0830

Straight section number selection

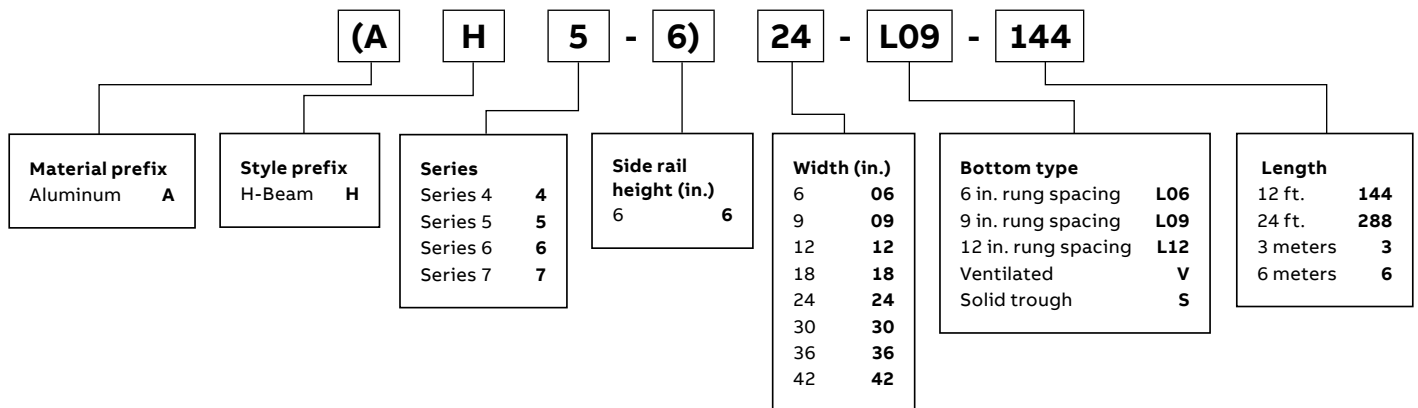

For fittings, consult pages A48 to A98.

Dimensions

	AH4-6		AH5-6	
	W (in.)	Wo (in.)	Wi (in.)	Wo (in.)
	6	8.86	4.86	8.86
	9	11.86	7.86	11.86
	12	14.86	10.86	14.86
	18	20.86	16.86	20.86
	24	26.86	22.86	26.86
	30	32.86	28.86	32.86
	36	38.86	34.86	38.86
	42	44.86	40.86	44.86

	AH6-6		AH7-6	
	W (in.)	Wo (in.)	Wi (in.)	Wo (in.)
	6	8.86	4.86	8.86
	9	11.86	7.86	11.86
	12	14.86	10.86	14.86
	18	20.86	16.86	20.86
	24	26.86	22.86	26.86
	30	32.86	28.86	32.86
	36	38.86	34.86	38.86
	42	44.86	40.86	44.86

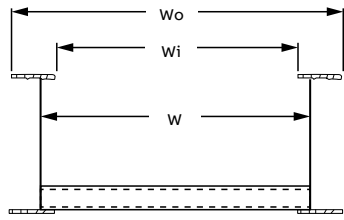

Technical specifications

Load ratings: 1.5 safety factor. All tray sections will support an additional 200 lb concentrated load on any portion of tray (side rail, rung, etc.) above and beyond published load class.

Load ratings: 1.5 safety factor

Series	Side rail design factors 1 pair	Classifications		
		NEMA	CSA	UL
AH4-6	$I_x = 13.78 \text{ in.}^4$ $S_x = 4.05 \text{ in.}^3$ Area = 2.32 in.^2	20C	Exceeds E/6m	UL cross sectional area: 2.00 in.^2
AH5-6	$I_x = 15.66 \text{ in.}^4$ $S_x = 4.64 \text{ in.}^3$ Area = 2.67 in.^2	Exceeds 20C	Exceeds E/6m	UL cross sectional area: 2.00 in.^2
AH6-6	$I_x = 18.85 \text{ in.}^4$ $S_x = 5.53 \text{ in.}^3$ Area = 3.26 in.^2	Exceeds 20C	Exceeds E/6m	UL cross sectional area: 2.00 in.^2
AH7-6	$I_x = 21.95 \text{ in.}^4$ $S_x = 6.32 \text{ in.}^3$ Area = 3.82 in.^2	Exceeds 20C	Exceeds E/6m	UL cross sectional area: 2.00 in.^2

Series	Dimensions
AH4-6	6.258 (height), 5.12 (flange height), 2.00 (flange width)
AH5-6	6.280 (height), 5.14 (flange height), 2.00 (flange width)
AH6-6	6.328 (height), 5.13 (flange height), 2.00 (flange width)
AH7-6	6.395 (height), 5.175 (flange height), 2.00 (flange width)

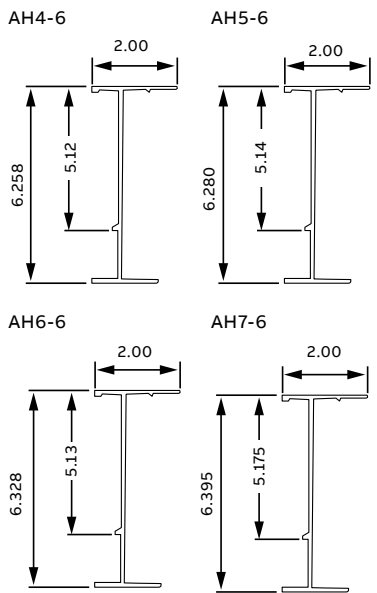

Aluminum straight lengths

7 in. and 8 in. Straight sections/series 3-7, 4-7, 1-8 – Ladder, ventilated and solid trough



Technical specifications

All calculations and data for AH3-7 and AH4-7 series are based on 42" wide cable tray with rungs spaced on 12" centers with tray supported as simple spans with deflection measured at the midpoint.

All calculations and data for AH1-8 series are based on cable tray with rungs spaced on 12" centers with tray supported as simple spans with deflection measured at the midpoint.

Continuous spans may reduce deflection by as much as 50%.

Deflection factor: For lighter loads, deflection at any length can be calculated by multiplying the load by the deflection factor.

7 in. Straight sections/series 3-7, 4-7, ventilated and solid trough

Series		Support span (feet)												
		6	8	10	12	14	16	18	20	22	24	26	28	30
AH3-7	Load (lb)/ft.)	-	925	592	411	302	231	183	148	97	81	-	-	-
	Deflection (in.)	-	0.335	0.524	0.755	1.027	1.342	1.698	2.097	2.009	2.391	-	-	-
	Deflection factor	-	0.0004	0.0009	0.0018	0.0034	0.0058	0.0093	0.0142	0.0208	0.0294	-	-	-
AH4-7	Load (lb)/ft.)	-	-	909	631	464	355	281	227	188	158	134	116	101
	Deflection (in.)	-	-	0.556	0.800	1.089	1.422	1.800	2.222	2.689	3.200	3.756	4.356	5.000
	Deflection factor	-	-	0.0006	0.0013	0.0023	0.0040	0.0064	0.0098	0.0143	0.0203	0.0279	0.0376	0.0495

8 in. Straight sections/series 1-8 – Ladder trough

Series		Support span (ft.)											
		18	20	22	24	26	28	30	32	34	36	38	40
AH1-8	Load (lb)/ft.)	528	428	353	297	253	218	190	167	148	132	118	112
	Deflection (in.)	2.136	2.637	3.191	3.797	4.457	5.169	5.933	6.751	7.625	8.548	9.486	11.054
	Deflection factor	0.004	0.0062	0.009	0.0128	0.0176	0.0237	0.0312	0.0404	0.0515	0.0648	0.0804	0.0987

For detailed width load testing, please refer to <http://tnb.ca/en/pdf-catalogues/cable-tray-systems/technical-bulletin/>.

Straight section number selection

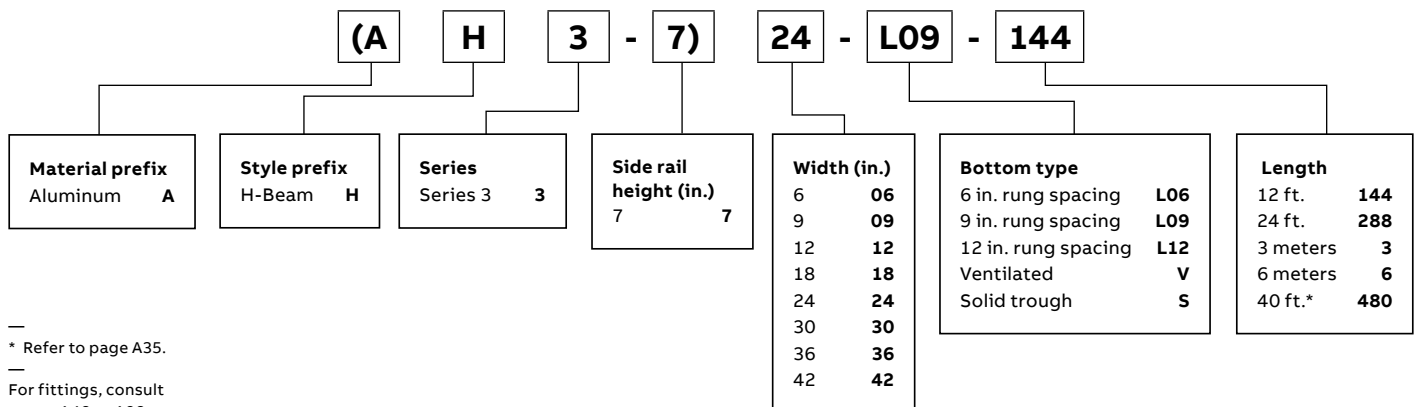

* Refer to page A35.

For fittings, consult pages A48 to A98.

Dimensions

	AH3-7		AH4-7		AH1-8	
	W (in.)	Wo (in.)	Wi (in.)	Wo (in.)	Wi (in.)	Wo (in.)
	6	8.86	4.86	8.86	4.86	7.82
	9	11.86	7.86	11.86	7.86	10.82
	12	14.86	10.86	14.86	10.86	13.82
	18	20.86	16.86	20.86	16.86	19.82
	24	26.86	22.86	26.86	22.86	25.82
	30	32.86	28.86	32.86	28.86	31.82
	36	38.86	34.86	38.86	34.86	37.82
	42	44.86	40.86	44.86	40.86	43.82

Technical specifications

Load ratings: 1.5 safety factor. All tray sections will support an additional 200 lb concentrated load on any portion of tray (side rail, rung, etc.) above and beyond published load class.

Load ratings: 1.5 safety factor

	Series	Side rail design factors 1 pair	Classifications		
			NEMA	CSA	UL
	AH3-7	$I_x = 25.41 \text{ in.}^4$ $S_x = 6.46 \text{ in.}^3$ Area = 3.29 in.^2	Exceeds 20C	Exceeds E/6m	UL cross sectional area: 2.00 in. ²
	AH4-7	$I_x = 36.81 \text{ in.}^4$ $S_x = 9.08 \text{ in.}^3$ Area = 4.63 in.^2	Exceeds 20C	Exceeds E/6m	UL cross sectional area: 2.00 in. ²
	AH1-8	$I_x = 58.36 \text{ in.}^4$ $S_x = 13.37 \text{ in.}^3$ Area = 5.86 in.^2	Exceeds 20C	Exceeds E/6m	UL cross sectional area: 2.00 in. ²

Aluminum cable tray

Fittings – Explaining the fitting styles

U-style

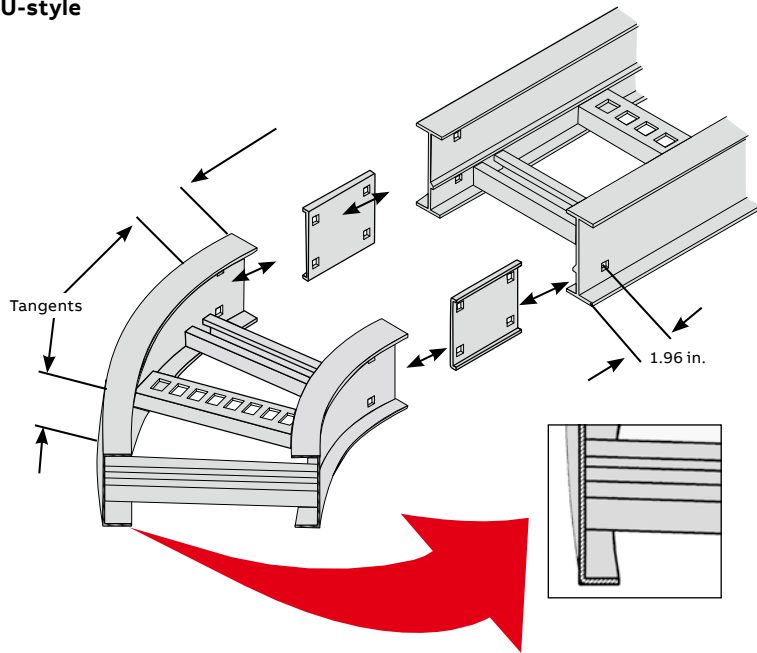

U-style

U-style fittings constructed with side rail flanges on the inside only (U-beam)*

Features and benefits

- U-style and H-style are interchangeable
- Lowest purchase price
- Easy to install
- Occupies less space in areas where space is restrained
- Easy-to-align straights
- Splice plate holds components together while hardware is inserted
- Lighter fittings are easy to handle
- Functional design
- Tangents on fittings
- 7 in. length snap-in splice plate

H-style

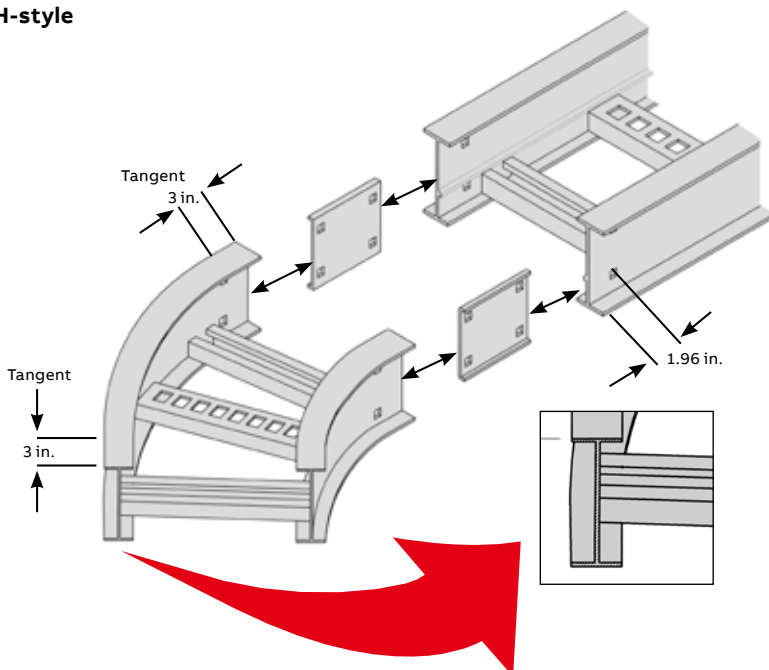

H-style

H-style fittings constructed with side rail having inner and outer flanges (H-beam).*

Features and benefits

- Improved system rigidity
- Improved aesthetics and customer appeal
- Easy to install
- Easy to align straights and fittings
- Splice plate holds components together while hardware is inserted
- Premium design
- 3 in. tangents on fittings
- 7 in. length snap-in splice plate

* T&B aluminum cable tray is composed of two distinct systems, H-style and U-style. These systems are interchangeable.

Horizontal fittings selection

— The U-style and H-style systems are interchangeable.

Fittings in a cable tray system are required to change cable routing direction and to join straight sections and other fittings. This step of the cable tray selection process requires that the specifier chooses between two distinct styles, U and H.

H-style fitting

- An H-shaped extrusion forms the fitting side rail.
- H-style fittings utilize a 7 in. splice plate and have 3 in. tangents at the extremities.
- This style offers enhanced aesthetics to the end-user and increased system rigidity.

U-style fitting

- A U-shaped extrusion forms the fitting side rail.
- U-style fittings utilize a 7 in. splice plate and have tangents at the extremities.
- This style offers maximum quality versus cost ratios of the installation.

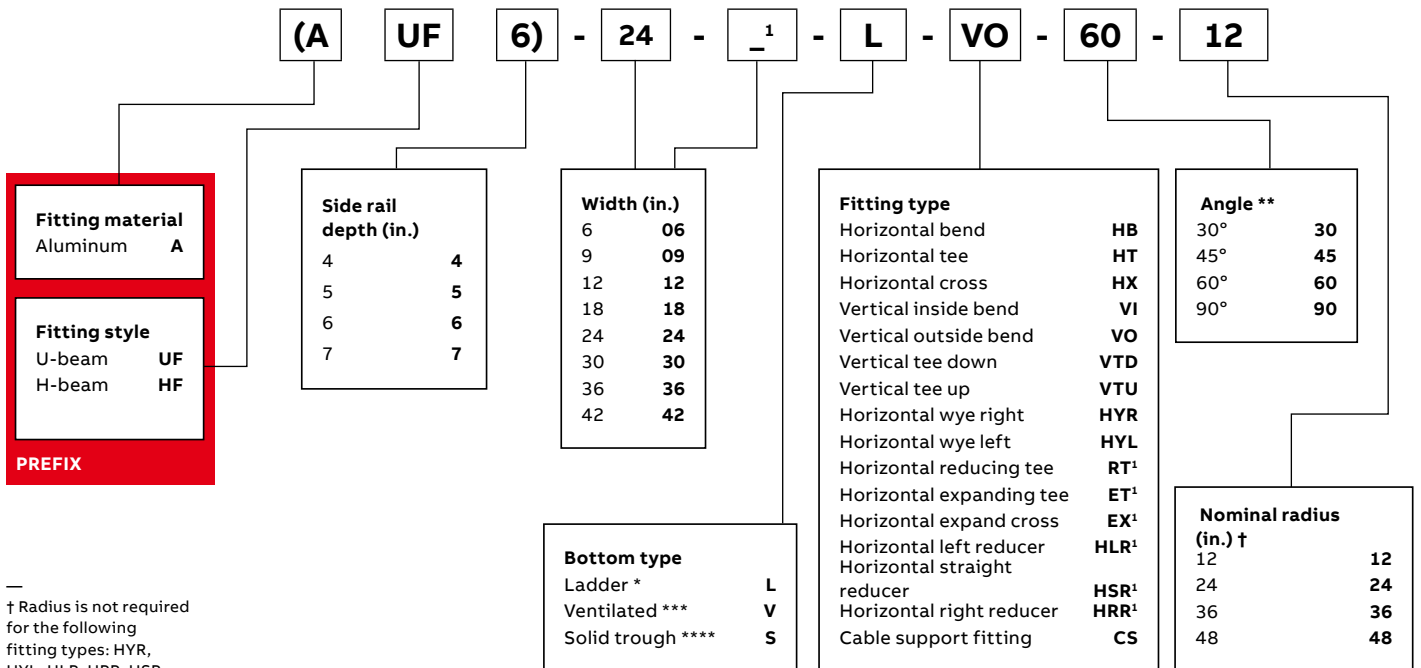

† Radius is not required for the following fitting types: HYR, HYL, HLR, HRR, HSR

* Manufactured with 9 in. rung spacing measured at the center line of fitting.

** Angle is required for HB, VI, VO only.

*** Manufactured with 4 in. edge-to-edge rung spacing measured at the center line of fitting.

**** Manufactured with flat sheet inserted under rungs with 9 in. rung spacing measured at the center line of fitting.

¹ A second width is required.

Aluminum horizontal fittings

U- and H-style horizontal fittings selection guide – Bends

-
- 01 **U-style**
90° Horizontal bend
Page A60—
- 02 **U-style**
60° Horizontal bend
Page A61
-
- 03 **U-style**
45° Horizontal bend
Page A64—
- 04 **U-style**
30° Horizontal bend
Page A65
-
- 05 **H-style**
90° Horizontal bend
Page A62
-
- 06 **H-style**
60° Horizontal bend
Page A63
-
- 07 **H-style**
45° Horizontal bend
Page A66
-
- 08 **H-style**
30° Horizontal bend
Page A67
-
- T&B aluminum cable tray is composed of two distinct systems, H-style and U-style. These systems are interchangeable.



01



05



02



06



03



07



04



08

H = H-style

U = U-style

Aluminum horizontal fittings

U- and H-style horizontal fittings selection guide – Tees and crosses

01 **U-style**
Tee
Page A68

02 **U-style**
Cross
Page A69

03 **U-style**
Horizontal reducing tee
Page A72

04 **H-style**
Tee
Page A70

05 **H-style**
Cross
Page A71

06 **H-style**
Horizontal reducing tee
Page A713

T&B aluminum cable tray is composed of two distinct systems, H-style and U-style. These systems are interchangeable.



01

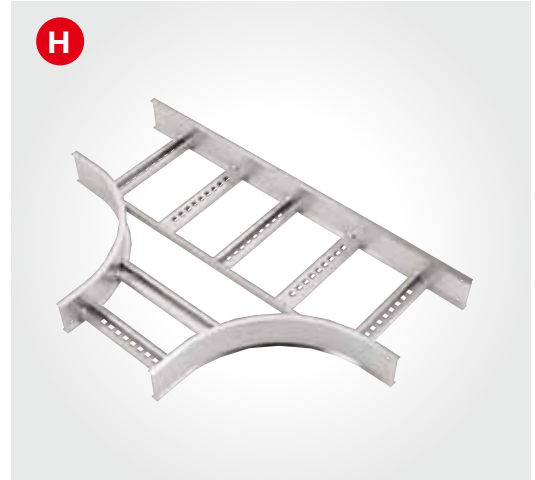

04

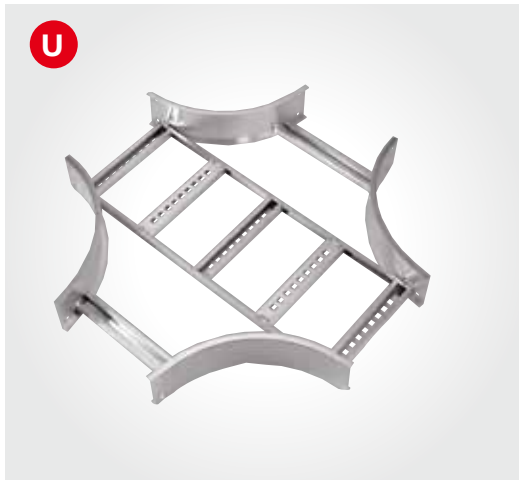

02

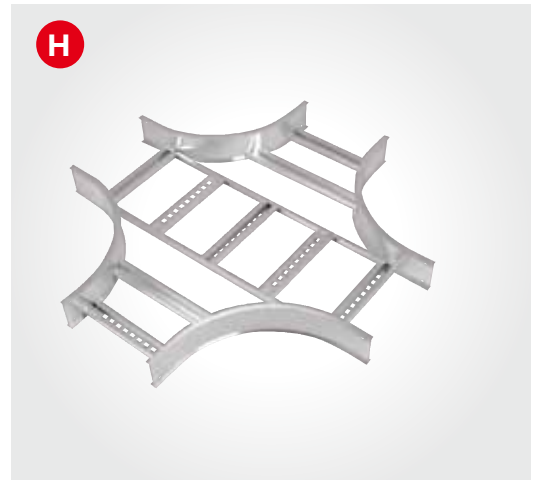

05

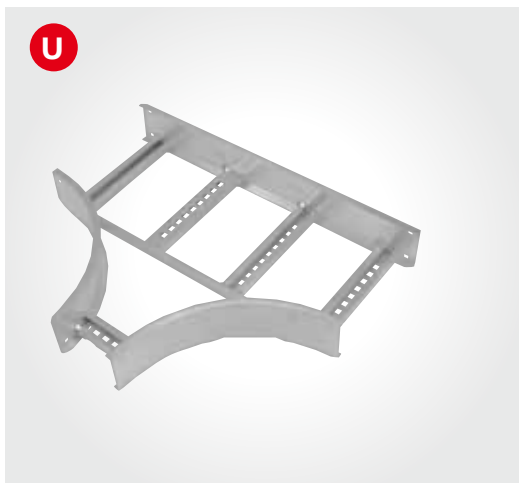

03



06

H = H-style

U = U-style

Aluminum horizontal fittings

U- and H-style horizontal fittings selection guide – Tees and crosses (continued)

—
01 **U-style**
Horizontal
expanding tee
Page A74

—
02 **U-style**
Horizontal
expanding cross
Page A76

—
03 **H-style**
Horizontal
expanding tee
Page A75

—
04 **H-style**
Horizontal
expanding cross
Page A77

—
T&B aluminum cable
tray is composed of
two distinct systems,
H-style and U-style.
These systems are
interchangeable.



01

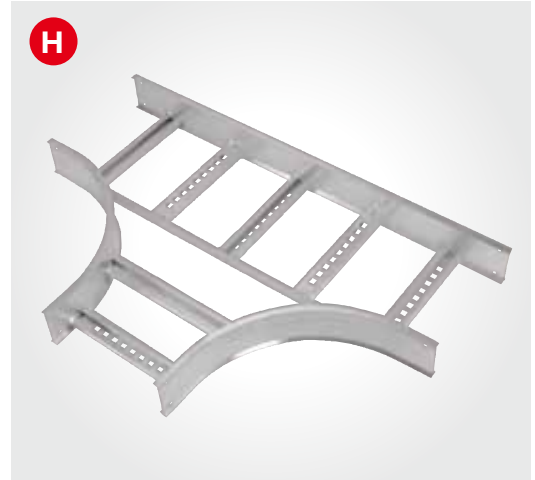

03

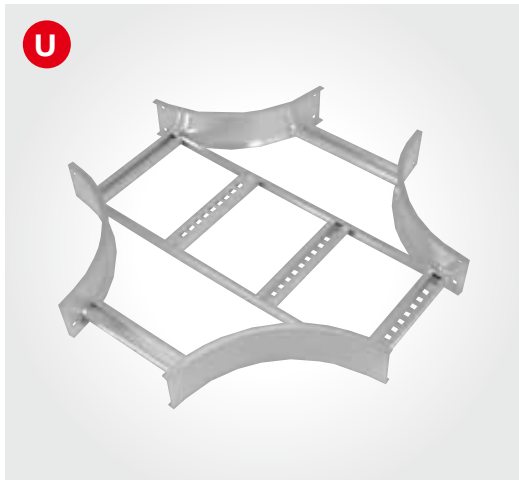

02

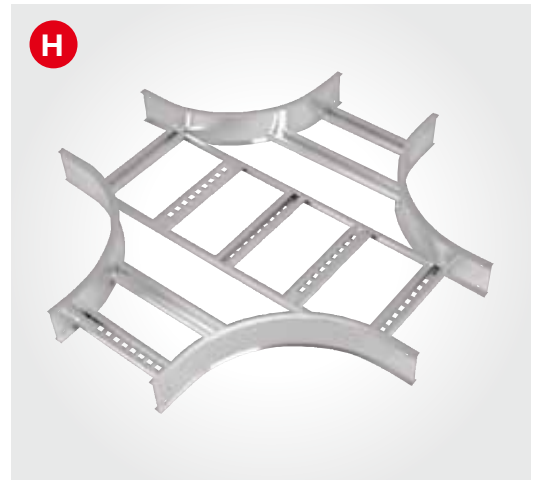

04

H = H-style

U = U-style

Aluminum vertical fittings

U- and H-style vertical fittings selection guide – Reducers and wyes

01 **U-style**
Offset reducer right
Page A78



01

02

02 **U-style**
Reducer straight
Page A78



03

03 **U-style**
Offset reducer left
Page A78

04 **H-style**
Offset reducer right
Page A80



04

05

05 **H-style**
Reducer straight
Page A80



06

06 **H-style**
Offset reducer left
Page A80

07 **U-style**
Left-hand wye
Page A82



07

08

08 **U-style**
Right-hand wye
Page A82



09 **H-style**
Left-hand wye
Page A83



09

10

10 **H-style**
Right-hand wye
Page A83



T&B aluminum cable tray is composed of two distinct systems, H-style and U-style. These systems are interchangeable.

H = H-style

U = U-style

Aluminum vertical fittings

U- and H-style vertical fittings selection guide – Bends

01 **U-style**
90° Outside bend
Page A84



01

02 **U-style**
90° Inside bend
Page A84



05

03 **U-style**
60° Outside bend
Page A86



02

04 **U-style**
60° Inside bend
Page A86



06

05 **H-style**
90° Outside bend
Page A85

06 **H-style**
90° Inside bend
Page A85

07 **H-style**
60° Outside bend
Page A87

08 **H-style**
60° Inside bend
Page A87

T&B aluminum cable tray is composed of two distinct systems, H-style and U-style. These systems are interchangeable.



03



07

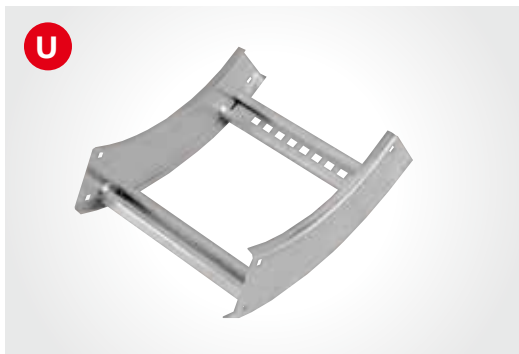

04



08

H = H-style

U = U-style

—
09 U-style
 45° Outside bend
 Page A88
 —

10 U-style
 45° Inside bend
 Page A88
 —

11 U-style
 30° Outside bend
 Page A90
 —

12 U-style
 30° Inside bend
 Page A90
 —

13 H-style
 45° Outside bend
 Page A89
 —

14 H-style
 45° Inside bend
 Page A89
 —

15 H-style
 30° Outside bend
 Page A91
 —

16 H-style
 30° Inside bend
 Page A91
 —

T&B aluminum cable tray is composed of two distinct systems, H-style and U-style. These systems are interchangeable.



09



13



10



14



11



15



12



16

H = H-style

U = U-style

Aluminum vertical fittings

U- and H-style vertical fittings selection guide – Tees up/down

01 **U-style**
Vertical tee up
Page A92

02 **U-style**
Vertical tee down
Page A92

03 **H-style**
Vertical tee up
Page A93

04 **H-style**
Vertical tee down
Page A93

T&B aluminum cable tray is composed of two distinct systems, H-style and U-style. These systems are interchangeable.



01

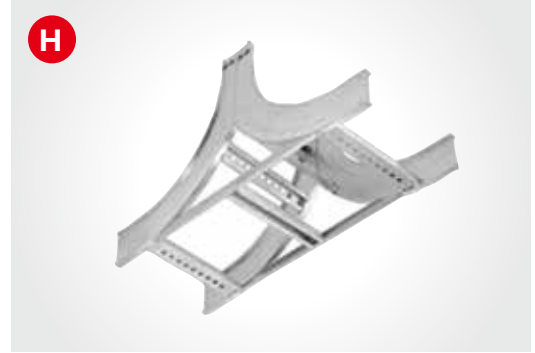

05

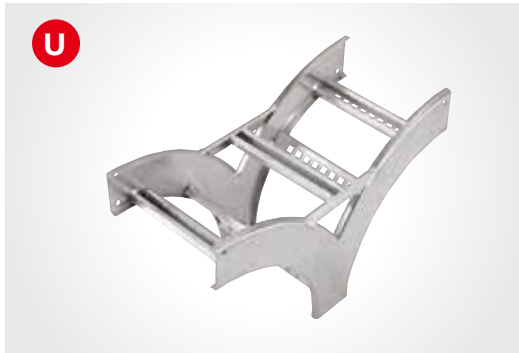

02



06

H = H-style

U = U-style

Aluminum vertical fittings

U- and H-style vertical fittings selection guide – Cable supports

—
01 **U-style**
Cable support
Page A94
—

02 **H-style**
Cable support
Page A95
—

T&B aluminum cable tray is composed of two distinct systems, H-style and U-style. These systems are interchangeable.

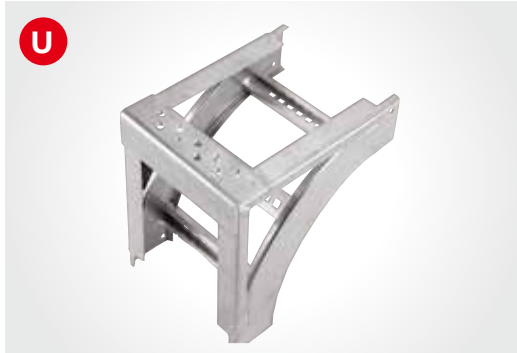

01



02

H = H-style

U = U-style

Aluminum fittings

Flexible coupler

Exterior strap provides accurate radius to meet your cable tray design requirements.

The flexible coupler provides easy installation without measuring and cutting cable tray side rails. Once installed, the coupler allows for electrical continuity, therefore eliminating the requirement for a bonding jumper.

- Formed ribs provide better cable protection
- Fast and easy installation
- Meets the electrical continuity requirement of NEMA VE1 and CSA C22.2 No. 126.1

Features and benefits

- Reduces installation time
- No need for a bonding jumper
- Flexible and economical alternative to regular AU/AH fitting

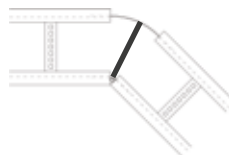
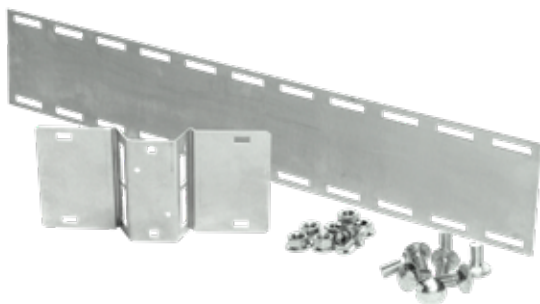
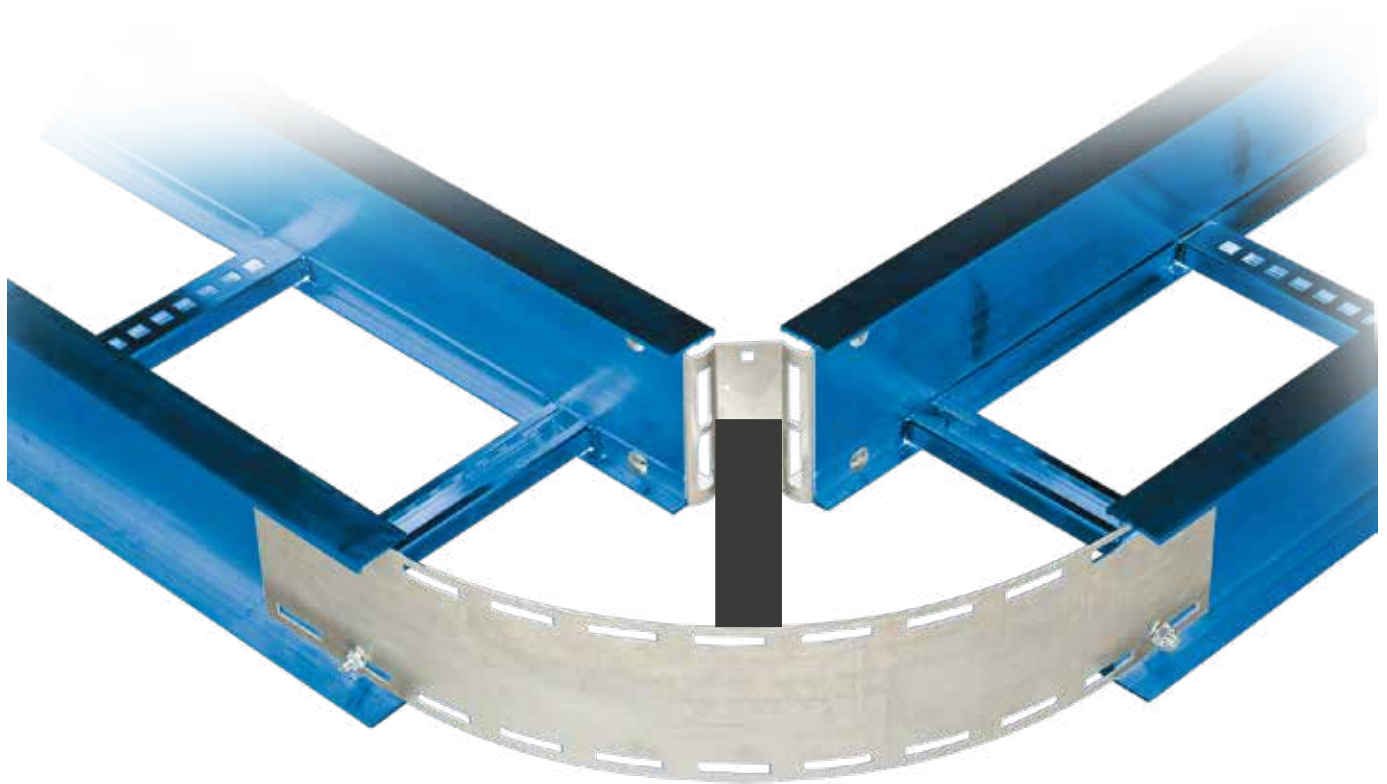

Aluminum fittings

Aluminum – Flexible coupler



Aluminum – Flexible coupler



Cat. no.	Material	Side rail height (in.)	Tray width (in.)
ABW-(*)06HBP	Aluminum	4 to 7	06
ABW-(*)09HBP	Aluminum	4 to 7	09
ABW-(*)12HBP	Aluminum	4 to 7	12
ABW-(*)18HBP	Aluminum	4 to 7	18
ABW-(*)24HBP	Aluminum	4 to 7	24
ABW-(*)30HBP	Aluminum	4 to 7	30
ABW-(*)36HBP	Aluminum	4 to 7	36

*Insert side rail height

Optional rung information (provides additional cable support)

Cat. no.	Material	Tray width (in.)
ABW-R(*)HBP	Aluminum	06
	Aluminum	09
	Aluminum	12
	Aluminum	18
	Aluminum	24
	Aluminum	30
	Aluminum	36

* Insert tray width

Load rating with optional rung

Tray width	Side rail height		
	3 in. (76 mm)	4 and 5 in. (102 and 127 mm)	6 and 7 in. (152 and 178 mm)
36 in. (914 mm)	50 lb/ft. (74 kg/m)	Al: 75 lb/ft. (112 kg/m) Steel: 50 lb/ft. (74 kg/m)	100 lb/ft. (149 kg/m)
30 in. (762 mm)	75 lb/ft. (112 kg/m)	100 lb/ft. (149 kg/m)	100 lb/ft. (149 kg/m)
6 to 24 in. (152 to 610 mm)	100 lb/ft. (149 kg/m)	100 lb/ft. (149 kg/m)	100 lb/ft. (149 kg/m)

- 01 Fasten flexible coupler to tray.
- 02 Bend.
- 03 Fasten to the other length of cable tray.
- 04 Fasten the strap.

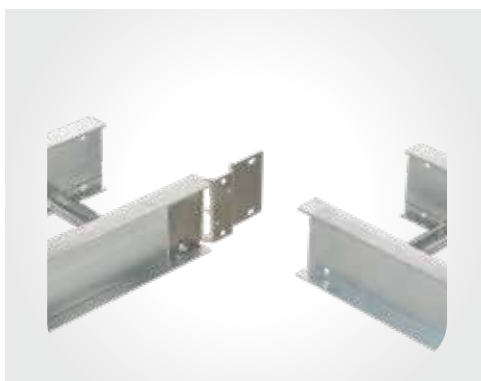

01



02



03

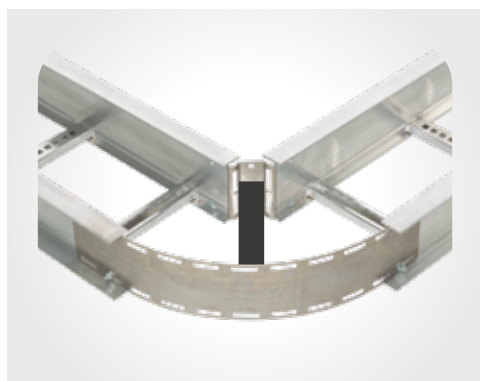

04

Aluminum fittings

90°/60° U-style horizontal bend fittings

90° Horizontal bend – U-style

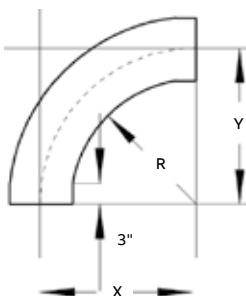
Nominal radius (in.)	Nominal width (in.)	Cat. no.	Dimensions (in.)	
			X	Y
12	6	AUF(t)-06-(*)-HB90-12	15	15
12	9	AUF(t)-09-(*)-HB90-12	16½	16½
12	12	AUF(t)-12-(*)-HB90-12	18	18
12	18	AUF(t)-18-(*)-HB90-12	21	21
12	24	AUF(t)-24-(*)-HB90-12	24	24
12	30	AUF(t)-30-(*)-HB90-12	27	27
12	36	AUF(t)-36-(*)-HB90-12	30	30
12	42	AUF(t)-42-(*)-HB90-12	33	33
24	6	AUF(t)-06-(*)-HB90-24	27	27
24	9	AUF(t)-09-(*)-HB90-24	28½	28½
24	12	AUF(t)-12-(*)-HB90-24	30	30
24	18	AUF(t)-18-(*)-HB90-24	33	33
24	24	AUF(t)-24-(*)-HB90-24	36	36
24	30	AUF(t)-30-(*)-HB90-24	39	39
24	36	AUF(t)-36-(*)-HB90-24	42	42
24	42	AUF(t)-42-(*)-HB90-24	45	45
36	6	AUF(t)-06-(*)-HB90-36	39	39
36	9	AUF(t)-09-(*)-HB90-36	40½	40½
36	12	AUF(t)-12-(*)-HB90-36	42	42
36	18	AUF(t)-18-(*)-HB90-36	45	45
36	24	AUF(t)-24-(*)-HB90-36	48	48
36	30	AUF(t)-30-(*)-HB90-36	51	51
36	36	AUF(t)-36-(*)-HB90-36	54	54
36	42	AUF(t)-42-(*)-HB90-36	57	57
48	6	AUF(t)-06-(*)-HB90-48	51	51
48	9	AUF(t)-09-(*)-HB90-48	52½	52½
48	12	AUF(t)-12-(*)-HB90-48	54	54
48	18	AUF(t)-18-(*)-HB90-48	57	57
48	24	AUF(t)-24-(*)-HB90-48	60	60
48	30	AUF(t)-30-(*)-HB90-48	63	63
48	36	AUF(t)-36-(*)-HB90-48	66	66
48	42	AUF(t)-42-(*)-HB90-48	69	69

(t) Insert side rail height. (*) Insert bottom style to complete cat. no. Includes 1 pair of splice plates with hardware.
 T&B aluminum cable tray is composed of two distinct systems, H-style and U-style. These systems are interchangeable.

Part numbering system

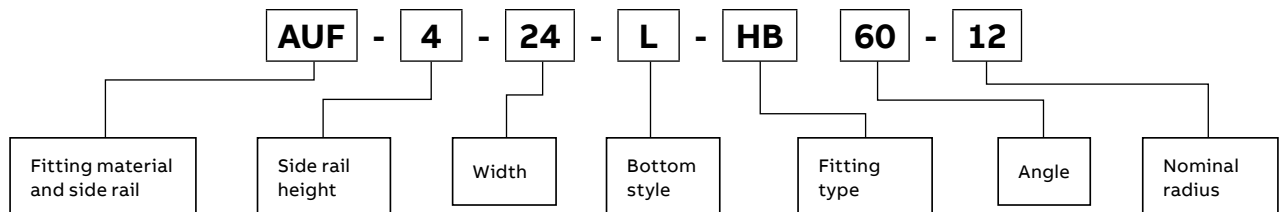

60° Horizontal bend – U-style

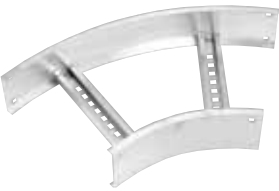
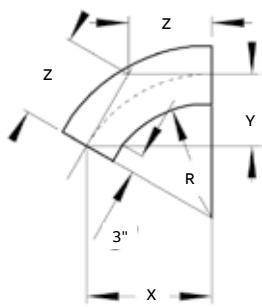
	Nominal radius (in.)	Nominal width (in.)	Cat. no.	Dimensions (in.)		
				X	Y	Z
	12	6	AUF(t)-06-(*)-HB60-12	14 ⁷ / ₁₆	8 ⁵ / ₁₆	9 ¹⁵ / ₁₆
	12	9	AUF(t)-09-(*)-HB60-12	16 ³ / ₁₆	9 ⁵ / ₁₆	10 ¹³ / ₁₆
	12	12	AUF(t)-12-(*)-HB60-12	17 ¹ / ₂	10 ⁵ / ₁₆	11 ¹¹ / ₁₆
	12	18	AUF(t)-18-(*)-HB60-12	20 ¹ / ₁₆	11 ⁵ / ₁₆	13 ³ / ₁₆
	12	24	AUF(t)-24-(*)-HB60-12	22 ¹¹ / ₁₆	13 ³ / ₁₆	15 ¹ / ₁₆
	12	30	AUF(t)-30-(*)-HB60-12	25 ⁵ / ₁₆	14 ⁵ / ₁₆	16 ⁷ / ₁₆
	12	36	AUF(t)-36-(*)-HB60-12	27 ⁷ / ₁₆	16 ¹ / ₁₆	18 ⁹ / ₁₆
	12	42	AUF(t)-42-(*)-HB60-12	30 ¹ / ₂	17 ⁵ / ₁₆	20 ⁵ / ₁₆
	24	6	AUF(t)-06-(*)-HB60-24	25 ⁵ / ₁₆	14 ⁵ / ₁₆	16 ⁷ / ₁₆
	24	9	AUF(t)-09-(*)-HB60-24	26 ⁹ / ₁₆	15 ³ / ₁₆	17 ³ / ₄
	24	12	AUF(t)-12-(*)-HB60-24	27 ⁷ / ₁₆	16 ¹ / ₁₆	18 ⁹ / ₁₆
	24	18	AUF(t)-18-(*)-HB60-24	30 ¹ / ₂	17 ³ / ₁₆	20 ⁵ / ₁₆
	24	24	AUF(t)-24-(*)-HB60-24	33 ¹ / ₁₆	19 ¹ / ₁₆	22 ¹ / ₁₆
	24	30	AUF(t)-30-(*)-HB60-24	35 ¹¹ / ₁₆	20 ⁵ / ₁₆	23 ¹³ / ₁₆
	24	36	AUF(t)-36-(*)-HB60-24	38 ¹ / ₄	22 ¹ / ₁₆	25 ¹ / ₂
	24	42	AUF(t)-42-(*)-HB60-24	40 ⁷ / ₁₆	23 ³ / ₁₆	27 ¹ / ₄
	36	6	AUF(t)-06-(*)-HB60-36	35 ¹¹ / ₁₆	20 ⁵ / ₁₆	23 ¹³ / ₁₆
	36	9	AUF(t)-09-(*)-HB60-36	37	21 ³ / ₁₆	24 ⁵ / ₁₆
	36	12	AUF(t)-12-(*)-HB60-36	38 ¹ / ₄	22 ¹ / ₁₆	25 ¹ / ₂
	36	18	AUF(t)-18-(*)-HB60-36	40 ⁷ / ₁₆	23 ³ / ₁₆	27 ³ / ₁₆
	36	24	AUF(t)-24-(*)-HB60-36	43 ¹ / ₂	25 ¹ / ₁₆	29
	36	30	AUF(t)-30-(*)-HB60-36	46 ¹ / ₁₆	26 ⁵ / ₁₆	30 ¹¹ / ₁₆
	36	36	AUF(t)-36-(*)-HB60-36	48 ¹ / ₁₆	28 ¹ / ₁₆	32 ⁷ / ₁₆
	36	42	AUF(t)-42-(*)-HB60-36	51 ¹ / ₄	29 ³ / ₁₆	34 ³ / ₁₆
	48	6	AUF(t)-06-(*)-HB60-48	46 ¹ / ₁₆	26 ⁵ / ₁₆	30 ¹¹ / ₁₆
	48	9	AUF(t)-09-(*)-HB60-48	47 ³ / ₁₆	27 ³ / ₁₆	31 ¹ / ₁₆
48	12	AUF(t)-12-(*)-HB60-48	48 ¹¹ / ₁₆	28 ¹ / ₁₆	32 ⁷ / ₁₆	
48	18	AUF(t)-18-(*)-HB60-48	51 ¹ / ₁₆	29 ³ / ₁₆	34 ³ / ₁₆	
48	24	AUF(t)-24-(*)-HB60-48	53 ³ / ₁₆	31 ¹ / ₁₆	35 ¹⁵ / ₁₆	
48	30	AUF(t)-30-(*)-HB60-48	56 ⁷ / ₁₆	32 ⁵ / ₁₆	37 ³ / ₁₆	
48	36	AUF(t)-36-(*)-HB60-48	59 ¹ / ₁₆	34 ¹ / ₁₆	39 ³ / ₁₆	
48	42	AUF(t)-42-(*)-HB60-48	61 ¹¹ / ₁₆	35 ⁵ / ₁₆	41 ¹ / ₈	

(t) Insert side rail height. (*) Insert bottom style to complete cat. no. Includes 1 pair of splice plates with hardware.

T&B aluminum cable tray is composed of two distinct systems, H-style and U-style. These systems are interchangeable.

Selection guide

- Inside tray widths: 6, 9, 12, 18, 24, 30, 36, 42 in.
- Angle: 90°, 60°
- Nominal radius: 12, 24, 36, 48 in.
- Bottom styles: L– ladder, V– ventilated, S– solid
- Side rail heights: 4–7 in.

Aluminum fittings

90°/60° H-style horizontal bend fittings

90° Horizontal bend – H-style

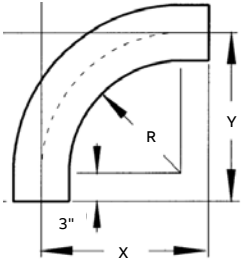
	Nominal radius (in.)	Nominal width (in.)	Cat. no.	Dimensions (in.)	
				X	Y
	12	6	AHF(t)-06-(*)-HB90-12	18	18
	12	9	AHF(t)-09-(*)-HB90-12	19½	19½
	12	12	AHF(t)-12-(*)-HB90-12	21	21
	12	18	AHF(t)-18-(*)-HB90-12	24	24
	12	24	AHF(t)-24-(*)-HB90-12	27	27
	12	30	AHF(t)-30-(*)-HB90-12	30	30
	12	36	AHF(t)-36-(*)-HB90-12	33	33
	12	42	AHF(t)-42-(*)-HB90-12	36	36
	24	6	AHF(t)-06-(*)-HB90-24	30	30
	24	9	AHF(t)-09-(*)-HB90-24	31½	31½
	24	12	AHF(t)-12-(*)-HB90-24	33	33
	24	18	AHF(t)-18-(*)-HB90-24	36	36
	24	24	AHF(t)-24-(*)-HB90-24	39	39
	24	30	AHF(t)-30-(*)-HB90-24	42	42
	24	36	AHF(t)-36-(*)-HB90-24	45	45
	24	42	AHF(t)-42-(*)-HB90-24	48	48
	36	6	AHF(t)-06-(*)-HB90-36	42	42
	36	9	AHF(t)-09-(*)-HB90-36	43½	43½
	36	12	AHF(t)-12-(*)-HB90-36	45	45
	36	18	AHF(t)-18-(*)-HB90-36	48	48
36	24	AHF(t)-24-(*)-HB90-36	51	51	
36	30	AHF(t)-30-(*)-HB90-36	54	54	
36	36	AHF(t)-36-(*)-HB90-36	57	57	
36	42	AHF(t)-42-(*)-HB90-36	60	60	
	48	6	AHF(t)-06-(*)-HB90-48	54	54
	48	9	AHF(t)-09-(*)-HB90-48	55½	55½
	48	12	AHF(t)-12-(*)-HB90-48	57	57
	48	18	AHF(t)-18-(*)-HB90-48	60	60
	48	24	AHF(t)-24-(*)-HB90-48	63	63
	48	30	AHF(t)-30-(*)-HB90-48	66	66
	48	36	AHF(t)-36-(*)-HB90-48	69	69
	48	42	AHF(t)-42-(*)-HB90-48	72	72

(t) Insert side rail height. (*) Insert bottom style to complete cat. no. Includes 1 pair of splice plates with hardware.
 T&B aluminum cable tray is composed of two distinct systems, H-style and U-style. These systems are interchangeable.

Part numbering system

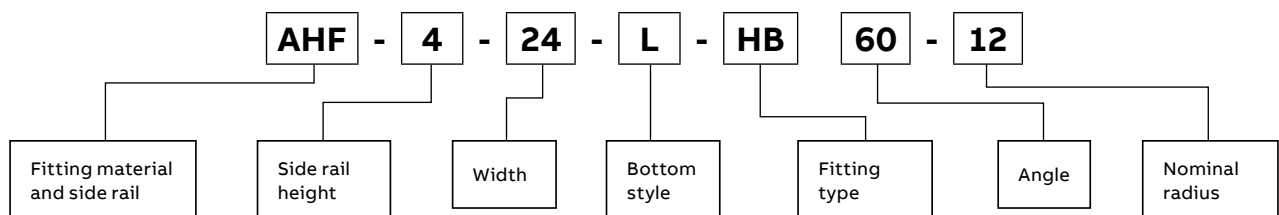

60° Horizontal bend – H-style

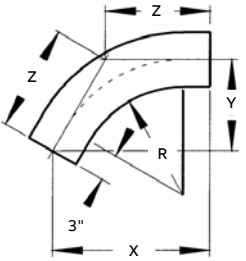
	Nominal radius (in.)	Nominal width (in.)	Cat. no.	Dimensions (in.)		
				X	Y	Z
	12	6	AHF(t)-06-(*)-HB60-12	17½	10⅞	11¼ ¹⁵ / ₁₆
	12	9	AHF(t)-09-(*)-HB60-12	18 ¹³ / ₁₆	10⅞	12½
	12	12	AHF(t)-12-(*)-HB60-12	20¼ ¹⁵ / ₁₆	11⅝	13⅜
	12	18	AHF(t)-18-(*)-HB60-12	22¼ ¹⁵ / ₁₆	13⅜	15⅝
	12	24	AHF(t)-24-(*)-HB60-12	25⅝ ¹⁵ / ₁₆	14⅝	16⅞
	12	30	AHF(t)-30-(*)-HB60-12	27⅞	16⅜	18⅞ ¹⁵ / ₁₆
	12	36	AHF(t)-36-(*)-HB60-12	30½	17⅞	20⅝ ¹⁵ / ₁₆
	12	42	AHF(t)-42-(*)-HB60-12	33¼ ¹⁵ / ₁₆	19⅜	22¼ ¹⁵ / ₁₆
	24	6	AHF(t)-06-(*)-HB60-24	27⅞	16⅜	18⅞ ¹⁵ / ₁₆
	24	9	AHF(t)-09-(*)-HB60-24	29⅞ ¹⁵ / ₁₆	16⅞	19⅞ ¹⁵ / ₁₆
	24	12	AHF(t)-12-(*)-HB60-24	30½	17⅞	20⅝ ¹⁵ / ₁₆
	24	18	AHF(t)-18-(*)-HB60-24	33¼ ¹⁵ / ₁₆	19⅜	22¼ ¹⁵ / ₁₆
	24	24	AHF(t)-24-(*)-HB60-24	35¼ ¹⁵ / ₁₆	20⅞	23 ¹³ / ₁₆
	24	30	AHF(t)-30-(*)-HB60-24	38¼	22⅞	25½
	24	36	AHF(t)-36-(*)-HB60-24	40⅞	23⅝	27¼
	24	42	AHF(t)-42-(*)-HB60-24	43⅞ ¹⁵ / ₁₆	25⅝	29⅞ ¹⁵ / ₁₆
	36	6	AHF(t)-06-(*)-HB60-36	38¼	22⅞	25½
	36	9	AHF(t)-09-(*)-HB60-36	39⅞ ¹⁵ / ₁₆	22⅞	26⅞
	36	12	AHF(t)-12-(*)-HB60-36	40⅞	23⅝	27¼
	36	18	AHF(t)-18-(*)-HB60-36	43½	25⅝	29
	36	24	AHF(t)-24-(*)-HB60-36	46¼ ¹⁵ / ₁₆	26⅞	30¼ ¹⁵ / ₁₆
	36	30	AHF(t)-30-(*)-HB60-36	48¼ ¹⁵ / ₁₆	28⅜	32⅞ ¹⁵ / ₁₆
	36	36	AHF(t)-36-(*)-HB60-36	51¼	29⅞	34⅞ ¹⁵ / ₁₆
	36	42	AHF(t)-42-(*)-HB60-36	53⅞	31⅞	35⅞ ¹⁵ / ₁₆
	48	6	AHF(t)-06-(*)-HB60-48	48¼ ¹⁵ / ₁₆	28⅜	32⅞ ¹⁵ / ₁₆
	48	9	AHF(t)-09-(*)-HB60-48	49 ¹⁵ / ₁₆	28⅞	33⅞ ¹⁵ / ₁₆
	48	12	AHF(t)-12-(*)-HB60-48	51¼	29⅞	34⅞ ¹⁵ / ₁₆
	48	18	AHF(t)-18-(*)-HB60-48	53⅞	31⅞	35 ¹⁵ / ₁₆
48	24	AHF(t)-24-(*)-HB60-48	56¼ ¹⁵ / ₁₆	32⅞	37⅞	
48	30	AHF(t)-30-(*)-HB60-48	59¼ ¹⁵ / ₁₆	34⅜	39⅞	
48	36	AHF(t)-36-(*)-HB60-48	61¼ ¹⁵ / ₁₆	35⅝	41⅞	
48	42	AHF(t)-42-(*)-HB60-48	64¼	37⅞	42 ¹³ / ₁₆	

(t) Insert side rail height. (*) Insert bottom style to complete cat. no. Includes 1 pair of splice plates with hardware.

T&B aluminum cable tray is composed of two distinct systems, H-style and U-style. These systems are interchangeable.

Selection guide

- Inside tray widths: 6, 9, 12, 18, 24, 30, 36, 42 in.
- Angle: 90°, 60°
- Nominal radius: 12, 24, 36, 48 in.
- Bottom styles: L– ladder, V– ventilated, S– solid
- Side rail heights: 4 –7 in.

Aluminum fittings

45°/30° U-style horizontal bend fittings

45° Horizontal bend – U-style



Nominal radius (in.)	Nominal width (in.)	Cat. no.	Dimensions (in.)		
			X	Y	Z
12	6	AUF(t)-06-(*)-HB45-12	13 ⁵ / ₁₆	5 ⁵ / ₁₆	8
12	9	AUF(t)-09-(*)-HB45-12	14 ¹¹ / ₁₆	6 ¹ / ₁₆	8 ⁹ / ₁₆
12	12	AUF(t)-12-(*)-HB45-12	15 ³ / ₄	6 ¹ / ₂	9 ³ / ₁₆
12	18	AUF(t)-18-(*)-HB45-12	17 ⁷ / ₈	7 ³ / ₈	10 ⁷ / ₁₆
12	24	AUF(t)-24-(*)-HB45-12	20	8 ³ / ₄	11 ¹¹ / ₁₆
12	30	AUF(t)-30-(*)-HB45-12	22 ¹ / ₁₆	9 ³ / ₈	12 ¹⁵ / ₁₆
12	36	AUF(t)-36-(*)-HB45-12	24 ³ / ₁₆	10	14 ³ / ₁₆
12	42	AUF(t)-42-(*)-HB45-12	26 ⁵ / ₁₆	10 ¹⁵ / ₁₆	15 ⁷ / ₁₆
24	6	AUF(t)-06-(*)-HB45-24	22 ¹ / ₁₆	9 ³ / ₈	12 ¹⁵ / ₁₆
24	9	AUF(t)-09-(*)-HB45-24	23 ³ / ₈	9 ⁹ / ₁₆	13 ³ / ₁₆
24	12	AUF(t)-12-(*)-HB45-24	24 ³ / ₁₆	10	14 ³ / ₁₆
24	18	AUF(t)-18-(*)-HB45-24	26 ⁵ / ₁₆	10 ¹⁵ / ₁₆	15 ⁷ / ₁₆
24	24	AUF(t)-24-(*)-HB45-24	28 ⁷ / ₁₆	11 ¹³ / ₁₆	16 ¹¹ / ₁₆
24	30	AUF(t)-30-(*)-HB45-24	30 ⁹ / ₁₆	12 ¹ / ₁₆	17 ¹⁵ / ₁₆
24	36	AUF(t)-36-(*)-HB45-24	32 ¹¹ / ₁₆	13 ³ / ₁₆	19 ¹ / ₈
24	42	AUF(t)-42-(*)-HB45-24	34 ¹³ / ₁₆	14 ⁷ / ₈	20 ³ / ₈
36	6	AUF(t)-06-(*)-HB45-36	30 ⁹ / ₁₆	12 ¹ / ₁₆	17 ¹⁵ / ₁₆
36	9	AUF(t)-09-(*)-HB45-36	31 ⁵ / ₈	13 ³ / ₈	18 ⁹ / ₁₆
36	12	AUF(t)-12-(*)-HB45-36	32 ¹¹ / ₁₆	13 ³ / ₁₆	19 ¹ / ₈
36	18	AUF(t)-18-(*)-HB45-36	34 ¹³ / ₁₆	14 ⁷ / ₁₆	20 ³ / ₈
36	24	AUF(t)-24-(*)-HB45-36	36 ¹⁵ / ₁₆	15 ⁵ / ₁₆	21 ⁵ / ₈
36	30	AUF(t)-30-(*)-HB45-36	39 ¹ / ₁₆	16 ³ / ₁₆	22 ⁷ / ₈
36	36	AUF(t)-36-(*)-HB45-36	41 ³ / ₁₆	17 ¹ / ₁₆	24 ¹ / ₈
36	42	AUF(t)-42-(*)-HB45-36	43 ⁵ / ₁₆	17 ¹⁵ / ₁₆	25 ³ / ₈
48	6	AUF(t)-06-(*)-HB45-48	39 ¹ / ₁₆	16 ³ / ₁₆	22 ⁷ / ₈
48	9	AUF(t)-09-(*)-HB45-48	40 ¹ / ₈	16 ³ / ₈	23 ¹ / ₂
48	12	AUF(t)-12-(*)-HB45-48	41 ³ / ₁₆	17 ¹ / ₁₆	24 ¹ / ₈
48	18	AUF(t)-18-(*)-HB45-48	43 ⁵ / ₁₆	17 ⁷ / ₁₆	25 ³ / ₈
48	24	AUF(t)-24-(*)-HB45-48	45 ⁷ / ₁₆	18 ³ / ₁₆	26 ⁵ / ₈
48	30	AUF(t)-30-(*)-HB45-48	47 ⁹ / ₁₆	19 ¹¹ / ₁₆	27 ⁷ / ₈
48	36	AUF(t)-36-(*)-HB45-48	49 ¹¹ / ₁₆	20 ⁹ / ₁₆	29 ¹ / ₈
48	42	AUF(t)-42-(*)-HB45-48	51 ¹³ / ₁₆	21 ⁷ / ₁₆	30 ³ / ₈

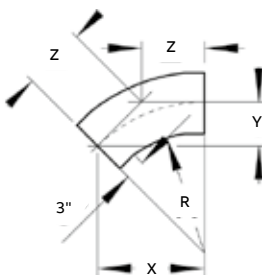

(t) Insert side rail height. (*) Insert bottom style to complete cat. no. Includes 1 pair of splice plates with hardware.
 T&B aluminum cable tray is composed of two distinct systems, H-style and U-style. These systems are interchangeable.

Part numbering system

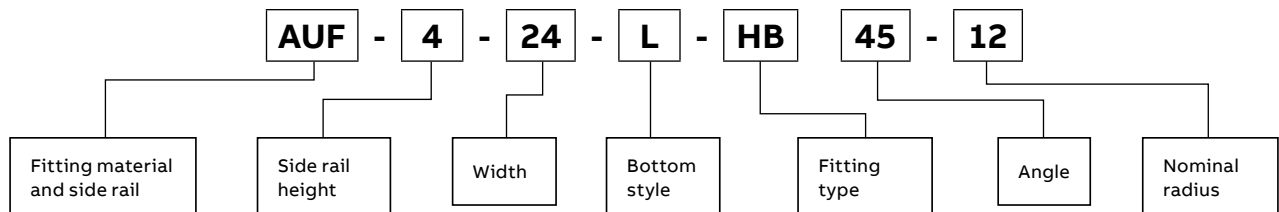

30° Horizontal bend – U-style

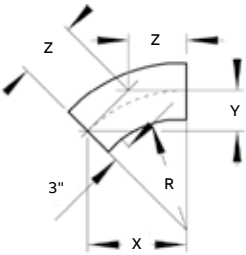
	Nominal radius (in.)	Nominal width (in.)	Cat. no.	Dimensions (in.)		
				X	Y	Z
	12	6	AUF(t)-06-(*)-HB30-12	11 ⁵ / ₈	3 ¹ / ₈	6 ³ / ₁₆
	12	9	AUF(t)-09-(*)-HB30-12	12 ³ / ₈	3 ⁹ / ₁₆	6 ⁶ / ₈
	12	12	AUF(t)-12-(*)-HB30-12	13 ¹ / ₂	3 ¹ / ₂	7
	12	18	AUF(t)-18-(*)-HB30-12	14 ⁵ / ₈	3 ¹⁵ / ₁₆	7 ¹³ / ₁₆
	12	24	AUF(t)-24-(*)-HB30-12	16 ¹ / ₈	4 ⁵ / ₁₆	8 ⁵ / ₈
	12	30	AUF(t)-30-(*)-HB30-12	17 ⁵ / ₈	4 ¹¹ / ₁₆	9 ⁷ / ₁₆
	12	36	AUF(t)-36-(*)-HB30-12	19 ¹ / ₈	5 ¹ / ₈	10 ¹ / ₄
	12	42	AUF(t)-42-(*)-HB30-12	20 ⁵ / ₈	5 ¹ / ₂	11 ¹ / ₁₆
	24	6	AUF(t)-06-(*)-HB30-24	17 ⁵ / ₈	4 ¹¹ / ₁₆	9 ⁷ / ₁₆
	24	9	AUF(t)-09-(*)-HB30-24	18 ³ / ₈	4 ¹⁵ / ₁₆	9 ¹³ / ₁₆
	24	12	AUF(t)-12-(*)-HB30-24	19 ¹ / ₈	5 ¹ / ₁₆	10 ⁴ / ₁₆
	24	18	AUF(t)-18-(*)-HB30-24	20 ⁵ / ₈	5 ⁵ / ₁₆	11 ¹ / ₁₆
	24	24	AUF(t)-24-(*)-HB30-24	22 ¹ / ₈	5 ¹⁵ / ₁₆	11 ¹³ / ₁₆
	24	30	AUF(t)-30-(*)-HB30-24	23 ³ / ₈	6 ¹ / ₁₆	12 ¹⁰ / ₁₆
	24	36	AUF(t)-36-(*)-HB30-24	25 ¹ / ₈	6 ¹³ / ₁₆	13 ⁷ / ₁₆
	24	42	AUF(t)-42-(*)-HB30-24	26 ⁵ / ₈	7 ¹ / ₈	14 ¹ / ₄
36	6	AUF(t)-06-(*)-HB30-36	23 ³ / ₈	6 ¹ / ₁₆	12 ⁵ / ₈	
36	9	AUF(t)-09-(*)-HB30-36	24 ³ / ₈	6 ¹ / ₂	13 ³ / ₁₆	
36	12	AUF(t)-12-(*)-HB30-36	25 ¹ / ₈	6 ³ / ₄	13 ⁷ / ₁₆	
36	18	AUF(t)-18-(*)-HB30-36	26 ⁵ / ₈	7 ¹ / ₄	14 ¹ / ₄	
36	24	AUF(t)-24-(*)-HB30-36	28 ¹ / ₈	7 ¹ / ₂	15 ¹ / ₁₆	
36	30	AUF(t)-30-(*)-HB30-36	29 ⁵ / ₈	7 ¹⁵ / ₁₆	15 ⁷ / ₈	
36	36	AUF(t)-36-(*)-HB30-36	31 ¹ / ₈	8 ⁵ / ₁₆	16 ¹¹ / ₁₆	
36	42	AUF(t)-42-(*)-HB30-36	32 ⁵ / ₈	8 ³ / ₄	17 ¹ / ₂	
	48	6	AUF(t)-06-(*)-HB30-48	29 ⁵ / ₈	7 ¹⁵ / ₁₆	15 ⁷ / ₈
	48	9	AUF(t)-09-(*)-HB30-48	30 ³ / ₈	8 ¹ / ₈	16 ¹ / ₄
	48	12	AUF(t)-12-(*)-HB30-48	31 ¹ / ₈	8 ⁹ / ₁₆	16 ¹¹ / ₁₆
	48	18	AUF(t)-18-(*)-HB30-48	32 ⁵ / ₈	8 ³ / ₄	17 ¹ / ₂
	48	24	AUF(t)-24-(*)-HB30-48	34 ¹ / ₈	9 ¹ / ₈	18 ¹ / ₄
	48	30	AUF(t)-30-(*)-HB30-48	35 ⁵ / ₈	9 ⁹ / ₁₆	19 ¹ / ₁₆
	48	36	AUF(t)-36-(*)-HB30-48	37 ¹ / ₈	9 ¹⁵ / ₁₆	19 ⁷ / ₈
	48	42	AUF(t)-42-(*)-HB30-48	38 ⁵ / ₈	10 ⁵ / ₁₆	20 ¹¹ / ₁₆

(t) Insert side rail height. (*) Insert bottom style to complete cat. no. Includes 1 pair of splice plates with hardware.

T&B aluminum cable tray is composed of two distinct systems, H-style and U-style. These systems are interchangeable.

Selection guide

- Inside tray widths: 6, 9, 12, 18, 24, 30, 36, 42 in.
- Angle: 45°, 30°
- Nominal radius: 12, 24, 36, 48 in.
- Bottom styles: L– ladder, V– ventilated, S– solid
- Side rail heights: 4– 7 in.

Aluminum fittings

45°/30° H-style horizontal bend fittings

45° Horizontal bend – H-style

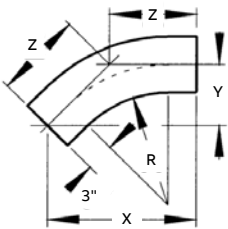

Nominal radius (in.)	Nominal width (in.)	Cat. no.	Dimensions (in.)		
			X	Y	Z
12	6	AHF(t)-06-(*)-HB45-12	15 ³ / ₄	6 ¹ / ₂	9 ³ / ₁₆
12	9	AHF(t)-09-(*)-HB45-12	16 ¹³ / ₁₆	6 ⁹ / ₁₆	9 ¹³ / ₁₆
12	12	AHF(t)-12-(*)-HB45-12	17 ⁷ / ₈	7 ³ / ₈	10 ⁷ / ₁₆
12	18	AHF(t)-18-(*)-HB45-12	20	8 ³ / ₄	11 ¹¹ / ₁₆
12	24	AHF(t)-24-(*)-HB45-12	22 ³ / ₁₆	9 ³ / ₈	12 ¹⁵ / ₁₆
12	30	AHF(t)-30-(*)-HB45-12	24 ³ / ₁₆	10	14 ³ / ₁₆
12	36	AHF(t)-36-(*)-HB45-12	26 ⁵ / ₁₆	10 ¹⁵ / ₁₆	15 ⁷ / ₁₆
12	42	AHF(t)-42-(*)-HB45-12	28 ⁷ / ₁₆	11 ⁷ / ₈	16 ¹¹ / ₁₆
24	6	AHF(t)-06-(*)-HB45-24	24 ³ / ₁₆	10	14 ³ / ₁₆
24	9	AHF(t)-09-(*)-HB45-24	25 ³ / ₄	10 ¹ / ₂	14 ¹³ / ₁₆
24	12	AHF(t)-12-(*)-HB45-24	26 ⁵ / ₁₆	10 ¹⁵ / ₁₆	15 ⁷ / ₁₆
24	18	AHF(t)-18-(*)-HB45-24	28 ⁷ / ₁₆	11 ¹³ / ₁₆	16 ¹¹ / ₁₆
24	24	AHF(t)-24-(*)-HB45-24	30 ⁹ / ₁₆	12 ¹¹ / ₁₆	17 ¹⁵ / ₁₆
24	30	AHF(t)-30-(*)-HB45-24	32 ¹¹ / ₁₆	13 ⁹ / ₁₆	19 ³ / ₈
24	36	AHF(t)-36-(*)-HB45-24	34 ¹³ / ₁₆	14 ⁷ / ₈	20 ³ / ₈
24	42	AHF(t)-42-(*)-HB45-24	36 ¹⁵ / ₁₆	15 ³ / ₄	21 ³ / ₈
36	6	AHF(t)-06-(*)-HB45-36	32 ¹¹ / ₁₆	13 ⁹ / ₁₆	19 ³ / ₈
36	9	AHF(t)-09-(*)-HB45-36	33 ³ / ₄	14	19 ³ / ₄
36	12	AHF(t)-12-(*)-HB45-36	34 ¹³ / ₁₆	14 ⁷ / ₁₆	20 ³ / ₈
36	18	AHF(t)-18-(*)-HB45-36	36 ¹⁵ / ₁₆	15 ⁵ / ₁₆	21 ³ / ₈
36	24	AHF(t)-24-(*)-HB45-36	39 ³ / ₁₆	16 ³ / ₁₆	22 ⁷ / ₈
36	30	AHF(t)-30-(*)-HB45-36	41 ³ / ₁₆	17 ¹ / ₁₆	24 ¹ / ₈
36	36	AHF(t)-36-(*)-HB45-36	43 ⁵ / ₁₆	17 ¹⁵ / ₁₆	25 ³ / ₈
36	42	AHF(t)-42-(*)-HB45-36	45 ⁷ / ₁₆	18 ¹³ / ₁₆	26 ³ / ₈
48	6	AHF(t)-06-(*)-HB45-48	41 ³ / ₁₆	17 ¹ / ₁₆	24 ¹ / ₈
48	9	AHF(t)-09-(*)-HB45-48	42 ³ / ₄	17 ¹ / ₂	24 ³ / ₄
48	12	AHF(t)-12-(*)-HB45-48	43 ⁵ / ₁₆	17 ¹⁵ / ₁₆	25 ³ / ₈
48	18	AHF(t)-18-(*)-HB45-48	45 ⁷ / ₁₆	18 ³ / ₁₆	26 ³ / ₈
48	24	AHF(t)-24-(*)-HB45-48	47 ⁹ / ₁₆	19 ¹¹ / ₁₆	27 ³ / ₄
48	30	AHF(t)-30-(*)-HB45-48	49 ¹¹ / ₁₆	20 ⁹ / ₁₆	29 ³ / ₈
48	36	AHF(t)-36-(*)-HB45-48	51 ¹³ / ₁₆	21 ⁷ / ₁₆	30 ³ / ₈
48	42	AHF(t)-42-(*)-HB45-48	53 ¹⁵ / ₁₆	22 ⁵ / ₁₆	31 ³ / ₈

(t) Insert side rail height. (*) Insert bottom style to complete cat. no. Includes 1 pair of splice plates with hardware.
 T&B aluminum cable tray is composed of two distinct systems, H-style and U-style. These systems are interchangeable.

Part numbering system

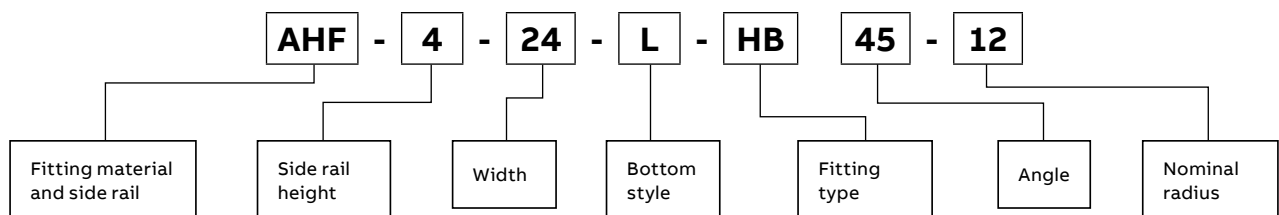

30° Horizontal bend – H-style

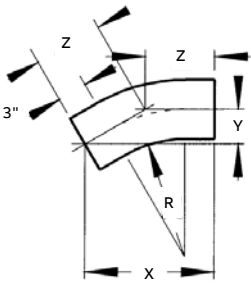
	Nominal radius (in.)	Nominal width (in.)	Cat. no.	Dimensions (in.)		
				X	Y	Z
	12	6	AHF(t)-06-(*)-HB30-12	13 ¹ / ₈	3 ¹ / ₂	7
	12	9	AHF(t)-09-(*)-HB30-12	13 ⁷ / ₈	3 ¹¹ / ₁₆	7 ¹ / ₁₆
	12	12	AHF(t)-12-(*)-HB30-12	14 ⁵ / ₈	3 ¹⁵ / ₁₆	7 ¹³ / ₁₆
	12	18	AHF(t)-18-(*)-HB30-12	16 ¹ / ₈	4 ⁵ / ₁₆	8 ⁵ / ₈
	12	24	AHF(t)-24-(*)-HB30-12	17 ⁷ / ₈	4 ¹¹ / ₁₆	9 ⁷ / ₈
	12	30	AHF(t)-30-(*)-HB30-12	19 ¹ / ₈	5 ¹ / ₈	10 ¹ / ₄
	12	36	AHF(t)-36-(*)-HB30-12	20 ⁵ / ₈	5 ¹ / ₂	11 ¹ / ₁₆
	12	42	AHF(t)-42-(*)-HB30-12	22 ¹ / ₈	5 ⁷ / ₈	12 ³ / ₁₆
	24	6	AHF(t)-06-(*)-HB30-24	19 ¹ / ₈	5 ¹ / ₈	10 ¹ / ₄
	24	9	AHF(t)-09-(*)-HB30-24	19 ⁷ / ₈	5 ¹⁵ / ₁₆	10 ⁵ / ₈
	24	12	AHF(t)-12-(*)-HB30-24	20 ⁵ / ₈	5 ¹ / ₂	11 ¹ / ₁₆
	24	18	AHF(t)-18-(*)-HB30-24	22 ¹ / ₈	5 ⁵ / ₁₆	11 ¹³ / ₁₆
	24	24	AHF(t)-24-(*)-HB30-24	23 ³ / ₈	6 ¹ / ₁₆	12 ³ / ₈
	24	30	AHF(t)-30-(*)-HB30-24	25 ¹ / ₈	6 ³ / ₄	13 ³ / ₁₆
	24	36	AHF(t)-36-(*)-HB30-24	26 ⁵ / ₈	7 ¹ / ₈	14 ¹ / ₄
	24	42	AHF(t)-42-(*)-HB30-24	28 ¹ / ₈	7 ¹ / ₂	15 ⁵ / ₁₆
	36	6	AHF(t)-06-(*)-HB30-36	25 ¹ / ₈	6 ³ / ₄	13 ³ / ₁₆
	36	9	AHF(t)-09-(*)-HB30-36	25 ⁷ / ₈	6 ¹⁵ / ₁₆	13 ³ / ₈
	36	12	AHF(t)-12-(*)-HB30-36	26 ⁵ / ₈	7 ¹ / ₈	14 ¹ / ₄
	36	18	AHF(t)-18-(*)-HB30-36	28 ¹ / ₈	7 ¹ / ₂	15 ¹ / ₁₆
	36	24	AHF(t)-24-(*)-HB30-36	29 ¹ / ₈	7 ¹⁵ / ₁₆	15 ⁷ / ₈
	36	30	AHF(t)-30-(*)-HB30-36	31 ¹ / ₈	8 ⁵ / ₁₆	16 ¹¹ / ₁₆
	36	36	AHF(t)-36-(*)-HB30-36	32 ⁵ / ₈	8 ³ / ₄	17 ¹ / ₂
	36	42	AHF(t)-42-(*)-HB30-36	34 ¹ / ₈	9 ¹ / ₈	18 ⁵ / ₁₆
	48	6	AHF(t)-06-(*)-HB30-48	31 ¹ / ₈	8 ⁵ / ₁₆	16 ¹¹ / ₁₆
	48	9	AHF(t)-09-(*)-HB30-48	31 ⁷ / ₈	8 ⁹ / ₁₆	17 ¹ / ₁₆
	48	12	AHF(t)-12-(*)-HB30-48	32 ⁵ / ₈	8 ³ / ₄	17 ¹ / ₂
	48	18	AHF(t)-18-(*)-HB30-48	34 ¹ / ₈	9 ¹ / ₈	18 ¹ / ₄
48	24	AHF(t)-24-(*)-HB30-48	35 ⁵ / ₈	9 ⁹ / ₁₆	19 ¹ / ₁₆	
48	30	AHF(t)-30-(*)-HB30-48	37 ¹ / ₈	9 ¹⁵ / ₁₆	19 ⁷ / ₈	
48	36	AHF(t)-36-(*)-HB30-48	38 ⁵ / ₈	10 ⁵ / ₁₆	20 ¹¹ / ₁₆	
48	42	AHF(t)-42-(*)-HB30-48	40 ¹ / ₈	10 ¹¹ / ₁₆	21 ¹ / ₂	

(t) Insert side rail height. (*) Insert bottom style to complete cat. no. Includes 1 pair of splice plates with hardware.

T&B aluminum cable tray is composed of two distinct systems, H-style and U-style. These systems are interchangeable.

Selection guide

- Inside tray widths: 6, 9, 12, 18, 24, 30, 36, 42 in.
- Angle: 45°, 30°
- Nominal radius: 12, 24, 36, 48 in.
- Bottom styles: L– ladder, V– ventilated, S– solid
- Side rail heights: 4–7 in.

Aluminum fittings

U-style horizontal tee and cross fittings

Horizontal tee – U-style

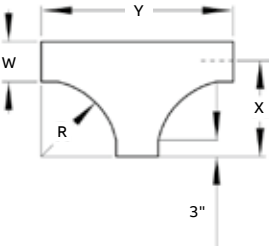
Nominal radius (in.)	Nominal width (in.)	Cat. no.	Dimensions (in.)	
			X	Y
12	6	AUF(t)-06-(*)-HT12	15	30
12	9	AUF(t)-09-(*)-HT12	16½	33
12	12	AUF(t)-12-(*)-HT12	18	36
12	18	AUF(t)-18-(*)-HT12	21	42
12	24	AUF(t)-24-(*)-HT12	24	48
12	30	AUF(t)-30-(*)-HT12	27	54
12	36	AUF(t)-36-(*)-HT12	30	60
12	42	AUF(t)-42-(*)-HT12	33	66
24	6	AUF(t)-06-(*)-HT24	27	54
24	9	AUF(t)-09-(*)-HT24	28½	57
24	12	AUF(t)-12-(*)-HT24	30	60
24	18	AUF(t)-18-(*)-HT24	33	66
24	24	AUF(t)-24-(*)-HT24	36	72
24	30	AUF(t)-30-(*)-HT24	39	78
24	36	AUF(t)-36-(*)-HT24	42	84
24	42	AUF(t)-42-(*)-HT24	45	90
36	6	AUF(t)-06-(*)-HT36	39	78
36	9	AUF(t)-09-(*)-HT36	40½	81
36	12	AUF(t)-12-(*)-HT36	42	84
36	18	AUF(t)-18-(*)-HT36	45	90
36	24	AUF(t)-24-(*)-HT36	48	96
36	30	AUF(t)-30-(*)-HT36	51	102
36	36	AUF(t)-36-(*)-HT36	54	108
36	42	AUF(t)-42-(*)-HT36	57	114
48	6	AUF(t)-06-(*)-HT48	51	102
48	9	AUF(t)-09-(*)-HT48	52½	105
48	12	AUF(t)-12-(*)-HT48	54	108
48	18	AUF(t)-18-(*)-HT48	57	114
48	24	AUF(t)-24-(*)-HT48	60	120
48	30	AUF(t)-30-(*)-HT48	63	126
48	36	AUF(t)-36-(*)-HT48	66	132
48	42	AUF(t)-42-(*)-HT48	69	138

(t) Insert side rail height. (*) Insert bottom style to complete cat. no. Tees include 2 pairs/crosses include 3 pairs of splice plates with hardware. T&B aluminum cable tray is composed of two distinct systems, H-style and U-style. These systems are interchangeable.

Part numbering system

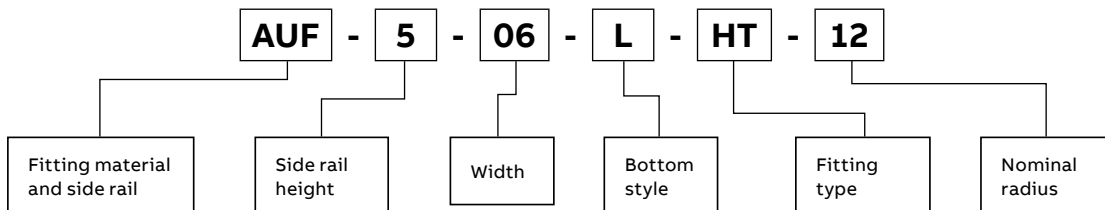

Horizontal cross – U-style

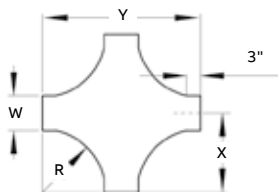
Nominal radius (in.)	Nominal width (in.)	Cat. no.	Dimensions (in.)	
			X	Y
12	6	AUF(t)-06-(*)-HX12	15	30
12	9	AUF(t)-09-(*)-HX12	16½	33
12	12	AUF(t)-12-(*)-HX12	18	36
12	18	AUF(t)-18-(*)-HX12	21	42
12	24	AUF(t)-24-(*)-HX12	24	48
12	30	AUF(t)-30-(*)-HX12	27	54
12	36	AUF(t)-36-(*)-HX12	30	60
12	42	AUF(t)-42-(*)-HX12	33	66
24	6	AUF(t)-06-(*)-HX24	27	54
24	9	AUF(t)-09-(*)-HX24	28½	57
24	12	AUF(t)-12-(*)-HX24	30	60
24	18	AUF(t)-18-(*)-HX24	33	66
24	24	AUF(t)-24-(*)-HX24	36	72
24	30	AUF(t)-30-(*)-HX24	39	78
24	36	AUF(t)-36-(*)-HX24	42	84
24	42	AUF(t)-42-(*)-HX24	45	90
36	6	AUF(t)-06-(*)-HX36	39	78
36	9	AUF(t)-09-(*)-HX36	40½	81
36	12	AUF(t)-12-(*)-HX36	42	84
36	18	AUF(t)-18-(*)-HX36	45	90
36	24	AUF(t)-24-(*)-HX36	48	96
36	30	AUF(t)-30-(*)-HX36	51	102
36	36	AUF(t)-36-(*)-HX36	54	108
36	42	AUF(t)-42-(*)-HX36	57	114
48	6	AUF(t)-06-(*)-HX48	51	102
48	9	AUF(t)-09-(*)-HX48	52½	105
48	12	AUF(t)-12-(*)-HX48	54	108
48	18	AUF(t)-18-(*)-HX48	57	114
48	24	AUF(t)-24-(*)-HX48	60	120
48	30	AUF(t)-30-(*)-HX48	63	126
48	36	AUF(t)-36-(*)-HX48	66	132
48	42	AUF(t)-42-(*)-HX48	69	138

(t) Insert side rail height. (*) Insert bottom style to complete cat. no. Tees include 2 pairs/crosses include 3 pairs of splice plates with hardware. T&B aluminum cable tray is composed of two distinct systems, H-style and U-style. These systems are interchangeable.

Selection guide

- Inside tray widths: 6, 9, 12, 18, 24, 30, 36, 42 in.
- Nominal radius: 12, 24, 36, 48 in.
- Bottom styles: L– ladder, V– ventilated, S– solid
- Side rail heights: 4–7 in.

Aluminum fittings

H-style horizontal tee and cross fittings

Horizontal tee – H-style



Nominal radius (in.)	Nominal width (in.)	Cat. no.	Dimensions (in.)	
			X	Y
12	6	AHF(t)-06-(*)-HT12	18	36
12	9	AHF(t)-09-(*)-HT12	19½	39
12	12	AHF(t)-12-(*)-HT12	21	42
12	18	AHF(t)-18-(*)-HT12	24	48
12	24	AHF(t)-24-(*)-HT12	27	54
12	30	AHF(t)-30-(*)-HT12	30	60
12	36	AHF(t)-36-(*)-HT12	33	66
12	42	AHF(t)-42-(*)-HT12	36	72
24	6	AHF(t)-06-(*)-HT24	30	60
24	9	AHF(t)-09-(*)-HT24	31½	63
24	12	AHF(t)-12-(*)-HT24	33	66
24	18	AHF(t)-18-(*)-HT24	36	72
24	24	AHF(t)-24-(*)-HT24	39	78
24	30	AHF(t)-30-(*)-HT24	42	84
24	36	AHF(t)-36-(*)-HT24	45	90
24	42	AHF(t)-42-(*)-HT24	48	96
36	6	AHF(t)-06-(*)-HT36	42	84
36	9	AHF(t)-09-(*)-HT36	43½	87
36	12	AHF(t)-12-(*)-HT36	45	90
36	18	AHF(t)-18-(*)-HT36	48	96
36	24	AHF(t)-24-(*)-HT36	51	102
36	30	AHF(t)-30-(*)-HT36	54	108
36	36	AHF(t)-36-(*)-HT36	57	114
36	42	AHF(t)-42-(*)-HT36	60	120
48	6	AHF(t)-06-(*)-HT48	54	108
48	9	AHF(t)-09-(*)-HT48	55½	111
48	12	AHF(t)-12-(*)-HT48	57	114
48	18	AHF(t)-18-(*)-HT48	60	120
48	24	AHF(t)-24-(*)-HT48	63	126
48	30	AHF(t)-30-(*)-HT48	66	132
48	36	AHF(t)-36-(*)-HT48	69	138
48	42	AHF(t)-42-(*)-HT48	72	144

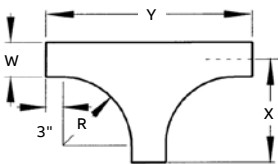

(t) Insert side rail height. (*) Insert bottom style to complete cat. no. Tees include 2 pairs/crosses include 3 pairs of splice plates with hardware. T&B aluminum cable tray is composed of two distinct systems, H-style and U-style. These systems are interchangeable.

Part numbering system

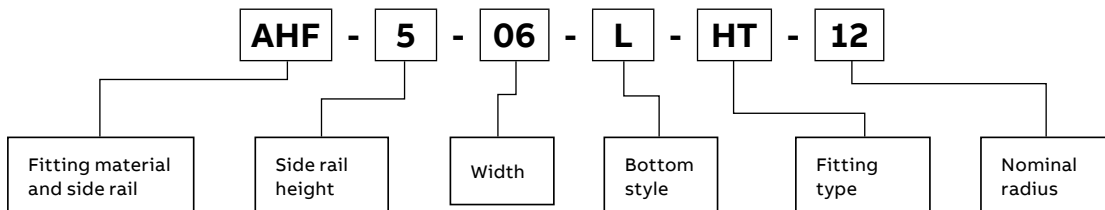

Horizontal cross – H-style

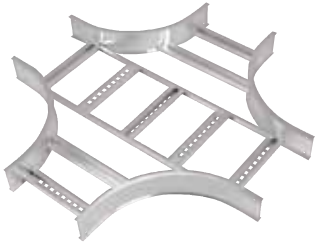
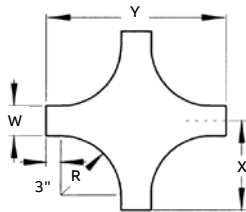
	Nominal radius (in.)	Nominal width (in.)	Cat. no.	Dimensions (in.)	
				X	Y
	12	6	AHF(t)-06-(*)-HX12	18	36
	12	9	AHF(t)-09-(*)-HX12	19½	39
	12	12	AHF(t)-12-(*)-HX12	21	42
	12	18	AHF(t)-18-(*)-HX12	24	48
	12	24	AHF(t)-24-(*)-HX12	27	54
	12	30	AHF(t)-30-(*)-HX12	30	60
	12	36	AHF(t)-36-(*)-HX12	33	66
	12	42	AHF(t)-42-(*)-HX12	36	72
	24	6	AHF(t)-06-(*)-HX24	30	60
	24	9	AHF(t)-09-(*)-HX24	31½	63
	24	12	AHF(t)-12-(*)-HX24	33	66
	24	18	AHF(t)-18-(*)-HX24	36	72
	24	24	AHF(t)-24-(*)-HX24	39	78
	24	30	AHF(t)-30-(*)-HX24	42	84
	24	36	AHF(t)-36-(*)-HX24	45	90
	24	42	AHF(t)-42-(*)-HX24	48	96
	36	6	AHF(t)-06-(*)-HX36	42	84
	36	9	AHF(t)-09-(*)-HX36	43½	87
	36	12	AHF(t)-12-(*)-HX36	45	90
	36	18	AHF(t)-18-(*)-HX36	48	96
	36	24	AHF(t)-24-(*)-HX36	51	102
	36	30	AHF(t)-30-(*)-HX36	54	108
	36	36	AHF(t)-36-(*)-HX36	57	114
	36	42	AHF(t)-42-(*)-HX36	60	120
	48	6	AHF(t)-06-(*)-HX48	54	108
	48	9	AHF(t)-09-(*)-HX48	55½	111
	48	12	AHF(t)-12-(*)-HX48	57	114
	48	18	AHF(t)-18-(*)-HX48	60	120
48	24	AHF(t)-24-(*)-HX48	63	126	
48	30	AHF(t)-30-(*)-HX48	66	132	
48	36	AHF(t)-36-(*)-HX48	69	138	
48	42	AHF(t)-42-(*)-HX48	72	144	

(t) Insert side rail height. (*) Insert bottom style to complete cat. no. Tees include 2 pairs/crosses include 3 pairs of splice plates with hardware. T&B aluminum cable tray is composed of two distinct systems, H-style and U-style. These systems are interchangeable.

Selection guide

- Inside tray widths: 6, 9, 12, 18, 24, 30, 36, 42 in.
- Nominal radius: 12, 24, 36, 48 in.
- Bottom styles: L– ladder, V– ventilated, S– solid
- Side rail heights: 4–7 in.

Aluminum fittings

U-style horizontal reducing tee fittings

Selection guide

- Tray widths W1: 42, 36, 30, 24, 18, 12, 9 in.
- Tray widths W2: 36, 30, 24, 18, 12, 9, 6 in.
- Nominal radius: 12, 24, 36, 48 in.
- Bottom styles: L– ladder, V– ventilated, S– solid
- Side rail heights: 4–7 in.

Horizontal reducing tee – U-style

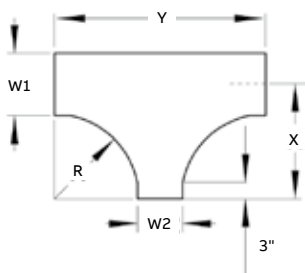
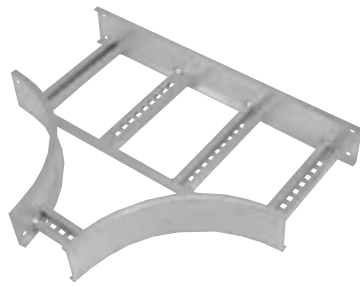

Widths (in.)			Dimensions (in.)							
			(+ 12 in. Nominal radius)		(+ 24 in. Nominal radius)		(+ 36 in. Nominal radius)		(+ 48 in. Nominal radius)	
W1	W2	Cat. no.	X	Y	X	Y	X	Y	X	Y
42	36	AUF(+)-4236-(*)-RT(+)	33	60	45	84	57	108	69	132
42	30	AUF(+)-4230-(*)-RT(+)	33	54	45	78	57	102	69	126
42	24	AUF(+)-4224-(*)-RT(+)	33	48	45	72	57	96	69	120
42	18	AUF(+)-4218-(*)-RT(+)	33	42	45	66	57	90	69	114
42	12	AUF(+)-4212-(*)-RT(+)	33	36	45	60	57	84	69	108
42	9	AUF(+)-4209-(*)-RT(+)	33	33	45	57	57	81	69	105
42	6	AUF(+)-4206-(*)-RT(+)	33	30	45	54	57	78	69	102
36	30	AUF(+)-3630-(*)-RT(+)	30	54	42	78	54	102	66	126
36	24	AUF(+)-3624-(*)-RT(+)	30	48	42	72	54	96	66	120
36	18	AUF(+)-3618-(*)-RT(+)	30	42	42	66	54	90	66	114
36	12	AUF(+)-3612-(*)-RT(+)	30	36	42	60	54	84	66	108
36	9	AUF(+)-3609-(*)-RT(+)	30	33	42	57	54	81	66	105
36	6	AUF(+)-3606-(*)-RT(+)	30	30	42	54	54	78	66	102
30	24	AUF(+)-3024-(*)-RT(+)	27	48	39	72	51	96	63	120
30	18	AUF(+)-3018-(*)-RT(+)	27	42	39	66	51	90	63	114
30	12	AUF(+)-3012-(*)-RT(+)	27	36	39	60	51	84	63	108
30	9	AUF(+)-3009-(*)-RT(+)	27	33	39	57	51	81	63	105
30	6	AUF(+)-3006-(*)-RT(+)	27	30	39	54	51	78	63	102
24	18	AUF(+)-2418-(*)-RT(+)	24	42	36	66	48	90	60	114
24	12	AUF(+)-2412-(*)-RT(+)	24	36	36	60	48	84	60	108
24	9	AUF(+)-2409-(*)-RT(+)	24	33	36	57	48	81	60	105
24	6	AUF(+)-2406-(*)-RT(+)	24	30	36	54	48	78	60	102
18	12	AUF(+)-1812-(*)-RT(+)	21	36	33	60	45	84	57	108
18	9	AUF(+)-1809-(*)-RT(+)	21	33	33	57	45	81	57	105
18	6	AUF(+)-1806-(*)-RT(+)	21	30	33	54	45	78	57	102
12	9	AUF(+)-1209-(*)-RT(+)	18	33	30	57	42	81	54	105
12	6	AUF(+)-1206-(*)-RT(+)	18	30	30	54	42	78	54	102
9	6	AUF(+)-0906-(*)-RT(+)	16½	30	28½	54	40½	78	52½	102

(†) Insert side rail height. (*) Insert bottom style to complete cat. no. (+) Insert radius (12 in. – 48 in.). Includes 2 pairs of splice plates with hardware. T&B aluminum cable tray is composed of two distinct systems, H-style and U-style. These systems are interchangeable.

Part numbering system

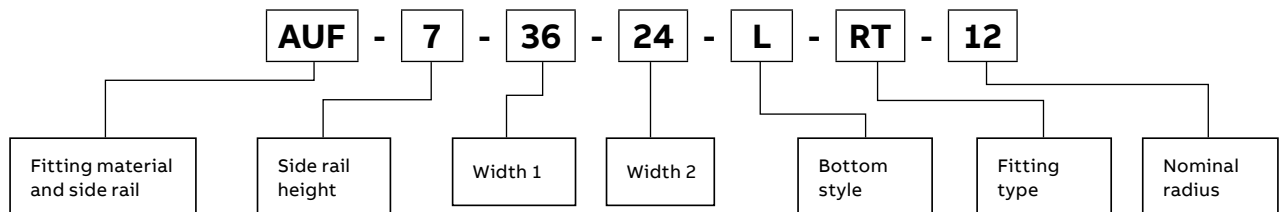

Aluminum fittings

H-style horizontal reducing tee fittings

Selection guide

- Tray widths W1: 42, 36, 30, 24, 18, 12, 9 in.
- Tray widths W2: 36, 30, 24, 18, 12, 9, 6 in.
- Nominal radius: 12, 24, 36, 48 in.
- Bottom styles: L– ladder, V– ventilated, S– solid
- Side rail heights: 4–7 in.

Horizontal reducing tee – H-style

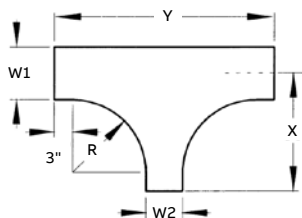
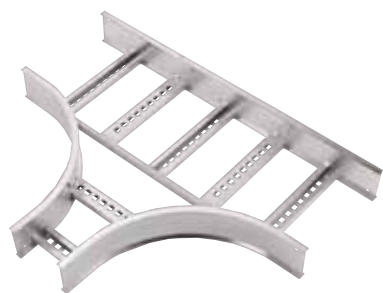

Widths (in.)			Dimensions (in.)							
			(+ 12 in. Nominal radius)		(+ 24 in. Nominal radius)		(+ 36 in. Nominal radius)		(+ 48 in. Nominal radius)	
W1	W2	Cat. no.	X	Y	X	Y	X	Y	X	Y
42	36	AHF(t)-4236-(*)-RT(+)	36	66	48	90	60	114	72	138
42	30	AHF(t)-4230-(*)-RT(+)	36	60	48	84	60	108	72	132
42	24	AHF(t)-4224-(*)-RT(+)	36	54	48	78	60	102	72	126
42	18	AHF(t)-4218-(*)-RT(+)	36	48	48	72	60	96	72	120
42	12	AHF(t)-4212-(*)-RT(+)	36	42	48	66	60	90	72	114
42	9	AHF(t)-4209-(*)-RT(+)	36	39	48	63	60	87	72	111
42	6	AHF(t)-4206-(*)-RT(+)	36	36	48	60	60	84	72	108
36	30	AHF(t)-3630-(*)-RT(+)	33	60	45	84	57	108	69	132
36	24	AHF(t)-3624-(*)-RT(+)	33	54	45	78	57	102	69	126
36	18	AHF(t)-3618-(*)-RT(+)	33	48	45	72	57	96	69	120
36	12	AHF(t)-3612-(*)-RT(+)	33	42	45	66	57	90	69	114
36	9	AHF(t)-3609-(*)-RT(+)	33	39	45	63	57	87	69	111
36	6	AHF(t)-3606-(*)-RT(+)	33	36	45	60	57	84	69	108
30	24	AHF(t)-3024-(*)-RT(+)	30	54	42	78	54	102	66	126
30	18	AHF(t)-3018-(*)-RT(+)	30	48	42	72	54	96	66	120
30	12	AHF(t)-3012-(*)-RT(+)	30	42	42	66	54	90	66	114
30	9	AHF(t)-3009-(*)-RT(+)	30	39	42	63	54	87	66	111
30	6	AHF(t)-3006-(*)-RT(+)	30	36	42	60	54	84	66	108
24	18	AHF(t)-2418-(*)-RT(+)	27	48	39	72	51	96	63	120
24	12	AHF(t)-2412-(*)-RT(+)	27	42	39	66	51	90	63	114
24	9	AHF(t)-2409-(*)-RT(+)	27	39	39	63	51	87	63	111
24	6	AHF(t)-2406-(*)-RT(+)	27	36	39	60	51	84	63	108
18	12	AHF(t)-1812-(*)-RT(+)	24	42	36	66	48	90	60	114
18	9	AHF(t)-1809-(*)-RT(+)	24	39	36	63	48	87	60	111
18	6	AHF(t)-1806-(*)-RT(+)	24	36	36	60	48	84	60	108
12	9	AHF(t)-1209-(*)-RT(+)	21	39	33	63	45	87	57	111
12	6	AHF(t)-1206-(*)-RT(+)	21	36	33	60	45	84	57	108
9	6	AHF(t)-0906-(*)-RT(+)	19½	36	31½	60	43½	84	55½	108

(t) Insert side rail height. (*) Insert bottom style to complete cat. no. (+) Insert radius (12 in. – 48 in.). Includes 2 pairs of splice plates with hardware. T&B aluminum cable tray is composed of two distinct systems, H-style and U-style. These systems are interchangeable.

Part numbering system

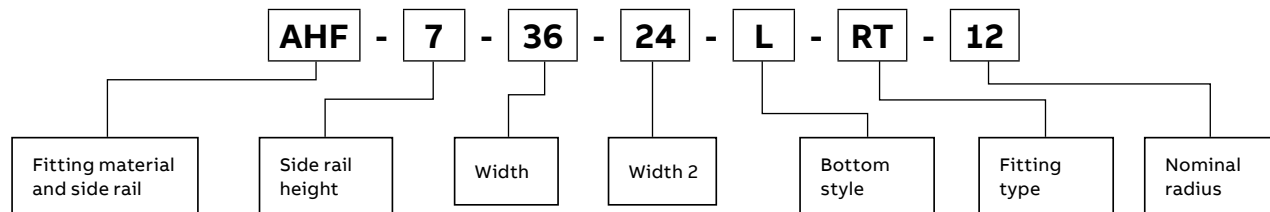

Aluminum fittings

U-style horizontal expanding tee fittings

Selection guide

- Tray widths W1: 36, 30, 24, 18, 12, 9, 6 in.
- Tray widths W2: 42, 36, 30, 24, 18, 12, 9 in.
- Nominal radius: 12, 24, 36, 48 in.
- Bottom styles: L- ladder, V- ventilated, S- solid
- Side rail heights: 4-7 in.

Horizontal expanding tee – U-style

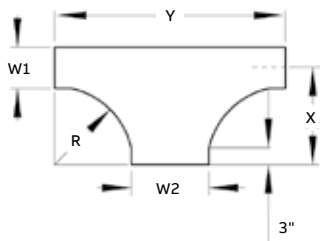

Widths (in.)			Dimensions (in.)							
			(+) 12 in. Nominal radius		(+) 24 in. Nominal radius		(+) 36 in. Nominal radius		(+) 48 in. Nominal radius	
W1	W2	Cat. no.	X	Y	X	Y	X	Y	X	Y
36	42	AUF(t)-3642-(*)-ET(+)	30	66	42	90	54	114	66	138
30	36	AUF(t)-3036-(*)-ET(+)	27	60	39	84	51	108	63	132
30	42	AUF(t)-3042-(*)-ET(+)	27	66	39	90	51	114	63	138
24	30	AUF(t)-2430-(*)-ET(+)	24	54	36	78	48	102	60	126
24	36	AUF(t)-2436-(*)-ET(+)	24	60	36	84	48	108	60	132
24	42	AUF(t)-2442-(*)-ET(+)	24	66	36	90	48	114	60	138
18	24	AUF(t)-1824-(*)-ET(+)	21	48	33	72	45	96	57	120
18	30	AUF(t)-1830-(*)-ET(+)	21	54	33	78	45	102	57	126
18	36	AUF(t)-1836-(*)-ET(+)	21	60	33	84	45	108	57	132
18	42	AUF(t)-1842-(*)-ET(+)	21	66	33	90	45	114	57	138
12	18	AUF(t)-1218-(*)-ET(+)	18	42	30	66	42	90	54	114
12	24	AUF(t)-1224-(*)-ET(+)	18	48	30	72	42	96	54	120
12	30	AUF(t)-1230-(*)-ET(+)	18	54	30	78	42	102	54	126
12	36	AUF(t)-1236-(*)-ET(+)	18	60	30	84	42	108	54	132
12	42	AUF(t)-1242-(*)-ET(+)	18	66	30	90	42	114	54	138
9	12	AUF(t)-0912-(*)-ET(+)	16½	36	28½	60	40½	84	52½	108
9	18	AUF(t)-0918-(*)-ET(+)	16½	42	28½	66	40½	90	52½	114
9	24	AUF(t)-0924-(*)-ET(+)	16½	48	28½	72	40½	96	52½	120
9	30	AUF(t)-0930-(*)-ET(+)	16½	54	28½	78	40½	102	52½	126
9	36	AUF(t)-0936-(*)-ET(+)	16½	60	28½	84	40½	108	52½	132
9	42	AUF(t)-0942-(*)-ET(+)	16½	66	28½	90	40½	114	52½	138
6	9	AUF(t)-0609-(*)-ET(+)	15	33	27	57	39	81	51	105
6	12	AUF(t)-0612-(*)-ET(+)	15	36	27	60	39	84	51	108
6	18	AUF(t)-0618-(*)-ET(+)	15	42	27	66	39	90	51	114
6	24	AUF(t)-0624-(*)-ET(+)	15	48	27	72	39	96	51	120
6	30	AUF(t)-0630-(*)-ET(+)	15	54	27	78	39	102	51	126
6	36	AUF(t)-0636-(*)-ET(+)	15	60	27	84	39	108	51	132
6	42	AUF(t)-0642-(*)-ET(+)	15	66	27	90	39	114	51	138

(t) Insert side rail height. (*) Insert bottom style to complete cat. no. (+) Insert radius (12 in. – 48 in.). Includes 2 pairs of splice plates with hardware. T&B aluminum cable tray is composed of two distinct systems, H-style and U-style. These systems are interchangeable.

Part numbering system

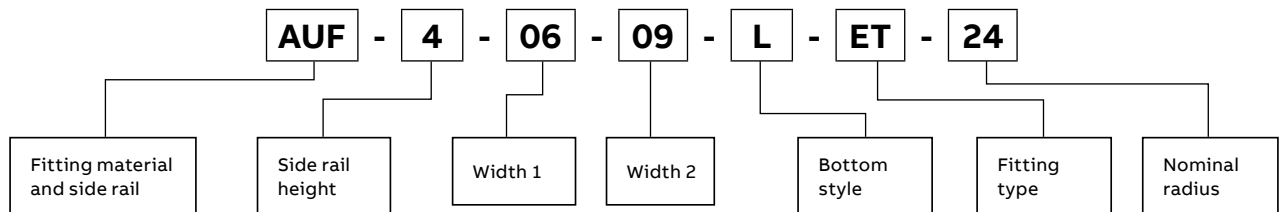

Aluminum fittings

H-style horizontal expanding tee fittings

Selection guide

- Tray widths W1: 36, 30, 24, 18, 12, 9, 6 in.
- Tray widths W2: 42, 36, 30, 24, 18, 12, 9 in.
- Nominal radius: 12, 24, 36, 48 in.
- Bottom styles: L- ladder, V- ventilated, S- solid
- Side rail heights: 4-7 in.

Horizontal expanding tee – H-style

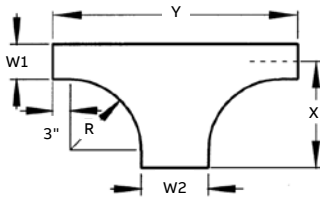
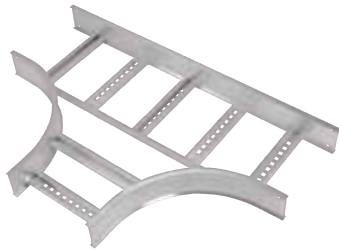

Widths (in.)			Dimensions (in.)							
			(+ 12 in. Nominal radius)		(+ 24 in. Nominal radius)		(+ 36 in. Nominal radius)		(+ 48 in. Nominal radius)	
W1	W2	Cat. no.	X	Y	X	Y	X	Y	X	Y
36	42	AHF(t)-3642-(*)-ET(+)	33	72	45	96	57	120	69	144
30	36	AHF(t)-3036-(*)-ET(+)	30	66	42	90	54	114	66	138
30	42	AHF(t)-3042-(*)-ET(+)	30	72	42	96	54	120	66	144
24	30	AHF(t)-2430-(*)-ET(+)	27	60	39	84	51	108	63	132
24	36	AHF(t)-2436-(*)-ET(+)	27	66	39	90	51	114	63	138
24	42	AHF(t)-2442-(*)-ET(+)	27	72	39	96	51	120	63	144
18	24	AHF(t)-1824-(*)-ET(+)	24	54	36	78	48	102	60	126
18	30	AHF(t)-1830-(*)-ET(+)	24	60	36	84	48	108	60	132
18	36	AHF(t)-1836-(*)-ET(+)	24	66	36	90	48	114	60	138
18	42	AHF(t)-1842-(*)-ET(+)	24	72	36	96	48	120	60	144
12	18	AHF(t)-1218-(*)-ET(+)	21	48	33	72	45	96	57	120
12	24	AHF(t)-1224-(*)-ET(+)	21	54	33	78	45	102	57	126
12	30	AHF(t)-1230-(*)-ET(+)	21	60	33	84	45	108	57	132
12	36	AHF(t)-1236-(*)-ET(+)	21	66	33	90	45	114	57	138
12	42	AHF(t)-1242-(*)-ET(+)	21	72	33	96	45	120	57	144
9	12	AHF(t)-0912-(*)-ET(+)	19½	42	31½	66	43½	90	55½	114
9	18	AHF(t)-0918-(*)-ET(+)	19½	48	31½	72	43½	96	55½	120
9	24	AHF(t)-0924-(*)-ET(+)	19½	54	31½	78	43½	102	55½	126
9	30	AHF(t)-0930-(*)-ET(+)	19½	60	31½	84	43½	108	55½	132
9	36	AHF(t)-0936-(*)-ET(+)	19½	66	31½	90	43½	114	55½	138
9	42	AHF(t)-0942-(*)-ET(+)	19½	72	31½	96	43½	120	55½	144
6	9	AHF(t)-0609-(*)-ET(+)	18	39	30	63	42	87	54	111
6	12	AHF(t)-0612-(*)-ET(+)	18	42	30	66	42	90	54	114
6	18	AHF(t)-0618-(*)-ET(+)	18	48	30	72	42	96	54	120
6	24	AHF(t)-0624-(*)-ET(+)	18	54	30	78	42	102	54	126
6	30	AHF(t)-0630-(*)-ET(+)	18	60	30	84	42	108	54	132
6	36	AHF(t)-0636-(*)-ET(+)	18	66	30	90	42	114	54	138
6	42	AHF(t)-0642-(*)-ET(+)	18	72	30	96	42	120	54	144

(t) Insert side rail height. (*) Insert bottom style to complete cat. no. (+) Insert radius (12 in. – 48 in.). Includes 2 pairs of splice plates with hardware. T&B aluminum cable tray is composed of two distinct systems, H-style and U-style. These systems are interchangeable.

Part numbering system

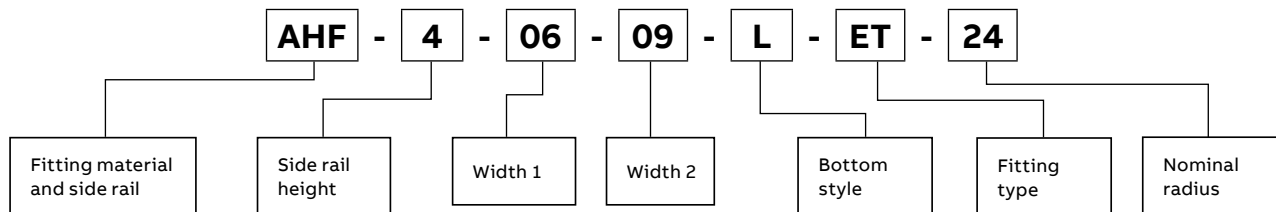

Aluminum fittings

U-style horizontal expanding cross fittings

Selection guide

- Tray widths W1: 36, 30, 24, 18, 12, 9, 6 in.
- Tray widths W2: 42, 36, 30, 24, 18, 12, 9 in.
- Nominal radius: 12, 24, 36, 48 in.
- Bottom styles: L– ladder, V– ventilated, S– solid
- Side rail heights: 4–7 in.

Horizontal expanding cross – U-style

Widths (in.)			Dimensions (in.)							
			(+ 12 in. Nominal radius		(+ 24 in. Nominal radius		(+ 36 in. Nominal radius		(+ 48 in. Nominal radius	
W1	W2	Cat. no.	X	Y	X	Y	X	Y	X	Y
36	42	AUF(t)-3642-(*)-EX(+)	60	66	84	90	108	114	132	138
30	36	AUF(t)-3036-(*)-EX(+)	54	60	78	84	102	108	126	132
30	42	AUF(t)-3042-(*)-EX(+)	54	66	78	90	102	114	126	138
24	30	AUF(t)-2430-(*)-EX(+)	48	54	72	78	96	102	120	126
24	36	AUF(t)-2436-(*)-EX(+)	48	60	72	84	96	108	120	132
24	42	AUF(t)-2442-(*)-EX(+)	48	66	72	90	96	114	120	138
18	24	AUF(t)-1824-(*)-EX(+)	42	48	66	72	90	96	114	120
18	30	AUF(t)-1830-(*)-EX(+)	42	54	66	78	90	102	114	126
18	36	AUF(t)-1836-(*)-EX(+)	42	60	66	84	90	108	114	132
18	42	AUF(t)-1842-(*)-EX(+)	42	66	66	90	90	114	114	138
12	18	AUF(t)-1218-(*)-EX(+)	36	42	60	66	84	90	108	114
12	24	AUF(t)-1224-(*)-EX(+)	36	48	60	72	84	96	108	120
12	30	AUF(t)-1230-(*)-EX(+)	36	54	60	78	84	102	108	126
12	36	AUF(t)-1236-(*)-EX(+)	36	60	60	84	84	108	108	132
12	42	AUF(t)-1242-(*)-EX(+)	36	66	60	90	84	114	108	138
9	12	AUF(t)-0912-(*)-EX(+)	33	36	57	60	81	84	105	108
9	18	AUF(t)-0918-(*)-EX(+)	33	42	57	66	81	90	105	114
9	24	AUF(t)-0924-(*)-EX(+)	33	48	57	72	81	96	105	120
9	30	AUF(t)-0930-(*)-EX(+)	33	54	57	78	81	102	105	126
9	36	AUF(t)-0936-(*)-EX(+)	33	60	57	84	81	108	105	132
9	42	AUF(t)-0942-(*)-EX(+)	33	66	57	90	81	114	105	138
6	9	AUF(t)-0609-(*)-EX(+)	30	33	54	57	78	81	102	105
6	12	AUF(t)-0612-(*)-EX(+)	30	36	54	60	78	84	102	108
6	18	AUF(t)-0618-(*)-EX(+)	30	42	54	66	78	90	102	114
6	24	AUF(t)-0624-(*)-EX(+)	30	48	54	72	78	96	102	120
6	30	AUF(t)-0630-(*)-EX(+)	30	54	54	78	78	102	102	126
6	36	AUF(t)-0636-(*)-EX(+)	30	60	54	84	78	108	102	132
6	42	AUF(t)-0642-(*)-EX(+)	30	66	54	90	78	114	102	138

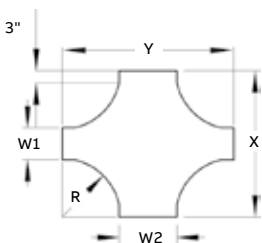
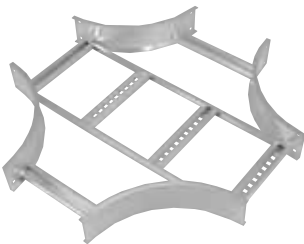

(t) Insert side rail height. (*) Insert bottom style to complete cat. no. (+) Insert radius (12 in. – 48 in.). Includes 3 pairs of splice plates with hardware. T&B aluminum cable tray is composed of two distinct systems H-style and U-style. These systems are interchangeable.

Part numbering system

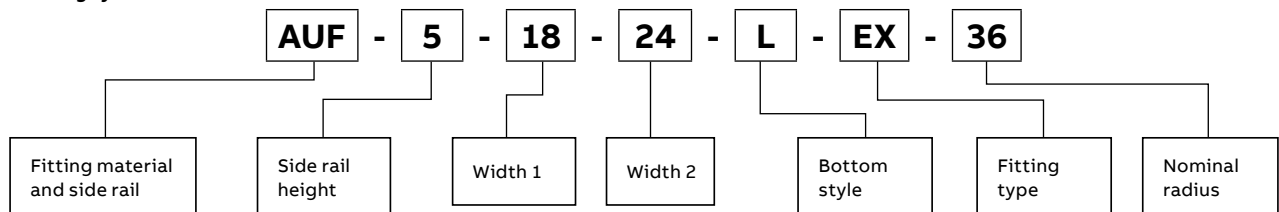

Aluminum fittings

H-style horizontal expanding cross fittings

Selection guide

- Tray widths W1: 36, 30, 24, 18, 12, 9, 6 in.
- Tray widths W2: 42, 36, 30, 24, 18, 12, 9 in.
- Nominal radius: 12, 24, 36, 48 in.
- Bottom styles: L- ladder, V- ventilated, S- solid
- Side rail heights: 4-7 in.

Horizontal expanding cross – H-style

Widths (in.)			Dimensions (in.)							
			(+ 12 in. Nominal radius		(+ 24 in. Nominal radius		(+ 36 in. Nominal radius		(+ 48 in. Nominal radius	
W1	W2	Cat. no.	X	Y	X	Y	X	Y	X	Y
36	42	AHF(+)-3642-(*)-EX(+)	66	72	90	96	114	120	138	144
30	36	AHF(+)-3036-(*)-EX(+)	60	66	84	90	108	114	132	138
30	42	AHF(+)-3042-(*)-EX(+)	60	72	84	96	108	120	132	144
24	30	AHF(+)-2430-(*)-EX(+)	54	60	78	84	102	108	126	132
24	36	AHF(+)-2436-(*)-EX(+)	54	66	78	90	102	114	126	138
24	42	AHF(+)-2442-(*)-EX(+)	54	75	78	96	102	120	126	144
18	24	AHF(+)-1824-(*)-EX(+)	48	54	72	78	96	102	120	126
18	30	AHF(+)-1830-(*)-EX(+)	48	60	72	84	96	108	120	132
18	36	AHF(+)-1836-(*)-EX(+)	48	66	72	90	96	114	120	138
18	42	AHF(+)-1842-(*)-EX(+)	48	72	72	96	96	120	120	144
12	18	AHF(+)-1218-(*)-EX(+)	42	48	66	72	90	96	114	120
12	24	AHF(+)-1224-(*)-EX(+)	42	54	66	78	90	102	114	126
12	30	AHF(+)-1230-(*)-EX(+)	42	60	66	84	90	108	114	132
12	36	AHF(+)-1236-(*)-EX(+)	42	66	66	90	90	114	114	138
12	42	AHF(+)-1242-(*)-EX(+)	42	72	66	96	90	120	114	144
9	12	AHF(+)-0912-(*)-EX(+)	39	42	63	66	87	90	111	114
9	18	AHF(+)-0918-(*)-EX(+)	39	48	63	72	87	96	111	120
9	24	AHF(+)-0924-(*)-EX(+)	39	54	63	78	87	102	111	126
9	30	AHF(+)-0930-(*)-EX(+)	39	60	63	84	87	108	111	132
9	36	AHF(+)-0936-(*)-EX(+)	39	66	63	90	87	114	111	138
9	42	AHF(+)-0942-(*)-EX(+)	39	72	63	96	87	120	111	144
6	9	AHF(+)-0609-(*)-EX(+)	36	39	60	63	84	87	108	111
6	12	AHF(+)-0612-(*)-EX(+)	36	42	60	66	84	90	108	114
6	18	AHF(+)-0618-(*)-EX(+)	36	48	60	72	84	96	108	120
6	24	AHF(+)-0624-(*)-EX(+)	36	54	60	78	84	102	108	126
6	30	AHF(+)-0630-(*)-EX(+)	36	60	60	84	84	108	108	132
6	36	AHF(+)-0636-(*)-EX(+)	36	66	60	90	84	114	108	138
6	42	AHF(+)-0642-(*)-EX(+)	36	72	60	96	84	120	108	144

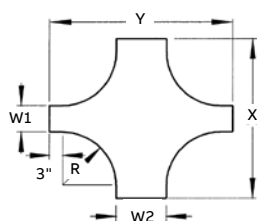
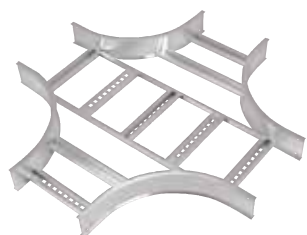

(†) Insert side rail height. (*) Insert bottom style to complete cat. no. (+) Insert radius (12 in. – 48 in.). Includes 3 pairs of splice plates with hardware. T&B aluminum cable tray is composed of two distinct systems, H-style and U-style. These systems are interchangeable.

Part numbering system

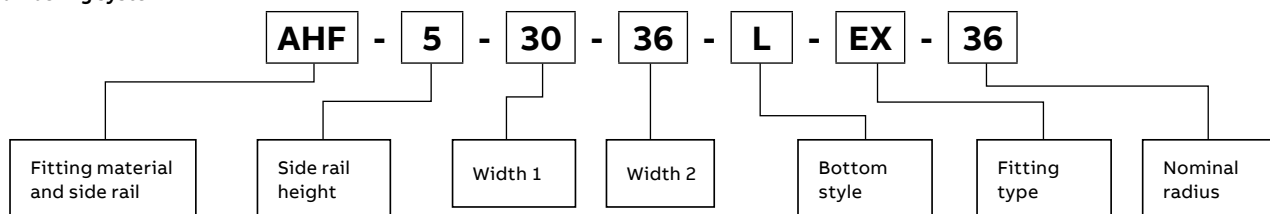

Aluminum fittings

U-style reducer fittings

Offset reducer – left



Reducer – straight



Offset reducer – right



Horizontal reducers – U-style

Widths (in.)

Widths (in.)		Left reducer	
W1	W2	Cat. no.	Dim. X (in.)
42	36	AUF(t)-42-36-(*)-HLR	15 ⁷ / ₁₆
42	30	AUF(t)-42-30-(*)-HLR	18 ¹⁵ / ₁₆
42	24	AUF(t)-42-24-(*)-HLR	22 ³ / ₈
42	18	AUF(t)-42-18-(*)-HLR	25 ⁷ / ₈
42	12	AUF(t)-42-12-(*)-HLR	29 ⁹ / ₁₆
42	9	AUF(t)-42-09-(*)-HLR	31 ¹ / ₂
42	6	AUF(t)-42-06-(*)-HLR	32 ³ / ₄
36	30	AUF(t)-36-30-(*)-HLR	15 ⁷ / ₁₆
36	24	AUF(t)-36-24-(*)-HLR	18 ¹⁵ / ₁₆
36	18	AUF(t)-36-18-(*)-HLR	22 ³ / ₈
36	12	AUF(t)-36-12-(*)-HLR	25 ⁷ / ₈
36	9	AUF(t)-36-09-(*)-HLR	27 ⁷ / ₁₆
36	6	AUF(t)-36-06-(*)-HLR	29 ⁹ / ₁₆

Straight reducer (concentric)

Straight reducer (concentric)	
Cat. no.	Dim. X (in.)
AUF(t)-42-36-(*)-HSR	13 ³ / ₄
AUF(t)-42-30-(*)-HSR	15 ⁷ / ₁₆
AUF(t)-42-24-(*)-HSR	17 ³ / ₁₆
AUF(t)-42-18-(*)-HSR	18 ⁵ / ₁₆
AUF(t)-42-12-(*)-HSR	20 ⁵ / ₈
AUF(t)-42-09-(*)-HSR	21 ¹ / ₂
AUF(t)-42-06-(*)-HSR	22 ³ / ₈
AUF(t)-36-30-(*)-HSR	13 ³ / ₄
AUF(t)-36-24-(*)-HSR	15 ⁷ / ₁₆
AUF(t)-36-18-(*)-HSR	17 ³ / ₈
AUF(t)-36-12-(*)-HSR	18 ⁵ / ₁₆
AUF(t)-36-09-(*)-HSR	19 ¹³ / ₁₆
AUF(t)-36-06-(*)-HSR	20 ¹¹ / ₁₆

Right reducer

Right reducer	
Cat. no.	Dim. X (in.)
AUF(t)-42-36-(*)-HRR	15 ⁷ / ₁₆
AUF(t)-42-30-(*)-HRR	18 ¹⁵ / ₁₆
AUF(t)-42-24-(*)-HRR	22 ³ / ₈
AUF(t)-42-18-(*)-HRR	25 ⁷ / ₈
AUF(t)-42-12-(*)-HRR	29 ⁹ / ₁₆
AUF(t)-42-09-(*)-HRR	31 ¹ / ₂
AUF(t)-42-06-(*)-HRR	32 ³ / ₄
AUF(t)-36-30-(*)-HRR	15 ⁷ / ₁₆
AUF(t)-36-24-(*)-HRR	18 ¹⁵ / ₁₆
AUF(t)-36-18-(*)-HRR	22 ³ / ₈
AUF(t)-36-12-(*)-HRR	25 ⁷ / ₈
AUF(t)-36-09-(*)-HRR	27 ⁷ / ₁₆
AUF(t)-36-06-(*)-HRR	29 ⁹ / ₁₆

Offset reducer – left

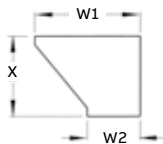

Reducer – straight

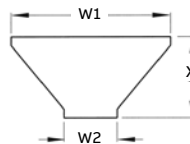

Offset reducer – right

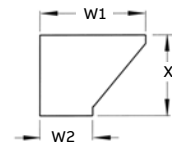

(t) Insert side rail height. (*) Insert bottom style to complete cat. no. Includes 1 pair of splice plates with hardware.
T&B aluminum cable tray is composed of two distinct systems, H-style and U-style. These systems are interchangeable.

Part numbering system

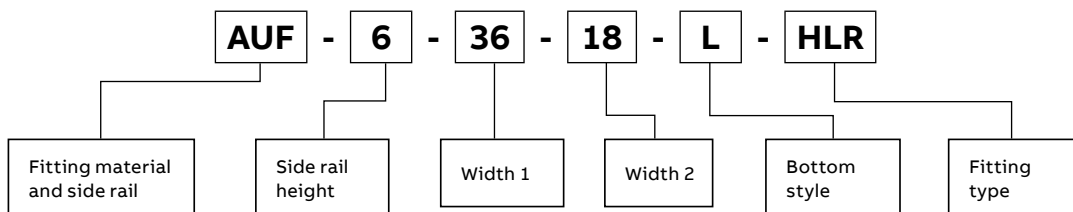

Offset reducer – left



Reducer – straight



Offset reducer – right



Horizontal reducers – U-style

Widths (in.)

Widths (in.)		Left reducer	Dim. X (in.)
W1	W2	Cat. no.	
30	24	AUF(t)-30-24-(*)-HLR	15 ⁷ / ₁₆
30	18	AUF(t)-30-18-(*)-HLR	18 ¹⁵ / ₁₆
30	12	AUF(t)-30-12-(*)-HLR	22 ³ / ₈
30	9	AUF(t)-30-09-(*)-HLR	24 ¹ / ₈
30	6	AUF(t)-30-06-(*)-HLR	25 ⁷ / ₈
24	18	AUF(t)-24-18-(*)-HLR	15 ⁷ / ₁₆
24	12	AUF(t)-24-12-(*)-HLR	18 ¹⁵ / ₁₆
24	9	AUF(t)-24-09-(*)-HLR	20 ¹¹ / ₁₆
24	6	AUF(t)-24-06-(*)-HLR	22 ³ / ₈
18	12	AUF(t)-18-12-(*)-HLR	15 ⁷ / ₁₆
18	9	AUF(t)-18-09-(*)-HLR	17 ³ / ₁₆
18	6	AUF(t)-18-06-(*)-HLR	18 ¹⁵ / ₁₆
12	9	AUF(t)-12-09-(*)-HLR	13 ³ / ₄
12	6	AUF(t)-12-06-(*)-HLR	15 ⁷ / ₁₆
9	6	AUF(t)-09-06-(*)-HLR	13 ³ / ₄

Straight reducer (concentric)

Cat. no.	Dim. X (in.)
AUF(t)-30-24-(*)-HSR	13 ³ / ₄
AUF(t)-30-18-(*)-HSR	15 ⁷ / ₁₆
AUF(t)-30-12-(*)-HSR	17 ³ / ₁₆
AUF(t)-30-09-(*)-HSR	18 ¹ / ₁₆
AUF(t)-30-06-(*)-HSR	18 ¹⁵ / ₁₆
AUF(t)-24-18-(*)-HSR	13 ³ / ₄
AUF(t)-24-12-(*)-HSR	15 ⁷ / ₁₆
AUF(t)-24-09-(*)-HSR	16 ⁵ / ₁₆
AUF(t)-24-06-(*)-HSR	17 ³ / ₁₆
AUF(t)-18-12-(*)-HSR	13 ³ / ₄
AUF(t)-18-09-(*)-HSR	14 ⁵ / ₈
AUF(t)-18-06-(*)-HSR	15 ⁷ / ₁₆
AUF(t)-12-09-(*)-HSR	12 ⁷ / ₈
AUF(t)-12-06-(*)-HSR	13 ³ / ₄
AUF(t)-09-06-(*)-HSR	12 ⁷ / ₈

Right reducer

Cat. no.	Dim. X (in.)
AUF(t)-30-24-(*)-HRR	15 ⁷ / ₁₆
AUF(t)-30-18-(*)-HRR	18 ¹⁵ / ₁₆
AUF(t)-30-12-(*)-HRR	22 ³ / ₈
AUF(t)-30-09-(*)-HRR	24 ¹ / ₈
AUF(t)-30-06-(*)-HRR	25 ⁷ / ₈
AUF(t)-24-18-(*)-HRR	15 ⁷ / ₁₆
AUF(t)-24-12-(*)-HRR	18 ¹⁵ / ₁₆
AUF(t)-24-09-(*)-HRR	20 ¹¹ / ₁₆
AUF(t)-24-06-(*)-HRR	22 ³ / ₈
AUF(t)-18-12-(*)-HRR	15 ⁷ / ₁₆
AUF(t)-18-09-(*)-HRR	17 ³ / ₁₆
AUF(t)-18-06-(*)-HRR	18 ¹⁵ / ₁₆
AUF(t)-12-09-(*)-HRR	13 ³ / ₄
AUF(t)-12-06-(*)-HRR	15 ⁷ / ₁₆
AUF(t)-09-06-(*)-HRR	13 ³ / ₄

Offset reducer – left

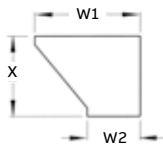

Reducer – straight

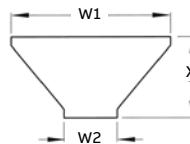

Offset reducer – right

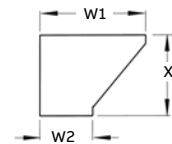

(t) Insert side rail height. (*) Insert bottom style to complete cat. no. Includes 1 pair of splice plates with hardware.
T&B aluminum cable tray is composed of two distinct systems, H-style and U-style. These systems are interchangeable.

Selection guide

- Tray widths W1: 42, 36, 30, 24, 18, 12, 9 in.
- Tray widths W2: 36, 30, 24, 18, 12, 9, 6 in.
- Bottom styles: L– ladder, V– ventilated, S– solid
- Side rail heights: 4–7 in.

Aluminum fittings

H-style reducer fittings

Offset reducer – left



Reducer – straight



Offset reducer – right



Horizontal reducers – H-style

Widths (in.)

Left reducer		Dim. X (in.)
W1	W2	Cat. no.
42	36	AHF(†)-42-36-(*)-HLR
	30	AHF(†)-42-30-(*)-HLR
	24	AHF(†)-42-24-(*)-HLR
	18	AHF(†)-42-18-(*)-HLR
	12	AHF(†)-42-12-(*)-HLR
	9	AHF(†)-42-09-(*)-HLR
	6	AHF(†)-42-06-(*)-HLR
36	30	AHF(†)-36-30-(*)-HLR
	24	AHF(†)-36-24-(*)-HLR
	18	AHF(†)-36-18-(*)-HLR
	12	AHF(†)-36-12-(*)-HLR
	9	AHF(†)-36-09-(*)-HLR
	6	AHF(†)-36-06-(*)-HLR
30	24	AHF(†)-30-24-(*)-HLR
	18	AHF(†)-30-18-(*)-HLR
	12	AHF(†)-30-12-(*)-HLR
	9	AHF(†)-30-09-(*)-HLR
	6	AHF(†)-30-06-(*)-HLR

Straight reducer (concentric)

Cat. no.	Dim. X (in.)
AHF(†)-42-36-(*)-HSR	13 ³ / ₁₆
AHF(†)-42-30-(*)-HSR	15 ⁷ / ₁₆
AHF(†)-42-24-(*)-HSR	17 ³ / ₁₆
AHF(†)-42-18-(*)-HSR	18 ⁵ / ₁₆
AHF(†)-42-12-(*)-HSR	20 ⁵ / ₁₆
AHF(†)-42-09-(*)-HSR	21 ¹ / ₂
AHF(†)-42-06-(*)-HSR	22 ³ / ₁₆
AHF(†)-36-30-(*)-HSR	13 ³ / ₁₆
AHF(†)-36-24-(*)-HSR	15 ⁷ / ₁₆
AHF(†)-36-18-(*)-HSR	17 ³ / ₁₆
AHF(†)-36-12-(*)-HSR	18 ⁵ / ₁₆
AHF(†)-36-09-(*)-HSR	19 ¹³ / ₁₆
AHF(†)-36-06-(*)-HSR	20 ¹¹ / ₁₆
AHF(†)-30-24-(*)-HSR	13 ³ / ₁₆
AHF(†)-30-18-(*)-HSR	15 ⁷ / ₁₆
AHF(†)-30-12-(*)-HSR	17 ³ / ₁₆
AHF(†)-30-09-(*)-HSR	18 ¹ / ₁₆
AHF(†)-30-06-(*)-HSR	18 ¹⁵ / ₁₆

Right reducer

Cat. no.	Dim. X (in.)
AHF(†)-42-36-(*)-HRR	15 ⁷ / ₁₆
AHF(†)-42-30-(*)-HRR	18 ¹⁵ / ₁₆
AHF(†)-42-24-(*)-HRR	22 ³ / ₁₆
AHF(†)-42-18-(*)-HRR	25 ³ / ₁₆
AHF(†)-42-12-(*)-HRR	29 ⁹ / ₁₆
AHF(†)-42-09-(*)-HRR	31 ¹ / ₁₆
AHF(†)-42-06-(*)-HRR	32 ³ / ₁₆
AHF(†)-36-30-(*)-HRR	15 ⁷ / ₁₆
AHF(†)-36-24-(*)-HRR	18 ¹⁵ / ₁₆
AHF(†)-36-18-(*)-HRR	22 ³ / ₁₆
AHF(†)-36-12-(*)-HRR	25 ³ / ₁₆
AHF(†)-36-09-(*)-HRR	27 ⁹ / ₁₆
AHF(†)-36-06-(*)-HRR	29 ⁹ / ₁₆
AHF(†)-30-24-(*)-HRR	15 ⁷ / ₁₆
AHF(†)-30-18-(*)-HRR	18 ¹⁵ / ₁₆
AHF(†)-30-12-(*)-HRR	22 ³ / ₁₆
AHF(†)-30-09-(*)-HRR	24 ³ / ₁₆
AHF(†)-30-06-(*)-HRR	25 ³ / ₁₆

Offset reducer – left

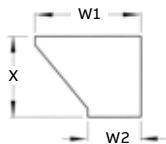

Reducer – straight

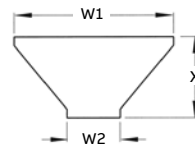

Offset reducer – right

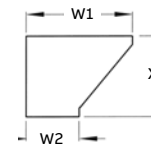

(†) Insert side rail height. (*) Insert bottom style to complete cat. no. Includes 1 pair of splice plates with hardware.
T&B aluminum cable tray is composed of two distinct systems, H-style and U-style. These systems are interchangeable.

Part numbering system

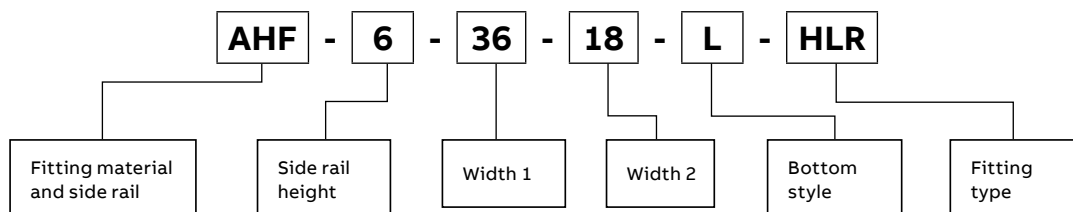

Offset reducer – left



Reducer – straight



Offset reducer – right



Horizontal reducers – H-style

Widths (in.)

Widths (in.)		Left reducer	Dim. X (in.)
W1	W2	Cat. no.	
24	18	AHF(†)-24-18-(*)-HLR	15 ⁷ / ₁₆
	12	AHF(†)-24-12-(*)-HLR	18 ¹⁵ / ₁₆
	9	AHF(†)-24-09-(*)-HLR	20 ¹¹ / ₁₆
	6	AHF(†)-24-06-(*)-HLR	22 ³ / ₁₆
18	12	AHF(†)-18-12-(*)-HLR	15 ⁷ / ₁₆
	9	AHF(†)-18-09-(*)-HLR	17 ³ / ₁₆
	6	AHF(†)-18-06-(*)-HLR	18 ¹⁵ / ₁₆
12	9	AHF(†)-12-09-(*)-HLR	13 ³ / ₄
	6	AHF(†)-12-06-(*)-HLR	15 ⁷ / ₁₆
9	6	AHF(†)-09-06-(*)-HLR	13 ³ / ₄

Straight reducer (concentric)

Straight reducer (concentric)	Dim. X (in.)
Cat. no.	
AHF(†)-24-18-(*)-HSR	13 ³ / ₄
AHF(†)-24-12-(*)-HSR	15 ⁷ / ₁₆
AHF(†)-24-09-(*)-HSR	16 ⁵ / ₁₆
AHF(†)-24-06-(*)-HSR	17 ³ / ₁₆
AHF(†)-18-12-(*)-HSR	13 ³ / ₄
AHF(†)-18-09-(*)-HSR	14 ⁵ / ₈
AHF(†)-18-06-(*)-HSR	15 ⁷ / ₁₆
AHF(†)-12-09-(*)-HSR	12 ⁷ / ₈
AHF(†)-12-06-(*)-HSR	13 ³ / ₄
AHF(†)-09-06-(*)-HSR	12 ⁷ / ₈

Right reducer

Right reducer	Dim. X (in.)
Cat. no.	
AHF(†)-24-18-(*)-HRR	15 ⁷ / ₁₆
AHF(†)-24-12-(*)-HRR	18 ¹⁵ / ₁₆
AHF(†)-24-09-(*)-HRR	20 ¹¹ / ₁₆
AHF(†)-24-06-(*)-HRR	22 ³ / ₁₆
AHF(†)-18-12-(*)-HRR	15 ⁷ / ₁₆
AHF(†)-18-09-(*)-HRR	17 ³ / ₁₆
AHF(†)-18-06-(*)-HRR	18 ¹⁵ / ₁₆
AHF(†)-12-09-(*)-HRR	13 ³ / ₄
AHF(†)-12-06-(*)-HRR	15 ⁷ / ₁₆
AHF(†)-09-06-(*)-HRR	13 ³ / ₄

Offset reducer – left

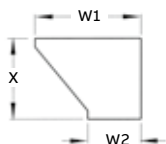

Reducer – straight

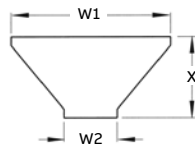

Offset reducer – right

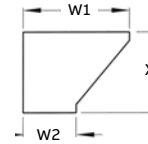

(†) Insert side rail height. (*) Insert bottom style to complete cat. no. Includes 1 pair of splice plates with hardware.
 T&B aluminum cable tray is composed of two distinct systems, H-style and U-style. These systems are interchangeable.

Selection guide

- Tray widths W1: 42, 36, 30, 24, 18, 12, 9 in.
- Tray widths W2: 36, 30, 24, 18, 12, 9, 6 in.
- Bottom styles: L– ladder, V– ventilated, S– solid
- Side rail heights: 4–7 in.

Aluminum fittings

45° U-style horizontal wye fittings

Left-hand wye

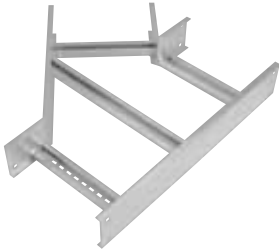

Right-hand wye



Selection guide

- Inside tray widths: 6, 9, 12, 18, 24, 30, 36, 42 in.
- Bottom styles: L– ladder, V– ventilated, S– solid
- Side rail heights: 4–7 in.

45° Horizontal wye – U-style

Width (in.)	Left-hand wye Cat. no.	Right-hand wye Cat. no.	Dimensions (in.)		
			X	Y	Z
6	AUF(t)-06-(*)-HYL	AUF(t)-06-(*)-HYR	18 ³ / ₁₆	14 ¹³ / ₁₆	12 ⁷ / ₁₆
9	AUF(t)-09-(*)-HYL	AUF(t)-09-(*)-HYR	22 ¹ / ₂	19 ¹⁵ / ₁₆	15 ⁷ / ₁₆
12	AUF(t)-12-(*)-HYL	AUF(t)-12-(*)-HYR	26 ³ / ₄	25	18 ⁷ / ₁₆
18	AUF(t)-18-(*)-HYL	AUF(t)-18-(*)-HYR	35 ³ / ₄	35 ³ / ₄	24 ⁷ / ₁₆
24	AUF(t)-24-(*)-HYL	AUF(t)-24-(*)-HYR	43 ¹ / ₂	45 ¹ / ₂	30 ⁷ / ₁₆
30	AUF(t)-30-(*)-HYL	AUF(t)-30-(*)-HYR	52 ¹ / ₄	55 ³ / ₄	36 ⁷ / ₁₆
36	AUF(t)-36-(*)-HYL	AUF(t)-36-(*)-HYR	60 ¹¹ / ₁₆	66	42 ⁷ / ₁₆
42	AUF(t)-42-(*)-HYL	AUF(t)-42-(*)-HYR	69 ³ / ₁₆	76 ³ / ₄	45 ⁷ / ₁₆

Left-hand wye

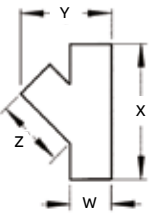

Right-hand wye

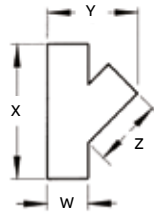

(t) Insert side rail height. (*) Insert bottom style to complete cat. no. Includes 2 pairs of splice plates with hardware.
 T&B aluminum cable tray is composed of two distinct systems, H-style and U-style. These systems are interchangeable.

Part numbering system

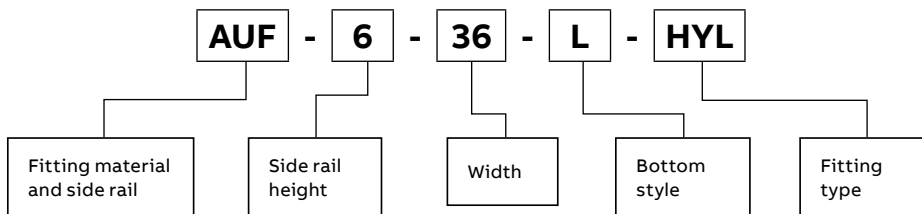

Aluminum fittings

45° H-style horizontal wye fittings

Left-hand wye

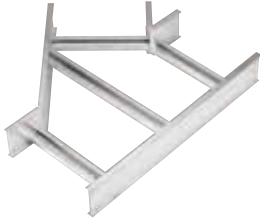

Right-hand wye

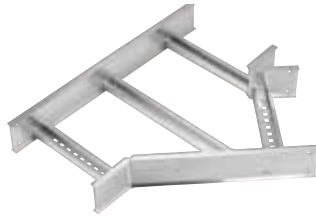

Selection guide

- Inside tray widths: 6, 9, 12, 18, 24, 30, 36, 42 in.
- Bottom styles: L– ladder, V– ventilated, S– solid
- Side rail heights: 4–7 in.

45° Horizontal wye – H-style

Width (in.)	Left-hand wye Cat. no.	Right-hand wye Cat. no.	Dimensions (in.)		
			X	Y	Z
6	AHF(†)-06-(*)-HYL	AHF(†)-06-(*)-HYR	18 ⁵ / ₁₆	14 ¹³ / ₁₆	12 ⁷ / ₁₆
9	AHF(†)-09-(*)-HYL	AHF(†)-09-(*)-HYR	22 ¹ / ₂	19 ¹⁵ / ₁₆	15 ⁷ / ₁₆
12	AHF(†)-12-(*)-HYL	AHF(†)-12-(*)-HYR	26 ³ / ₄	25	18 ⁷ / ₁₆
18	AHF(†)-18-(*)-HYL	AHF(†)-18-(*)-HYR	35 ³ / ₄	35 ³ / ₄	24 ⁷ / ₁₆
24	AHF(†)-24-(*)-HYL	AHF(†)-24-(*)-HYR	43 ¹ / ₂	45 ¹ / ₂	30 ⁷ / ₁₆
30	AHF(†)-30-(*)-HYL	AHF(†)-30-(*)-HYR	52 ¹ / ₄	55 ³ / ₄	36 ⁷ / ₁₆
36	AHF(†)-36-(*)-HYL	AHF(†)-36-(*)-HYR	60 ¹¹ / ₁₆	66	42 ⁷ / ₁₆
42	AHF(†)-42-(*)-HYL	AHF(†)-42-(*)-HYR	69 ³ / ₁₆	76 ³ / ₄	45 ⁷ / ₁₆

Left hand wye

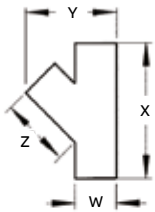

Right hand wye

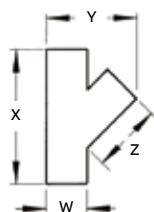

(†) Insert side rail height. (*) Insert bottom style to complete cat. no. Includes 2 pairs of splice plates with hardware.
 T&B aluminum cable tray is composed of two distinct systems, H-style and U-style. These systems are interchangeable.

Part numbering system

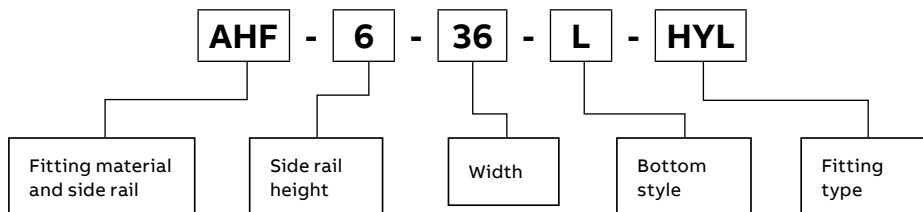



Aluminum fittings

90° U-style vertical bend fittings

Selection guide

- Inside tray widths: 6, 9, 12, 18, 24, 30, 36, 42 in.
- Angle: 90°
- Radius: 12, 24, 36, 48 in.
- Bottom styles: L- ladder, V- ventilated, S- solid
- Side rail heights: 4-7 in.

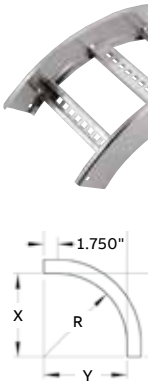
90° Vertical bend – U-style

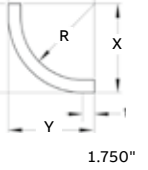
	Nominal		Cat. no.	(+ VO side rail				(+ VI side rail						
	Radius (in.)	Width (in.)		4 in. – 7 in.		4 in.		5 in.		6 in.		7 in.		
				X	Y	X	Y	X	Y	X	Y	X	Y	
 <p>Outside bend</p>	12	6	AUF(+)-06-(*)-(+)90-12	12	12	17 ¹⁵ / ₁₆	17 ¹⁵ / ₁₆	18 ¹³ / ₁₆	18 ¹³ / ₁₆	20	20	21	21	
	12	9	AUF(+)-09-(*)-(+)90-12	12	12	17 ¹⁵ / ₁₆	17 ¹⁵ / ₁₆	18 ¹³ / ₁₆	18 ¹³ / ₁₆	20	20	21	21	
	12	12	AUF(+)-12-(*)-(+)90-12	12	12	17 ¹⁵ / ₁₆	17 ¹⁵ / ₁₆	18 ¹³ / ₁₆	18 ¹³ / ₁₆	20	20	21	21	
	12	18	AUF(+)-18-(*)-(+)90-12	12	12	17 ¹⁵ / ₁₆	17 ¹⁵ / ₁₆	18 ¹³ / ₁₆	18 ¹³ / ₁₆	20	20	21	21	
	12	24	AUF(+)-24-(*)-(+)90-12	12	12	17 ¹⁵ / ₁₆	17 ¹⁵ / ₁₆	18 ¹³ / ₁₆	18 ¹³ / ₁₆	20	20	21	21	
	12	30	AUF(+)-30-(*)-(+)90-12	12	12	17 ¹⁵ / ₁₆	17 ¹⁵ / ₁₆	18 ¹³ / ₁₆	18 ¹³ / ₁₆	20	20	21	21	
	12	36	AUF(+)-36-(*)-(+)90-12	12	12	17 ¹⁵ / ₁₆	17 ¹⁵ / ₁₆	18 ¹³ / ₁₆	18 ¹³ / ₁₆	20	20	21	21	
	12	42	AUF(+)-42-(*)-(+)90-12	12	12	17 ¹⁵ / ₁₆	17 ¹⁵ / ₁₆	18 ¹³ / ₁₆	18 ¹³ / ₁₆	20	20	21	21	
	 <p>Inside bend</p>	24	6	AUF(+)-06-(*)-(+)90-24	24	24	29 ¹⁵ / ₁₆	29 ¹⁵ / ₁₆	30 ¹³ / ₁₆	30 ¹³ / ₁₆	32	32	33	33
		24	9	AUF(+)-09-(*)-(+)90-24	24	24	29 ¹⁵ / ₁₆	29 ¹⁵ / ₁₆	30 ¹³ / ₁₆	30 ¹³ / ₁₆	32	32	33	33
		24	12	AUF(+)-12-(*)-(+)90-24	24	24	29 ¹⁵ / ₁₆	29 ¹⁵ / ₁₆	30 ¹³ / ₁₆	30 ¹³ / ₁₆	32	32	33	33
		24	18	AUF(+)-18-(*)-(+)90-24	24	24	29 ¹⁵ / ₁₆	29 ¹⁵ / ₁₆	30 ¹³ / ₁₆	30 ¹³ / ₁₆	32	32	33	33
24		24	AUF(+)-24-(*)-(+)90-24	24	24	29 ¹⁵ / ₁₆	29 ¹⁵ / ₁₆	30 ¹³ / ₁₆	30 ¹³ / ₁₆	32	32	33	33	
24		30	AUF(+)-30-(*)-(+)90-24	24	24	29 ¹⁵ / ₁₆	29 ¹⁵ / ₁₆	30 ¹³ / ₁₆	30 ¹³ / ₁₆	32	32	33	33	
24		36	AUF(+)-36-(*)-(+)90-24	24	24	29 ¹⁵ / ₁₆	29 ¹⁵ / ₁₆	30 ¹³ / ₁₆	30 ¹³ / ₁₆	32	32	33	33	
24		42	AUF(+)-42-(*)-(+)90-24	24	24	29 ¹⁵ / ₁₆	29 ¹⁵ / ₁₆	30 ¹³ / ₁₆	30 ¹³ / ₁₆	32	32	33	33	
36		6	AUF(+)-06-(*)-(+)90-36	36	36	41 ¹⁵ / ₁₆	41 ¹⁵ / ₁₆	42 ¹³ / ₁₆	42 ¹³ / ₁₆	44	44	44	44	
36		9	AUF(+)-09-(*)-(+)90-36	36	36	41 ¹⁵ / ₁₆	41 ¹⁵ / ₁₆	42 ¹³ / ₁₆	42 ¹³ / ₁₆	44	44	44	44	
36		12	AUF(+)-12-(*)-(+)90-36	36	36	41 ¹⁵ / ₁₆	41 ¹⁵ / ₁₆	42 ¹³ / ₁₆	42 ¹³ / ₁₆	44	44	44	44	
36		18	AUF(+)-18-(*)-(+)90-36	36	36	41 ¹⁵ / ₁₆	41 ¹⁵ / ₁₆	42 ¹³ / ₁₆	42 ¹³ / ₁₆	44	44	44	44	
36	24	AUF(+)-24-(*)-(+)90-36	36	36	41 ¹⁵ / ₁₆	41 ¹⁵ / ₁₆	42 ¹³ / ₁₆	42 ¹³ / ₁₆	44	44	44	44		
36	30	AUF(+)-30-(*)-(+)90-36	36	36	41 ¹⁵ / ₁₆	41 ¹⁵ / ₁₆	42 ¹³ / ₁₆	42 ¹³ / ₁₆	44	44	44	44		
36	36	AUF(+)-36-(*)-(+)90-36	36	36	41 ¹⁵ / ₁₆	41 ¹⁵ / ₁₆	42 ¹³ / ₁₆	42 ¹³ / ₁₆	44	44	44	44		
36	42	AUF(+)-42-(*)-(+)90-36	36	36	41 ¹⁵ / ₁₆	41 ¹⁵ / ₁₆	42 ¹³ / ₁₆	42 ¹³ / ₁₆	44	44	44	44		
 <p>Outside bend</p>	48	6	AUF(+)-06-(*)-(+)90-48	48	48	53 ¹⁵ / ₁₆	53 ¹⁵ / ₁₆	54 ¹³ / ₁₆	54 ¹³ / ₁₆	56	56	57	57	
	48	9	AUF(+)-09-(*)-(+)90-48	48	48	53 ¹⁵ / ₁₆	53 ¹⁵ / ₁₆	54 ¹³ / ₁₆	54 ¹³ / ₁₆	56	56	57	57	
	48	12	AUF(+)-12-(*)-(+)90-48	48	48	53 ¹⁵ / ₁₆	53 ¹⁵ / ₁₆	54 ¹³ / ₁₆	54 ¹³ / ₁₆	56	56	57	57	
	48	18	AUF(+)-18-(*)-(+)90-48	48	48	53 ¹⁵ / ₁₆	53 ¹⁵ / ₁₆	54 ¹³ / ₁₆	54 ¹³ / ₁₆	56	56	57	57	
	48	24	AUF(+)-24-(*)-(+)90-48	48	48	53 ¹⁵ / ₁₆	53 ¹⁵ / ₁₆	54 ¹³ / ₁₆	54 ¹³ / ₁₆	56	56	57	57	
	48	30	AUF(+)-30-(*)-(+)90-48	48	48	53 ¹⁵ / ₁₆	53 ¹⁵ / ₁₆	54 ¹³ / ₁₆	54 ¹³ / ₁₆	56	56	57	57	
	48	36	AUF(+)-36-(*)-(+)90-48	48	48	53 ¹⁵ / ₁₆	53 ¹⁵ / ₁₆	54 ¹³ / ₁₆	54 ¹³ / ₁₆	56	56	57	57	
	48	42	AUF(+)-42-(*)-(+)90-48	48	48	53 ¹⁵ / ₁₆	53 ¹⁵ / ₁₆	54 ¹³ / ₁₆	54 ¹³ / ₁₆	56	56	57	57	

(†) Insert side rail height. (*) Insert bottom style (+) Insert “VO” for vertical outside or “VI” for vertical inside to complete cat. no. Includes 1 pair of splice plates with hardware. T&B aluminum cable tray is composed of two distinct systems, H-style and U-style. These systems are interchangeable.

Part numbering system

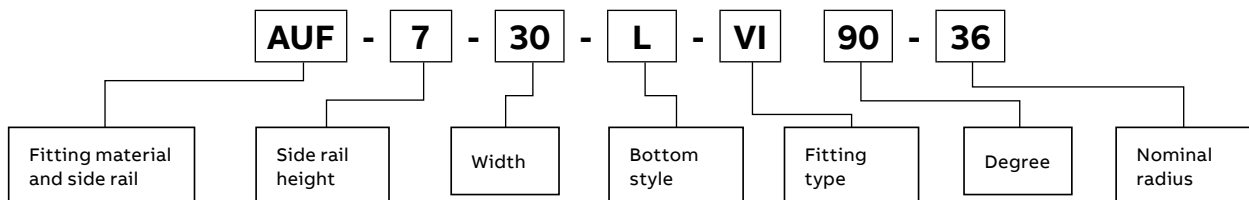

Aluminum fittings

90° H-style vertical bend fittings

Selection guide

- Inside tray widths: 6, 9, 12, 18, 24, 30, 36, 42 in.
- Angle: 90°
- Radius: 12, 24, 36, 48 in.
- Bottom styles: L- ladder, V- ventilated, S- solid
- Side rail heights: 4-7 in.

90° Vertical bend – H-style

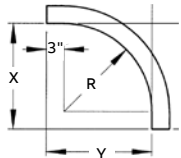
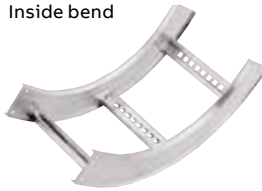
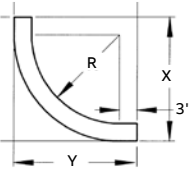
	Nominal			Dimensions (in.)									
				(+ VO side rail					(+ VI side rail				
				4 in. – 7 in.		4 in.		5 in.		6 in.		7 in.	
Radius (in.)	Width (in.)	Cat. no.	X	Y	X	Y	X	Y	X	Y	X	Y	
Outside bend  	12	6	AHF(+)-06-(*)-(+)90-12	15	15	19 ³ / ₁₆	19 ³ / ₁₆	20 ¹ / ₁₆	20 ¹ / ₁₆	21 ¹ / ₄	21 ¹ / ₄	22 ³ / ₄	22 ³ / ₄
	12	9	AHF(+)-09-(*)-(+)90-12	15	15	19 ³ / ₁₆	19 ³ / ₁₆	20 ¹ / ₁₆	20 ¹ / ₁₆	21 ¹ / ₄	21 ¹ / ₄	22 ³ / ₄	22 ³ / ₄
	12	12	AHF(+)-12-(*)-(+)90-12	15	15	19 ³ / ₁₆	19 ³ / ₁₆	20 ¹ / ₁₆	20 ¹ / ₁₆	21 ¹ / ₄	21 ¹ / ₄	22 ³ / ₄	22 ³ / ₄
	12	18	AHF(+)-18-(*)-(+)90-12	15	15	19 ³ / ₁₆	19 ³ / ₁₆	20 ¹ / ₁₆	20 ¹ / ₁₆	21 ¹ / ₄	21 ¹ / ₄	22 ³ / ₄	22 ³ / ₄
	12	24	AHF(+)-24-(*)-(+)90-12	15	15	19 ³ / ₁₆	19 ³ / ₁₆	20 ¹ / ₁₆	20 ¹ / ₁₆	21 ¹ / ₄	21 ¹ / ₄	22 ³ / ₄	22 ³ / ₄
	12	30	AHF(+)-30-(*)-(+)90-12	15	15	19 ³ / ₁₆	19 ³ / ₁₆	20 ¹ / ₁₆	20 ¹ / ₁₆	21 ¹ / ₄	21 ¹ / ₄	22 ³ / ₄	22 ³ / ₄
	12	36	AHF(+)-36-(*)-(+)90-12	15	15	19 ³ / ₁₆	19 ³ / ₁₆	20 ¹ / ₁₆	20 ¹ / ₁₆	21 ¹ / ₄	21 ¹ / ₄	22 ³ / ₄	22 ³ / ₄
	12	42	AHF(+)-42-(*)-(+)90-12	15	15	19 ³ / ₁₆	19 ³ / ₁₆	20 ¹ / ₁₆	20 ¹ / ₁₆	21 ¹ / ₄	21 ¹ / ₄	22 ³ / ₄	22 ³ / ₄
	24	6	AHF(+)-06-(*)-(+)90-24	27	27	31 ³ / ₁₆	31 ³ / ₁₆	32 ¹ / ₁₆	32 ¹ / ₁₆	33 ³ / ₄	33 ³ / ₄	34 ³ / ₄	34 ³ / ₄
	24	9	AHF(+)-09-(*)-(+)90-24	27	27	31 ³ / ₁₆	31 ³ / ₁₆	32 ¹ / ₁₆	32 ¹ / ₁₆	33 ³ / ₄	33 ³ / ₄	34 ³ / ₄	34 ³ / ₄
	24	12	AHF(+)-12-(*)-(+)90-24	27	27	31 ³ / ₁₆	31 ³ / ₁₆	32 ¹ / ₁₆	32 ¹ / ₁₆	33 ³ / ₄	33 ³ / ₄	34 ³ / ₄	34 ³ / ₄
	24	18	AHF(+)-18-(*)-(+)90-24	27	27	31 ³ / ₁₆	31 ³ / ₁₆	32 ¹ / ₁₆	32 ¹ / ₁₆	33 ³ / ₄	33 ³ / ₄	34 ³ / ₄	34 ³ / ₄
24	24	AHF(+)-24-(*)-(+)90-24	27	27	31 ³ / ₁₆	31 ³ / ₁₆	32 ¹ / ₁₆	32 ¹ / ₁₆	33 ³ / ₄	33 ³ / ₄	34 ³ / ₄	34 ³ / ₄	
24	30	AHF(+)-30-(*)-(+)90-24	27	27	31 ³ / ₁₆	31 ³ / ₁₆	32 ¹ / ₁₆	32 ¹ / ₁₆	33 ³ / ₄	33 ³ / ₄	34 ³ / ₄	34 ³ / ₄	
24	36	AHF(+)-36-(*)-(+)90-24	27	27	31 ³ / ₁₆	31 ³ / ₁₆	32 ¹ / ₁₆	32 ¹ / ₁₆	33 ³ / ₄	33 ³ / ₄	34 ³ / ₄	34 ³ / ₄	
24	42	AHF(+)-42-(*)-(+)90-24	27	27	31 ³ / ₁₆	31 ³ / ₁₆	32 ¹ / ₁₆	32 ¹ / ₁₆	33 ³ / ₄	33 ³ / ₄	34 ³ / ₄	34 ³ / ₄	
Inside bend  	36	6	AHF(+)-06-(*)-(+)90-36	39	39	43 ³ / ₁₆	43 ³ / ₁₆	44 ¹ / ₁₆	44 ¹ / ₁₆	45 ³ / ₄	45 ³ / ₄	46 ³ / ₄	46 ³ / ₄
	36	9	AHF(+)-09-(*)-(+)90-36	39	39	43 ³ / ₁₆	43 ³ / ₁₆	44 ¹ / ₁₆	44 ¹ / ₁₆	45 ³ / ₄	45 ³ / ₄	46 ³ / ₄	46 ³ / ₄
	36	12	AHF(+)-12-(*)-(+)90-36	39	39	43 ³ / ₁₆	43 ³ / ₁₆	44 ¹ / ₁₆	44 ¹ / ₁₆	45 ³ / ₄	45 ³ / ₄	46 ³ / ₄	46 ³ / ₄
	36	18	AHF(+)-18-(*)-(+)90-36	39	39	43 ³ / ₁₆	43 ³ / ₁₆	44 ¹ / ₁₆	44 ¹ / ₁₆	45 ³ / ₄	45 ³ / ₄	46 ³ / ₄	46 ³ / ₄
	36	24	AHF(+)-24-(*)-(+)90-36	39	39	43 ³ / ₁₆	43 ³ / ₁₆	44 ¹ / ₁₆	44 ¹ / ₁₆	45 ³ / ₄	45 ³ / ₄	46 ³ / ₄	46 ³ / ₄
	36	30	AHF(+)-30-(*)-(+)90-36	39	39	43 ³ / ₁₆	43 ³ / ₁₆	44 ¹ / ₁₆	44 ¹ / ₁₆	45 ³ / ₄	45 ³ / ₄	46 ³ / ₄	46 ³ / ₄
	36	36	AHF(+)-36-(*)-(+)90-36	39	39	43 ³ / ₁₆	43 ³ / ₁₆	44 ¹ / ₁₆	44 ¹ / ₁₆	45 ³ / ₄	45 ³ / ₄	46 ³ / ₄	46 ³ / ₄
	36	42	AHF(+)-42-(*)-(+)90-36	39	39	43 ³ / ₁₆	43 ³ / ₁₆	44 ¹ / ₁₆	44 ¹ / ₁₆	45 ³ / ₄	45 ³ / ₄	46 ³ / ₄	46 ³ / ₄
	48	6	AHF(+)-06-(*)-(+)90-48	51	51	55 ³ / ₁₆	55 ³ / ₁₆	56 ¹ / ₁₆	56 ¹ / ₁₆	57 ³ / ₄	57 ³ / ₄	58 ³ / ₄	58 ³ / ₄
	48	9	AHF(+)-09-(*)-(+)90-48	51	51	55 ³ / ₁₆	55 ³ / ₁₆	56 ¹ / ₁₆	56 ¹ / ₁₆	57 ³ / ₄	57 ³ / ₄	58 ³ / ₄	58 ³ / ₄
	48	12	AHF(+)-12-(*)-(+)90-48	51	51	55 ³ / ₁₆	55 ³ / ₁₆	56 ¹ / ₁₆	56 ¹ / ₁₆	57 ³ / ₄	57 ³ / ₄	58 ³ / ₄	58 ³ / ₄
	48	18	AHF(+)-18-(*)-(+)90-48	51	51	55 ³ / ₁₆	55 ³ / ₁₆	56 ¹ / ₁₆	56 ¹ / ₁₆	57 ³ / ₄	57 ³ / ₄	58 ³ / ₄	58 ³ / ₄
48	24	AHF(+)-24-(*)-(+)90-48	51	51	55 ³ / ₁₆	55 ³ / ₁₆	56 ¹ / ₁₆	56 ¹ / ₁₆	57 ³ / ₄	57 ³ / ₄	58 ³ / ₄	58 ³ / ₄	
48	30	AHF(+)-30-(*)-(+)90-48	51	51	55 ³ / ₁₆	55 ³ / ₁₆	56 ¹ / ₁₆	56 ¹ / ₁₆	57 ³ / ₄	57 ³ / ₄	58 ³ / ₄	58 ³ / ₄	
48	36	AHF(+)-36-(*)-(+)90-48	51	51	55 ³ / ₁₆	55 ³ / ₁₆	56 ¹ / ₁₆	56 ¹ / ₁₆	57 ³ / ₄	57 ³ / ₄	58 ³ / ₄	58 ³ / ₄	
48	42	AHF(+)-42-(*)-(+)90-48	51	51	55 ³ / ₁₆	55 ³ / ₁₆	56 ¹ / ₁₆	56 ¹ / ₁₆	57 ³ / ₄	57 ³ / ₄	58 ³ / ₄	58 ³ / ₄	

(†) Insert side rail height. (*) Insert bottom style (+) Insert "VO" for vertical outside or "VI" for vertical inside to complete cat. no. Includes 1 pair of splice plates with hardware. T&B aluminum cable tray is composed of two distinct systems, H-style and U-style. These systems are interchangeable.

Part numbering system

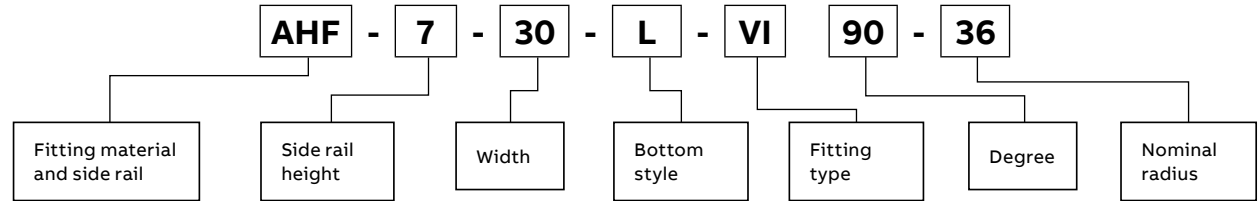

Aluminum fittings

60° U-style vertical bend fittings

Selection guide

- Inside tray widths: 6, 9, 12, 18, 24, 30, 36, 42 in.
- Angle: 60°
- Radius: 12, 24, 36, 48 in.
- Bottom styles: L- ladder, V- ventilated, S- solid
- Side rail heights: 4-7 in.

60° Vertical bend – U-style

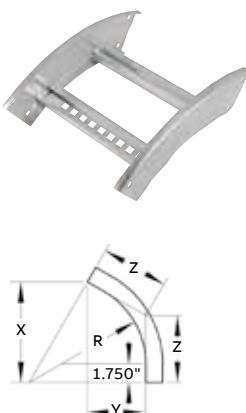
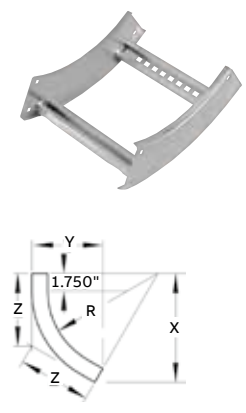
	Nominal		Cat. no.	Dimensions (in.)															
				(+ VO side rail						(+ VI side rail									
				4 in. – 7 in.			4 in.			5 in.			6 in.			7 in.			
Radius	Width		X	Y	Z	X	Y	Z	X	Y	Z	X	Y	Z					
 <p>Outside bend</p>	12	6	AUF(+)-06-(*)-(+)60-12	13	7½	8 ¹¹ / ₁₆	16 ⁵ / ₈	11 ¹¹ / ₁₆	11 ¹ / ₁₆	17 ⁷ / ₁₆	12 ⁵ / ₈	11 ⁵ / ₈	18 ³ / ₄	13 ¹¹ / ₁₆	12¼	19 ⁵ / ₁₆	14¾	12 ⁷ / ₈	
	12	9	AUF(+)-09-(*)-(+)60-12	13	7½	8 ¹¹ / ₁₆	16 ⁵ / ₈	11 ¹¹ / ₁₆	11 ¹ / ₁₆	17 ⁷ / ₁₆	12 ⁵ / ₈	11 ⁵ / ₈	18 ³ / ₄	13 ¹¹ / ₁₆	12¼	19 ⁵ / ₁₆	14¾	12 ⁷ / ₈	
	12	12	AUF(+)-12-(*)-(+)60-12	13	7½	8 ¹¹ / ₁₆	16 ⁵ / ₈	11 ¹¹ / ₁₆	11 ¹ / ₁₆	17 ⁷ / ₁₆	12 ⁵ / ₈	11 ⁵ / ₈	18 ³ / ₄	13 ¹¹ / ₁₆	12¼	19 ⁵ / ₁₆	14¾	12 ⁷ / ₈	
	12	18	AUF(+)-18-(*)-(+)60-12	13	7½	8 ¹¹ / ₁₆	16 ⁵ / ₈	11 ¹¹ / ₁₆	11 ¹ / ₁₆	17 ⁷ / ₁₆	12 ⁵ / ₈	11 ⁵ / ₈	18 ³ / ₄	13 ¹¹ / ₁₆	12¼	19 ⁵ / ₁₆	14¾	12 ⁷ / ₈	
	12	24	AUF(+)-24-(*)-(+)60-12	13	7½	8 ¹¹ / ₁₆	16 ⁵ / ₈	11 ¹¹ / ₁₆	11 ¹ / ₁₆	17 ⁷ / ₁₆	12 ⁵ / ₈	11 ⁵ / ₈	18 ³ / ₄	13 ¹¹ / ₁₆	12¼	19 ⁵ / ₁₆	14¾	12 ⁷ / ₈	
	12	30	AUF(+)-30-(*)-(+)60-12	13	7½	8 ¹¹ / ₁₆	16 ⁵ / ₈	11 ¹¹ / ₁₆	11 ¹ / ₁₆	17 ⁷ / ₁₆	12 ⁵ / ₈	11 ⁵ / ₈	18 ³ / ₄	13 ¹¹ / ₁₆	12¼	19 ⁵ / ₁₆	14¾	12 ⁷ / ₈	
	12	36	AUF(+)-36-(*)-(+)60-12	13	7½	8 ¹¹ / ₁₆	16 ⁵ / ₈	11 ¹¹ / ₁₆	11 ¹ / ₁₆	17 ⁷ / ₁₆	12 ⁵ / ₈	11 ⁵ / ₈	18 ³ / ₄	13 ¹¹ / ₁₆	12¼	19 ⁵ / ₁₆	14¾	12 ⁷ / ₈	
	12	42	AUF(+)-42-(*)-(+)60-12	13	7½	8 ¹¹ / ₁₆	16 ⁵ / ₈	11 ¹¹ / ₁₆	11 ¹ / ₁₆	17 ⁷ / ₁₆	12 ⁵ / ₈	11 ⁵ / ₈	18 ³ / ₄	13 ¹¹ / ₁₆	12¼	19 ⁵ / ₁₆	14¾	12 ⁷ / ₈	
	24	6	AUF(+)-06-(*)-(+)60-24	23 ⁷ / ₁₆	13½	15 ⁵ / ₈	27	17 ¹³ / ₁₆	18	27 ¹³ / ₁₆	18 ⁵ / ₈	16 ⁵ / ₁₆	28¾	19 ¹¹ / ₁₆	19 ³ / ₁₆	29 ¹¹ / ₁₆	20¾	19 ¹³ / ₁₆	
	24	9	AUF(+)-09-(*)-(+)60-24	23 ⁷ / ₁₆	13½	15 ⁵ / ₈	27	17 ¹³ / ₁₆	18	27 ¹³ / ₁₆	18 ⁵ / ₈	16 ⁵ / ₁₆	28¾	19 ¹¹ / ₁₆	19 ³ / ₁₆	29 ¹¹ / ₁₆	20¾	19 ¹³ / ₁₆	
	24	12	AUF(+)-12-(*)-(+)60-24	23 ⁷ / ₁₆	13½	15 ⁵ / ₈	27	17 ¹³ / ₁₆	18	27 ¹³ / ₁₆	18 ⁵ / ₈	16 ⁵ / ₁₆	28¾	19 ¹¹ / ₁₆	19 ³ / ₁₆	29 ¹¹ / ₁₆	20¾	19 ¹³ / ₁₆	
	24	18	AUF(+)-18-(*)-(+)60-24	23 ⁷ / ₁₆	13½	15 ⁵ / ₈	27	17 ¹³ / ₁₆	18	27 ¹³ / ₁₆	18 ⁵ / ₈	16 ⁵ / ₁₆	28¾	19 ¹¹ / ₁₆	19 ³ / ₁₆	29 ¹¹ / ₁₆	20¾	19 ¹³ / ₁₆	
	24	24	AUF(+)-24-(*)-(+)60-24	23 ⁷ / ₁₆	13½	15 ⁵ / ₈	27	17 ¹³ / ₁₆	18	27 ¹³ / ₁₆	18 ⁵ / ₈	16 ⁵ / ₁₆	28¾	19 ¹¹ / ₁₆	19 ³ / ₁₆	29 ¹¹ / ₁₆	20¾	19 ¹³ / ₁₆	
	24	30	AUF(+)-30-(*)-(+)60-24	23 ⁷ / ₁₆	13½	15 ⁵ / ₈	27	17 ¹³ / ₁₆	18	27 ¹³ / ₁₆	18 ⁵ / ₈	16 ⁵ / ₁₆	28¾	19 ¹¹ / ₁₆	19 ³ / ₁₆	29 ¹¹ / ₁₆	20¾	19 ¹³ / ₁₆	
	24	36	AUF(+)-36-(*)-(+)60-24	23 ⁷ / ₁₆	13½	15 ⁵ / ₈	27	17 ¹³ / ₁₆	18	27 ¹³ / ₁₆	18 ⁵ / ₈	16 ⁵ / ₁₆	28¾	19 ¹¹ / ₁₆	19 ³ / ₁₆	29 ¹¹ / ₁₆	20¾	19 ¹³ / ₁₆	
	24	42	AUF(+)-42-(*)-(+)60-24	23 ⁷ / ₁₆	13½	15 ⁵ / ₈	27	17 ¹³ / ₁₆	18	27 ¹³ / ₁₆	18 ⁵ / ₈	16 ⁵ / ₁₆	28¾	19 ¹¹ / ₁₆	19 ³ / ₁₆	29 ¹¹ / ₁₆	20¾	19 ¹³ / ₁₆	
	 <p>Inside bend</p>	36	6	AUF(+)-06-(*)-(+)60-36	33 ¹³ / ₁₆	19½	22 ⁵ / ₁₆	37 ⁷ / ₁₆	23 ¹¹ / ₁₆	24 ¹⁵ / ₁₆	38 ³ / ₁₆	24 ⁵ / ₈	25 ⁷ / ₁₆	39 ³ / ₁₆	25 ¹¹ / ₁₆	26 ¹ / ₈	40 ¹ / ₁₆	26 ³ / ₄	26 ¹¹ / ₁₆
		36	9	AUF(+)-09-(*)-(+)60-36	33 ¹³ / ₁₆	19½	22 ⁵ / ₁₆	37 ⁷ / ₁₆	23 ¹¹ / ₁₆	24 ¹⁵ / ₁₆	38 ³ / ₁₆	24 ⁵ / ₈	25 ⁷ / ₁₆	39 ³ / ₁₆	25 ¹¹ / ₁₆	26 ¹ / ₈	40 ¹ / ₁₆	26 ³ / ₄	26 ¹¹ / ₁₆
		36	12	AUF(+)-12-(*)-(+)60-36	33 ¹³ / ₁₆	19½	22 ⁵ / ₁₆	37 ⁷ / ₁₆	23 ¹¹ / ₁₆	24 ¹⁵ / ₁₆	38 ³ / ₁₆	24 ⁵ / ₈	25 ⁷ / ₁₆	39 ³ / ₁₆	25 ¹¹ / ₁₆	26 ¹ / ₈	40 ¹ / ₁₆	26 ³ / ₄	26 ¹¹ / ₁₆
		36	18	AUF(+)-18-(*)-(+)60-36	33 ¹³ / ₁₆	19½	22 ⁵ / ₁₆	37 ⁷ / ₁₆	23 ¹¹ / ₁₆	24 ¹⁵ / ₁₆	38 ³ / ₁₆	24 ⁵ / ₈	25 ⁷ / ₁₆	39 ³ / ₁₆	25 ¹¹ / ₁₆	26 ¹ / ₈	40 ¹ / ₁₆	26 ³ / ₄	26 ¹¹ / ₁₆
		36	24	AUF(+)-24-(*)-(+)60-36	33 ¹³ / ₁₆	19½	22 ⁵ / ₁₆	37 ⁷ / ₁₆	23 ¹¹ / ₁₆	24 ¹⁵ / ₁₆	38 ³ / ₁₆	24 ⁵ / ₈	25 ⁷ / ₁₆	39 ³ / ₁₆	25 ¹¹ / ₁₆	26 ¹ / ₈	40 ¹ / ₁₆	26 ³ / ₄	26 ¹¹ / ₁₆
		36	30	AUF(+)-30-(*)-(+)60-36	33 ¹³ / ₁₆	19½	22 ⁵ / ₁₆	37 ⁷ / ₁₆	23 ¹¹ / ₁₆	24 ¹⁵ / ₁₆	38 ³ / ₁₆	24 ⁵ / ₈	25 ⁷ / ₁₆	39 ³ / ₁₆	25 ¹¹ / ₁₆	26 ¹ / ₈	40 ¹ / ₁₆	26 ³ / ₄	26 ¹¹ / ₁₆
		36	36	AUF(+)-36-(*)-(+)60-36	33 ¹³ / ₁₆	19½	22 ⁵ / ₁₆	37 ⁷ / ₁₆	23 ¹¹ / ₁₆	24 ¹⁵ / ₁₆	38 ³ / ₁₆	24 ⁵ / ₈	25 ⁷ / ₁₆	39 ³ / ₁₆	25 ¹¹ / ₁₆	26 ¹ / ₈	40 ¹ / ₁₆	26 ³ / ₄	26 ¹¹ / ₁₆
		36	42	AUF(+)-42-(*)-(+)60-36	33 ¹³ / ₁₆	19½	22 ⁵ / ₁₆	37 ⁷ / ₁₆	23 ¹¹ / ₁₆	24 ¹⁵ / ₁₆	38 ³ / ₁₆	24 ⁵ / ₈	25 ⁷ / ₁₆	39 ³ / ₁₆	25 ¹¹ / ₁₆	26 ¹ / ₈	40 ¹ / ₁₆	26 ³ / ₄	26 ¹¹ / ₁₆
48		6	AUF(+)-06-(*)-(+)60-48	44 ³ / ₁₆	25½	29 ⁷ / ₁₆	47 ¹³ / ₁₆	29 ¹¹ / ₁₆	31 ⁷ / ₈	48 ⁹ / ₁₆	30 ⁵ / ₈	32 ³ / ₈	49 ⁵ / ₁₆	31 ¹¹ / ₁₆	33 ¹ / ₁₆	50 ⁷ / ₁₆	32¾	33 ⁵ / ₈	
48		9	AUF(+)-09-(*)-(+)60-48	44 ³ / ₁₆	25½	29 ⁷ / ₁₆	47 ¹³ / ₁₆	29 ¹¹ / ₁₆	31 ⁷ / ₈	48 ⁹ / ₁₆	30 ⁵ / ₈	32 ³ / ₈	49 ⁵ / ₁₆	31 ¹¹ / ₁₆	33 ¹ / ₁₆	50 ⁷ / ₁₆	32¾	33 ⁵ / ₈	
48		12	AUF(+)-12-(*)-(+)60-48	44 ³ / ₁₆	25½	29 ⁷ / ₁₆	47 ¹³ / ₁₆	29 ¹¹ / ₁₆	31 ⁷ / ₈	48 ⁹ / ₁₆	30 ⁵ / ₈	32 ³ / ₈	49 ⁵ / ₁₆	31 ¹¹ / ₁₆	33 ¹ / ₁₆	50 ⁷ / ₁₆	32¾	33 ⁵ / ₈	
48		18	AUF(+)-18-(*)-(+)60-48	44 ³ / ₁₆	25½	29 ⁷ / ₁₆	47 ¹³ / ₁₆	29 ¹¹ / ₁₆	31 ⁷ / ₈	48 ⁹ / ₁₆	30 ⁵ / ₈	32 ³ / ₈	49 ⁵ / ₁₆	31 ¹¹ / ₁₆	33 ¹ / ₁₆	50 ⁷ / ₁₆	32¾	33 ⁵ / ₈	
48		24	AUF(+)-24-(*)-(+)60-48	44 ³ / ₁₆	25½	29 ⁷ / ₁₆	47 ¹³ / ₁₆	29 ¹¹ / ₁₆	31 ⁷ / ₈	48 ⁹ / ₁₆	30 ⁵ / ₈	32 ³ / ₈	49 ⁵ / ₁₆	31 ¹¹ / ₁₆	33 ¹ / ₁₆	50 ⁷ / ₁₆	32¾	33 ⁵ / ₈	
48		30	AUF(+)-30-(*)-(+)60-48	44 ³ / ₁₆	25½	29 ⁷ / ₁₆	47 ¹³ / ₁₆	29 ¹¹ / ₁₆	31 ⁷ / ₈	48 ⁹ / ₁₆	30 ⁵ / ₈	32 ³ / ₈	49 ⁵ / ₁₆	31 ¹¹ / ₁₆	33 ¹ / ₁₆	50 ⁷ / ₁₆	32¾	33 ⁵ / ₈	
48		36	AUF(+)-36-(*)-(+)60-48	44 ³ / ₁₆	25½	29 ⁷ / ₁₆	47 ¹³ / ₁₆	29 ¹¹ / ₁₆	31 ⁷ / ₈	48 ⁹ / ₁₆	30 ⁵ / ₈	32 ³ / ₈	49 ⁵ / ₁₆	31 ¹¹ / ₁₆	33 ¹ / ₁₆	50 ⁷ / ₁₆	32¾	33 ⁵ / ₈	
48		42	AUF(+)-42-(*)-(+)60-48	44 ³ / ₁₆	25½	29 ⁷ / ₁₆	47 ¹³ / ₁₆	29 ¹¹ / ₁₆	31 ⁷ / ₈	48 ⁹ / ₁₆	30 ⁵ / ₈	32 ³ / ₈	49 ⁵ / ₁₆	31 ¹¹ / ₁₆	33 ¹ / ₁₆	50 ⁷ / ₁₆	32¾	33 ⁵ / ₈	

(†) Insert side rail height. (*) Insert bottom style (+) Insert "VO" for vertical outside or "VI" for vertical inside to complete cat. no. Includes 1 pair of splice plates with hardware. T&B aluminum cable tray is composed of two distinct systems, H-style and U-style. These systems are interchangeable.

Part numbering system

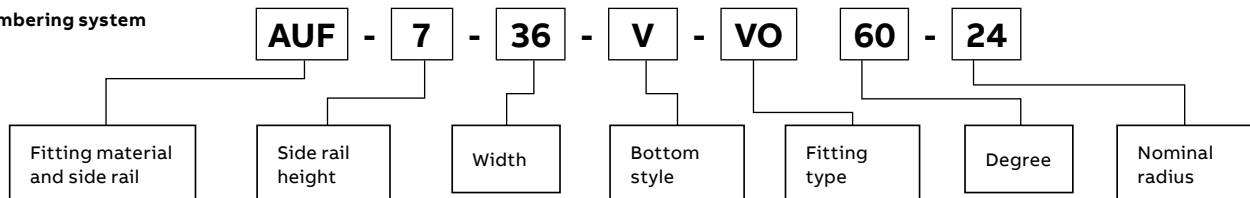



Aluminum fittings

60° H-style vertical bend fittings

Selection guide

- Inside tray widths: 6, 9, 12, 18, 24, 30, 36, 42 in.
- Angle: 60°
- Radius: 12, 24, 36, 48 in.
- Bottom styles: L– ladder, V– ventilated, S– solid
- Side rail heights: 4–7 in.

60° Vertical bend – H-style

	Nominal			Dimensions (in.)															
				(+ VO side rail									(+ VI side rail						
				4 in. – 7 in.			4 in.			5 in.			6 in.			7 in.			
Radius	Width	Cat. no.	X	Y	Z	X	Y	Z	X	Y	Z	X	Y	Z	X	Y	Z		
Outside bend 	12	6	AHF(+)-06-(*)-(+)60-12	14 ⁷ / ₈	8 ⁵ / ₁₆	9 ¹⁵ / ₁₆	18 ¹ / ₂	12 ³ / ₄	12 ⁵ / ₁₆	19 ⁵ / ₁₆	13 ¹¹ / ₁₆	12 ⁷ / ₈	20 ⁵ / ₁₆	14 ¹³ / ₁₆	13 ¹ / ₂	21 ¹ / ₈	15 ¹³ / ₁₆	14 ¹ / ₈	
	12	9	AHF(+)-09-(*)-(+)60-12	14 ⁷ / ₈	8 ⁵ / ₁₆	9 ¹⁵ / ₁₆	18 ¹ / ₂	12 ³ / ₄	12 ⁵ / ₁₆	19 ⁵ / ₁₆	13 ¹¹ / ₁₆	12 ⁷ / ₈	20 ⁵ / ₁₆	14 ¹³ / ₁₆	13 ¹ / ₂	21 ¹ / ₈	15 ¹³ / ₁₆	14 ¹ / ₈	
	12	12	AHF(+)-12-(*)-(+)60-12	14 ⁷ / ₈	8 ⁵ / ₁₆	9 ¹⁵ / ₁₆	18 ¹ / ₂	12 ³ / ₄	12 ⁵ / ₁₆	19 ⁵ / ₁₆	13 ¹¹ / ₁₆	12 ⁷ / ₈	20 ⁵ / ₁₆	14 ¹³ / ₁₆	13 ¹ / ₂	21 ¹ / ₈	15 ¹³ / ₁₆	14 ¹ / ₈	
	12	18	AHF(+)-18-(*)-(+)60-12	14 ⁷ / ₈	8 ⁵ / ₁₆	9 ¹⁵ / ₁₆	18 ¹ / ₂	12 ³ / ₄	12 ⁵ / ₁₆	19 ⁵ / ₁₆	13 ¹¹ / ₁₆	12 ⁷ / ₈	20 ⁵ / ₁₆	14 ¹³ / ₁₆	13 ¹ / ₂	21 ¹ / ₈	15 ¹³ / ₁₆	14 ¹ / ₈	
	12	24	AHF(+)-24-(*)-(+)60-12	14 ⁷ / ₈	8 ⁵ / ₁₆	9 ¹⁵ / ₁₆	18 ¹ / ₂	12 ³ / ₄	12 ⁵ / ₁₆	19 ⁵ / ₁₆	13 ¹¹ / ₁₆	12 ⁷ / ₈	20 ⁵ / ₁₆	14 ¹³ / ₁₆	13 ¹ / ₂	21 ¹ / ₈	15 ¹³ / ₁₆	14 ¹ / ₈	
	12	30	AHF(+)-30-(*)-(+)60-12	14 ⁷ / ₈	8 ⁵ / ₁₆	9 ¹⁵ / ₁₆	18 ¹ / ₂	12 ³ / ₄	12 ⁵ / ₁₆	19 ⁵ / ₁₆	13 ¹¹ / ₁₆	12 ⁷ / ₈	20 ⁵ / ₁₆	14 ¹³ / ₁₆	13 ¹ / ₂	21 ¹ / ₈	15 ¹³ / ₁₆	14 ¹ / ₈	
	12	36	AHF(+)-36-(*)-(+)60-12	14 ⁷ / ₈	8 ⁵ / ₁₆	9 ¹⁵ / ₁₆	18 ¹ / ₂	12 ³ / ₄	12 ⁵ / ₁₆	19 ⁵ / ₁₆	13 ¹¹ / ₁₆	12 ⁷ / ₈	20 ⁵ / ₁₆	14 ¹³ / ₁₆	13 ¹ / ₂	21 ¹ / ₈	15 ¹³ / ₁₆	14 ¹ / ₈	
	12	42	AHF(+)-42-(*)-(+)60-12	14 ⁷ / ₈	8 ⁵ / ₁₆	9 ¹⁵ / ₁₆	18 ¹ / ₂	12 ³ / ₄	12 ⁵ / ₁₆	19 ⁵ / ₁₆	13 ¹¹ / ₁₆	12 ⁷ / ₈	20 ⁵ / ₁₆	14 ¹³ / ₁₆	13 ¹ / ₂	21 ¹ / ₈	15 ¹³ / ₁₆	14 ¹ / ₈	
	24	6	AHF(+)-06-(*)-(+)60-24	25 ⁵ / ₁₆	14 ⁵ / ₈	16 ⁷ / ₈	28 ⁷ / ₈	18 ³ / ₄	19 ¹ / ₄	29 ¹¹ / ₁₆	19 ¹¹ / ₁₆	19 ¹³ / ₁₆	30 ¹¹ / ₁₆	20 ¹³ / ₁₆	20 ⁷ / ₁₆	31 ⁹ / ₁₆	21 ¹³ / ₁₆	21	
	24	9	AHF(+)-09-(*)-(+)60-24	25 ⁵ / ₁₆	14 ⁵ / ₈	16 ⁷ / ₈	28 ⁷ / ₈	18 ³ / ₄	19 ¹ / ₄	29 ¹¹ / ₁₆	19 ¹¹ / ₁₆	19 ¹³ / ₁₆	30 ¹¹ / ₁₆	20 ¹³ / ₁₆	20 ⁷ / ₁₆	31 ⁹ / ₁₆	21 ¹³ / ₁₆	21	
	24	12	AHF(+)-12-(*)-(+)60-24	25 ⁵ / ₁₆	14 ⁵ / ₈	16 ⁷ / ₈	28 ⁷ / ₈	18 ³ / ₄	19 ¹ / ₄	29 ¹¹ / ₁₆	19 ¹¹ / ₁₆	19 ¹³ / ₁₆	30 ¹¹ / ₁₆	20 ¹³ / ₁₆	20 ⁷ / ₁₆	31 ⁹ / ₁₆	21 ¹³ / ₁₆	21	
	24	18	AHF(+)-18-(*)-(+)60-24	25 ⁵ / ₁₆	14 ⁵ / ₈	16 ⁷ / ₈	28 ⁷ / ₈	18 ³ / ₄	19 ¹ / ₄	29 ¹¹ / ₁₆	19 ¹¹ / ₁₆	19 ¹³ / ₁₆	30 ¹¹ / ₁₆	20 ¹³ / ₁₆	20 ⁷ / ₁₆	31 ⁹ / ₁₆	21 ¹³ / ₁₆	21	
	24	24	AHF(+)-24-(*)-(+)60-24	25 ⁵ / ₁₆	14 ⁵ / ₈	16 ⁷ / ₈	28 ⁷ / ₈	18 ³ / ₄	19 ¹ / ₄	29 ¹¹ / ₁₆	19 ¹¹ / ₁₆	19 ¹³ / ₁₆	30 ¹¹ / ₁₆	20 ¹³ / ₁₆	20 ⁷ / ₁₆	31 ⁹ / ₁₆	21 ¹³ / ₁₆	21	
	24	30	AHF(+)-30-(*)-(+)60-24	25 ⁵ / ₁₆	14 ⁵ / ₈	16 ⁷ / ₈	28 ⁷ / ₈	18 ³ / ₄	19 ¹ / ₄	29 ¹¹ / ₁₆	19 ¹¹ / ₁₆	19 ¹³ / ₁₆	30 ¹¹ / ₁₆	20 ¹³ / ₁₆	20 ⁷ / ₁₆	31 ⁹ / ₁₆	21 ¹³ / ₁₆	21	
	24	36	AHF(+)-36-(*)-(+)60-24	25 ⁵ / ₁₆	14 ⁵ / ₈	16 ⁷ / ₈	28 ⁷ / ₈	18 ³ / ₄	19 ¹ / ₄	29 ¹¹ / ₁₆	19 ¹¹ / ₁₆	19 ¹³ / ₁₆	30 ¹¹ / ₁₆	20 ¹³ / ₁₆	20 ⁷ / ₁₆	31 ⁹ / ₁₆	21 ¹³ / ₁₆	21	
	24	42	AHF(+)-42-(*)-(+)60-24	25 ⁵ / ₁₆	14 ⁵ / ₈	16 ⁷ / ₈	28 ⁷ / ₈	18 ³ / ₄	19 ¹ / ₄	29 ¹¹ / ₁₆	19 ¹¹ / ₁₆	19 ¹³ / ₁₆	30 ¹¹ / ₁₆	20 ¹³ / ₁₆	20 ⁷ / ₁₆	31 ⁹ / ₁₆	21 ¹³ / ₁₆	21	
	Inside bend 	36	6	AHF(+)-06-(*)-(+)60-36	35 ¹¹ / ₁₆	20 ⁵ / ₁₆	23 ¹³ / ₁₆	39 ⁵ / ₁₆	24 ³ / ₄	26 ³ / ₁₆	40 ¹ / ₁₆	25 ¹¹ / ₁₆	26 ¹¹ / ₁₆	41 ¹ / ₁₆	26 ¹³ / ₁₆	27 ³ / ₈	41 ¹⁵ / ₁₆	27 ¹³ / ₁₆	27 ¹⁵ / ₁₆
		36	9	AHF(+)-09-(*)-(+)60-36	35 ¹¹ / ₁₆	20 ⁵ / ₁₆	23 ¹³ / ₁₆	39 ⁵ / ₁₆	24 ³ / ₄	26 ³ / ₁₆	40 ¹ / ₁₆	25 ¹¹ / ₁₆	26 ¹¹ / ₁₆	41 ¹ / ₁₆	26 ¹³ / ₁₆	27 ³ / ₈	41 ¹⁵ / ₁₆	27 ¹³ / ₁₆	27 ¹⁵ / ₁₆
		36	12	AHF(+)-12-(*)-(+)60-36	35 ¹¹ / ₁₆	20 ⁵ / ₁₆	23 ¹³ / ₁₆	39 ⁵ / ₁₆	24 ³ / ₄	26 ³ / ₁₆	40 ¹ / ₁₆	25 ¹¹ / ₁₆	26 ¹¹ / ₁₆	41 ¹ / ₁₆	26 ¹³ / ₁₆	27 ³ / ₈	41 ¹⁵ / ₁₆	27 ¹³ / ₁₆	27 ¹⁵ / ₁₆
		36	18	AHF(+)-18-(*)-(+)60-36	35 ¹¹ / ₁₆	20 ⁵ / ₁₆	23 ¹³ / ₁₆	39 ⁵ / ₁₆	24 ³ / ₄	26 ³ / ₁₆	40 ¹ / ₁₆	25 ¹¹ / ₁₆	26 ¹¹ / ₁₆	41 ¹ / ₁₆	26 ¹³ / ₁₆	27 ³ / ₈	41 ¹⁵ / ₁₆	27 ¹³ / ₁₆	27 ¹⁵ / ₁₆
		36	24	AHF(+)-24-(*)-(+)60-36	35 ¹¹ / ₁₆	20 ⁵ / ₁₆	23 ¹³ / ₁₆	39 ⁵ / ₁₆	24 ³ / ₄	26 ³ / ₁₆	40 ¹ / ₁₆	25 ¹¹ / ₁₆	26 ¹¹ / ₁₆	41 ¹ / ₁₆	26 ¹³ / ₁₆	27 ³ / ₈	41 ¹⁵ / ₁₆	27 ¹³ / ₁₆	27 ¹⁵ / ₁₆
		36	30	AHF(+)-30-(*)-(+)60-36	35 ¹¹ / ₁₆	20 ⁵ / ₁₆	23 ¹³ / ₁₆	39 ⁵ / ₁₆	24 ³ / ₄	26 ³ / ₁₆	40 ¹ / ₁₆	25 ¹¹ / ₁₆	26 ¹¹ / ₁₆	41 ¹ / ₁₆	26 ¹³ / ₁₆	27 ³ / ₈	41 ¹⁵ / ₁₆	27 ¹³ / ₁₆	27 ¹⁵ / ₁₆
		36	36	AHF(+)-36-(*)-(+)60-36	35 ¹¹ / ₁₆	20 ⁵ / ₁₆	23 ¹³ / ₁₆	39 ⁵ / ₁₆	24 ³ / ₄	26 ³ / ₁₆	40 ¹ / ₁₆	25 ¹¹ / ₁₆	26 ¹¹ / ₁₆	41 ¹ / ₁₆	26 ¹³ / ₁₆	27 ³ / ₈	41 ¹⁵ / ₁₆	27 ¹³ / ₁₆	27 ¹⁵ / ₁₆
		36	42	AHF(+)-42-(*)-(+)60-36	35 ¹¹ / ₁₆	20 ⁵ / ₁₆	23 ¹³ / ₁₆	39 ⁵ / ₁₆	24 ³ / ₄	26 ³ / ₁₆	40 ¹ / ₁₆	25 ¹¹ / ₁₆	26 ¹¹ / ₁₆	41 ¹ / ₁₆	26 ¹³ / ₁₆	27 ³ / ₈	41 ¹⁵ / ₁₆	27 ¹³ / ₁₆	27 ¹⁵ / ₁₆
48		6	AHF(+)-06-(*)-(+)60-48	46 ¹ / ₁₆	26 ⁵ / ₁₆	30 ¹¹ / ₁₆	49 ¹¹ / ₁₆	30 ³ / ₄	33 ³ / ₈	50 ⁷ / ₁₆	31 ¹¹ / ₁₆	33 ⁵ / ₈	51 ¹ / ₂	32 ¹³ / ₁₆	34 ⁵ / ₁₆	52 ⁵ / ₁₆	33 ¹³ / ₁₆	34 ⁷ / ₈	
48		9	AHF(+)-09-(*)-(+)60-48	46 ¹ / ₁₆	26 ⁵ / ₁₆	30 ¹¹ / ₁₆	49 ¹¹ / ₁₆	30 ³ / ₄	33 ³ / ₈	50 ⁷ / ₁₆	31 ¹¹ / ₁₆	33 ⁵ / ₈	51 ¹ / ₂	32 ¹³ / ₁₆	34 ⁵ / ₁₆	52 ⁵ / ₁₆	33 ¹³ / ₁₆	34 ⁷ / ₈	
48		12	AHF(+)-12-(*)-(+)60-48	46 ¹ / ₁₆	26 ⁵ / ₁₆	30 ¹¹ / ₁₆	49 ¹¹ / ₁₆	30 ³ / ₄	33 ³ / ₈	50 ⁷ / ₁₆	31 ¹¹ / ₁₆	33 ⁵ / ₈	51 ¹ / ₂	32 ¹³ / ₁₆	34 ⁵ / ₁₆	52 ⁵ / ₁₆	33 ¹³ / ₁₆	34 ⁷ / ₈	
48		18	AHF(+)-18-(*)-(+)60-48	46 ¹ / ₁₆	26 ⁵ / ₁₆	30 ¹¹ / ₁₆	49 ¹¹ / ₁₆	30 ³ / ₄	33 ³ / ₈	50 ⁷ / ₁₆	31 ¹¹ / ₁₆	33 ⁵ / ₈	51 ¹ / ₂	32 ¹³ / ₁₆	34 ⁵ / ₁₆	52 ⁵ / ₁₆	33 ¹³ / ₁₆	34 ⁷ / ₈	
48		24	AHF(+)-24-(*)-(+)60-48	46 ¹ / ₁₆	26 ⁵ / ₁₆	30 ¹¹ / ₁₆	49 ¹¹ / ₁₆	30 ³ / ₄	33 ³ / ₈	50 ⁷ / ₁₆	31 ¹¹ / ₁₆	33 ⁵ / ₈	51 ¹ / ₂	32 ¹³ / ₁₆	34 ⁵ / ₁₆	52 ⁵ / ₁₆	33 ¹³ / ₁₆	34 ⁷ / ₈	
48		30	AHF(+)-30-(*)-(+)60-48	46 ¹ / ₁₆	26 ⁵ / ₁₆	30 ¹¹ / ₁₆	49 ¹¹ / ₁₆	30 ³ / ₄	33 ³ / ₈	50 ⁷ / ₁₆	31 ¹¹ / ₁₆	33 ⁵ / ₈	51 ¹ / ₂	32 ¹³ / ₁₆	34 ⁵ / ₁₆	52 ⁵ / ₁₆	33 ¹³ / ₁₆	34 ⁷ / ₈	
48		36	AHF(+)-36-(*)-(+)60-48	46 ¹ / ₁₆	26 ⁵ / ₁₆	30 ¹¹ / ₁₆	49 ¹¹ / ₁₆	30 ³ / ₄	33 ³ / ₈	50 ⁷ / ₁₆	31 ¹¹ / ₁₆	33 ⁵ / ₈	51 ¹ / ₂	32 ¹³ / ₁₆	34 ⁵ / ₁₆	52 ⁵ / ₁₆	33 ¹³ / ₁₆	34 ⁷ / ₈	
48		42	AHF(+)-42-(*)-(+)60-48	46 ¹ / ₁₆	26 ⁵ / ₁₆	30 ¹¹ / ₁₆	49 ¹¹ / ₁₆	30 ³ / ₄	33 ³ / ₈	50 ⁷ / ₁₆	31 ¹¹ / ₁₆	33 ⁵ / ₈	51 ¹ / ₂	32 ¹³ / ₁₆	34 ⁵ / ₁₆	52 ⁵ / ₁₆	33 ¹³ / ₁₆	34 ⁷ / ₈	

(†) Insert side rail height. (*) Insert bottom style (+) Insert "VO" for vertical outside or "VI" for vertical inside to complete cat. no. Includes 1 pair of splice plates with hardware. T&B aluminum cable tray is composed of two distinct systems, H-style and U-style. These systems are interchangeable.

Part numbering system



Aluminum fittings

45° U-style vertical bend fittings

Selection guide

- Inside tray widths: 6, 9, 12, 18, 24, 30, 36, 42 in.
- Angle: 45°
- Nominal radius: 12, 24, 36, 48 in.
- Bottom styles: L- ladder, V- ventilated, S- solid
- Side rail heights: 4-7 in.

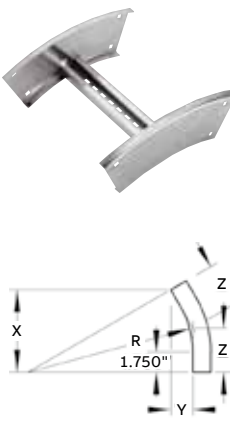
45° Vertical bend – U-style

	Nominal			Dimensions (in.)														
				(+ VO side rail						(+ VI side rail								
				4 in. – 7 in.			4 in.			5 in.			6 in.			7 in.		
Radius	Width	Cat. no.	X	Y	Z	X	Y	Z	X	Y	Z	X	Y	Z	X	Y	Z	
 <p>Outside bend</p>	12	6	AUF(+)-06-(*)-(+)45-12	11½	4¾	6¾	147/16	815/16	87/16	15½	913/16	813/16	157/8	1015/16	95/16	169/16	12	9¾
	12	9	AUF(+)-09-(*)-(+)45-12	11½	4¾	6¾	147/16	815/16	87/16	15½	913/16	813/16	157/8	1015/16	95/16	169/16	12	9¾
	12	12	AUF(+)-12-(*)-(+)45-12	11½	4¾	6¾	147/16	815/16	87/16	15½	913/16	813/16	157/8	1015/16	95/16	169/16	12	9¾
	12	18	AUF(+)-18-(*)-(+)45-12	11½	4¾	6¾	147/16	815/16	87/16	15½	913/16	813/16	157/8	1015/16	95/16	169/16	12	9¾
	12	24	AUF(+)-24-(*)-(+)45-12	11½	4¾	6¾	147/16	815/16	87/16	15½	913/16	813/16	157/8	1015/16	95/16	169/16	12	9¾
	12	30	AUF(+)-30-(*)-(+)45-12	11½	4¾	6¾	147/16	815/16	87/16	15½	913/16	813/16	157/8	1015/16	95/16	169/16	12	9¾
	12	36	AUF(+)-36-(*)-(+)45-12	11½	4¾	6¾	147/16	815/16	87/16	15½	913/16	813/16	157/8	1015/16	95/16	169/16	12	9¾
	12	42	AUF(+)-42-(*)-(+)45-12	11½	4¾	6¾	147/16	815/16	87/16	15½	913/16	813/16	157/8	1015/16	95/16	169/16	12	9¾
	24	6	AUF(+)-06-(*)-(+)45-24	1915/16	8¾	1113/16	2215/16	127/16	137/16	233/16	133/8	1313/16	245/16	147/16	14¾	25½	15½	1413/16
	24	9	AUF(+)-09-(*)-(+)45-24	1915/16	8¾	1113/16	2215/16	127/16	137/16	233/16	133/8	1313/16	245/16	147/16	14¾	25½	15½	1413/16
	24	12	AUF(+)-12-(*)-(+)45-24	1915/16	8¾	1113/16	2215/16	127/16	137/16	233/16	133/8	1313/16	245/16	147/16	14¾	25½	15½	1413/16
	24	18	AUF(+)-18-(*)-(+)45-24	1915/16	8¾	1113/16	2215/16	127/16	137/16	233/16	133/8	1313/16	245/16	147/16	14¾	25½	15½	1413/16
24	24	AUF(+)-24-(*)-(+)45-24	1915/16	8¾	1113/16	2215/16	127/16	137/16	233/16	133/8	1313/16	245/16	147/16	14¾	25½	15½	1413/16	
24	30	AUF(+)-30-(*)-(+)45-24	1915/16	8¾	1113/16	2215/16	127/16	137/16	233/16	133/8	1313/16	245/16	147/16	14¾	25½	15½	1413/16	
24	36	AUF(+)-36-(*)-(+)45-24	1915/16	8¾	1113/16	2215/16	127/16	137/16	233/16	133/8	1313/16	245/16	147/16	14¾	25½	15½	1413/16	
24	42	AUF(+)-42-(*)-(+)45-24	1915/16	8¾	1113/16	2215/16	127/16	137/16	233/16	133/8	1313/16	245/16	147/16	14¾	25½	15½	1413/16	
 <p>Inside bend</p>	36	6	AUF(+)-06-(*)-(+)45-36	287/16	1113/16	1613/16	313/8	1515/16	183/8	32½	167/8	18¾	3213/16	18	19¾	333/16	19	1911/16
	36	9	AUF(+)-09-(*)-(+)45-36	287/16	1113/16	1613/16	313/8	1515/16	183/8	32½	167/8	18¾	3213/16	18	19¾	333/16	19	1911/16
	36	12	AUF(+)-12-(*)-(+)45-36	287/16	1113/16	1613/16	313/8	1515/16	183/8	32½	167/8	18¾	3213/16	18	19¾	333/16	19	1911/16
	36	18	AUF(+)-18-(*)-(+)45-36	287/16	1113/16	1613/16	313/8	1515/16	183/8	32½	167/8	18¾	3213/16	18	19¾	333/16	19	1911/16
	36	24	AUF(+)-24-(*)-(+)45-36	287/16	1113/16	1613/16	313/8	1515/16	183/8	32½	167/8	18¾	3213/16	18	19¾	333/16	19	1911/16
	36	30	AUF(+)-30-(*)-(+)45-36	287/16	1113/16	1613/16	313/8	1515/16	183/8	32½	167/8	18¾	3213/16	18	19¾	333/16	19	1911/16
	36	36	AUF(+)-36-(*)-(+)45-36	287/16	1113/16	1613/16	313/8	1515/16	183/8	32½	167/8	18¾	3213/16	18	19¾	333/16	19	1911/16
	36	42	AUF(+)-42-(*)-(+)45-36	287/16	1113/16	1613/16	313/8	1515/16	183/8	32½	167/8	18¾	3213/16	18	19¾	333/16	19	1911/16
	48	6	AUF(+)-06-(*)-(+)45-48	3615/16	15½	21½	397/8	19½	23¾	40½	20¾	23¾	415/16	21½	243/16	42½	229/16	24¾
	48	9	AUF(+)-09-(*)-(+)45-48	3615/16	15½	21½	397/8	19½	23¾	40½	20¾	23¾	415/16	21½	243/16	42½	229/16	24¾
	48	12	AUF(+)-12-(*)-(+)45-48	3615/16	15½	21½	397/8	19½	23¾	40½	20¾	23¾	415/16	21½	243/16	42½	229/16	24¾
	48	18	AUF(+)-18-(*)-(+)45-48	3615/16	15½	21½	397/8	19½	23¾	40½	20¾	23¾	415/16	21½	243/16	42½	229/16	24¾
48	24	AUF(+)-24-(*)-(+)45-48	3615/16	15½	21½	397/8	19½	23¾	40½	20¾	23¾	415/16	21½	243/16	42½	229/16	24¾	
48	30	AUF(+)-30-(*)-(+)45-48	3615/16	15½	21½	397/8	19½	23¾	40½	20¾	23¾	415/16	21½	243/16	42½	229/16	24¾	
48	36	AUF(+)-36-(*)-(+)45-48	3615/16	15½	21½	397/8	19½	23¾	40½	20¾	23¾	415/16	21½	243/16	42½	229/16	24¾	
48	42	AUF(+)-42-(*)-(+)45-48	3615/16	15½	21½	397/8	19½	23¾	40½	20¾	23¾	415/16	21½	243/16	42½	229/16	24¾	

(†) Insert side rail height. (*) Insert bottom style (+) Insert "VO" for vertical outside or "VI" for vertical inside to complete cat. no. Includes 1 pair of splice plates with hardware. T&B aluminum cable tray is composed of two distinct systems, H-style and U-style. These systems are interchangeable.

Part numbering system

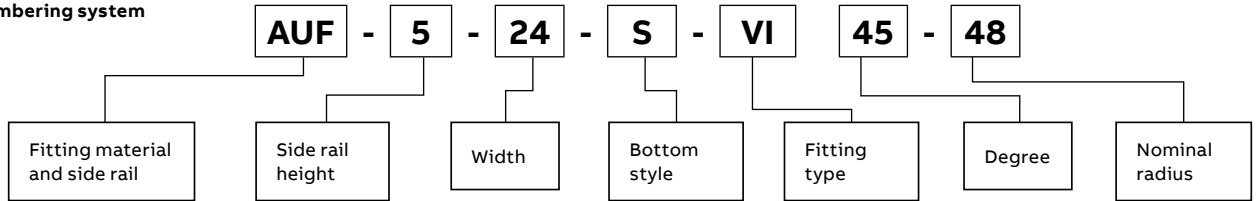

Aluminum fittings

45° H-style vertical bend fittings

Selection guide

- Inside tray widths: 6, 9, 12, 18, 24, 30, 36, 42 in.
- Angle: 45°
- Nominal radius: 12, 24, 36, 48 in.
- Bottom styles: L– ladder, V– ventilated, S– solid
- Side rail heights: 4–7 in.

45° Vertical bend – H-style

			Dimensions (in.)														
			(+ VO side rail						(+ VI side rail								
			4 in. – 7 in.			4 in.			5 in.			6 in.			7 in.		
Nominal	Radius	Width															
(in.)	(in.)	Cat. no.	X	Y	Z	X	Y	Z	X	Y	Z	X	Y	Z	X	Y	Z
Outside bend																	
																	
12	6	AHF(+)-06-(*)-(+)45-12	13 ⁹ / ₁₆	5 ⁵ / ₈	8	16 ⁹ / ₁₆	9 ¹³ / ₁₆	9 ¹³ / ₁₆	17 ³ / ₁₆	10 ¹¹ / ₁₆	10 ¹¹ / ₁₆	18	11 ⁷ / ₈	10 ⁹ / ₁₆	18 ¹¹ / ₁₆	12 ⁷ / ₈	10 ¹⁵ / ₁₆
12	9	AHF(+)-09-(*)-(+)45-12	13 ⁹ / ₁₆	5 ⁵ / ₈	8	16 ⁹ / ₁₆	9 ¹³ / ₁₆	9 ¹³ / ₁₆	17 ³ / ₁₆	10 ¹¹ / ₁₆	10 ¹¹ / ₁₆	18	11 ⁷ / ₈	10 ⁹ / ₁₆	18 ¹¹ / ₁₆	12 ⁷ / ₈	10 ¹⁵ / ₁₆
12	12	AHF(+)-12-(*)-(+)45-12	13 ⁹ / ₁₆	5 ⁵ / ₈	8	16 ⁹ / ₁₆	9 ¹³ / ₁₆	9 ¹³ / ₁₆	17 ³ / ₁₆	10 ¹¹ / ₁₆	10 ¹¹ / ₁₆	18	11 ⁷ / ₈	10 ⁹ / ₁₆	18 ¹¹ / ₁₆	12 ⁷ / ₈	10 ¹⁵ / ₁₆
12	18	AHF(+)-18-(*)-(+)45-12	13 ⁹ / ₁₆	5 ⁵ / ₈	8	16 ⁹ / ₁₆	9 ¹³ / ₁₆	9 ¹³ / ₁₆	17 ³ / ₁₆	10 ¹¹ / ₁₆	10 ¹¹ / ₁₆	18	11 ⁷ / ₈	10 ⁹ / ₁₆	18 ¹¹ / ₁₆	12 ⁷ / ₈	10 ¹⁵ / ₁₆
12	24	AHF(+)-24-(*)-(+)45-12	13 ⁹ / ₁₆	5 ⁵ / ₈	8	16 ⁹ / ₁₆	9 ¹³ / ₁₆	9 ¹³ / ₁₆	17 ³ / ₁₆	10 ¹¹ / ₁₆	10 ¹¹ / ₁₆	18	11 ⁷ / ₈	10 ⁹ / ₁₆	18 ¹¹ / ₁₆	12 ⁷ / ₈	10 ¹⁵ / ₁₆
12	30	AHF(+)-30-(*)-(+)45-12	13 ⁹ / ₁₆	5 ⁵ / ₈	8	16 ⁹ / ₁₆	9 ¹³ / ₁₆	9 ¹³ / ₁₆	17 ³ / ₁₆	10 ¹¹ / ₁₆	10 ¹¹ / ₁₆	18	11 ⁷ / ₈	10 ⁹ / ₁₆	18 ¹¹ / ₁₆	12 ⁷ / ₈	10 ¹⁵ / ₁₆
12	36	AHF(+)-36-(*)-(+)45-12	13 ⁹ / ₁₆	5 ⁵ / ₈	8	16 ⁹ / ₁₆	9 ¹³ / ₁₆	9 ¹³ / ₁₆	17 ³ / ₁₆	10 ¹¹ / ₁₆	10 ¹¹ / ₁₆	18	11 ⁷ / ₈	10 ⁹ / ₁₆	18 ¹¹ / ₁₆	12 ⁷ / ₈	10 ¹⁵ / ₁₆
12	42	AHF(+)-42-(*)-(+)45-12	13 ⁹ / ₁₆	5 ⁵ / ₈	8	16 ⁹ / ₁₆	9 ¹³ / ₁₆	9 ¹³ / ₁₆	17 ³ / ₁₆	10 ¹¹ / ₁₆	10 ¹¹ / ₁₆	18	11 ⁷ / ₈	10 ⁹ / ₁₆	18 ¹¹ / ₁₆	12 ⁷ / ₈	10 ¹⁵ / ₁₆
24	6	AHF(+)-06-(*)-(+)45-24	22 ³ / ₁₆	9 ³ / ₈	12 ¹⁵ / ₁₆	25 ³ / ₁₆	13 ³ / ₁₆	14 ¹³ / ₁₆	25 ¹¹ / ₁₆	14 ³ / ₄	15 ³ / ₁₆	26 ¹ / ₂	15 ³ / ₈	15 ¹ / ₂	27 ³ / ₁₆	16 ³ / ₈	15 ¹⁵ / ₁₆
24	9	AHF(+)-09-(*)-(+)45-24	22 ³ / ₁₆	9 ³ / ₈	12 ¹⁵ / ₁₆	25 ³ / ₁₆	13 ³ / ₁₆	14 ¹³ / ₁₆	25 ¹¹ / ₁₆	14 ³ / ₄	15 ³ / ₁₆	26 ¹ / ₂	15 ³ / ₈	15 ¹ / ₂	27 ³ / ₁₆	16 ³ / ₈	15 ¹⁵ / ₁₆
24	12	AHF(+)-12-(*)-(+)45-24	22 ³ / ₁₆	9 ³ / ₈	12 ¹⁵ / ₁₆	25 ³ / ₁₆	13 ³ / ₁₆	14 ¹³ / ₁₆	25 ¹¹ / ₁₆	14 ³ / ₄	15 ³ / ₁₆	26 ¹ / ₂	15 ³ / ₈	15 ¹ / ₂	27 ³ / ₁₆	16 ³ / ₈	15 ¹⁵ / ₁₆
24	18	AHF(+)-18-(*)-(+)45-24	22 ³ / ₁₆	9 ³ / ₈	12 ¹⁵ / ₁₆	25 ³ / ₁₆	13 ³ / ₁₆	14 ¹³ / ₁₆	25 ¹¹ / ₁₆	14 ³ / ₄	15 ³ / ₁₆	26 ¹ / ₂	15 ³ / ₈	15 ¹ / ₂	27 ³ / ₁₆	16 ³ / ₈	15 ¹⁵ / ₁₆
24	24	AHF(+)-24-(*)-(+)45-24	22 ³ / ₁₆	9 ³ / ₈	12 ¹⁵ / ₁₆	25 ³ / ₁₆	13 ³ / ₁₆	14 ¹³ / ₁₆	25 ¹¹ / ₁₆	14 ³ / ₄	15 ³ / ₁₆	26 ¹ / ₂	15 ³ / ₈	15 ¹ / ₂	27 ³ / ₁₆	16 ³ / ₈	15 ¹⁵ / ₁₆
24	30	AHF(+)-30-(*)-(+)45-24	22 ³ / ₁₆	9 ³ / ₈	12 ¹⁵ / ₁₆	25 ³ / ₁₆	13 ³ / ₁₆	14 ¹³ / ₁₆	25 ¹¹ / ₁₆	14 ³ / ₄	15 ³ / ₁₆	26 ¹ / ₂	15 ³ / ₈	15 ¹ / ₂	27 ³ / ₁₆	16 ³ / ₈	15 ¹⁵ / ₁₆
24	36	AHF(+)-36-(*)-(+)45-24	22 ³ / ₁₆	9 ³ / ₈	12 ¹⁵ / ₁₆	25 ³ / ₁₆	13 ³ / ₁₆	14 ¹³ / ₁₆	25 ¹¹ / ₁₆	14 ³ / ₄	15 ³ / ₁₆	26 ¹ / ₂	15 ³ / ₈	15 ¹ / ₂	27 ³ / ₁₆	16 ³ / ₈	15 ¹⁵ / ₁₆
24	42	AHF(+)-42-(*)-(+)45-24	22 ³ / ₁₆	9 ³ / ₈	12 ¹⁵ / ₁₆	25 ³ / ₁₆	13 ³ / ₁₆	14 ¹³ / ₁₆	25 ¹¹ / ₁₆	14 ³ / ₄	15 ³ / ₁₆	26 ¹ / ₂	15 ³ / ₈	15 ¹ / ₂	27 ³ / ₁₆	16 ³ / ₈	15 ¹⁵ / ₁₆
36	6	AHF(+)-06-(*)-(+)45-36	30 ⁹ / ₁₆	12 ¹¹ / ₁₆	17 ¹⁵ / ₁₆	33 ³ / ₂	16 ¹³ / ₁₆	19 ⁵ / ₈	34 ³ / ₁₆	17 ³ / ₄	20	35	18 ⁷ / ₈	20 ¹ / ₂	35 ¹¹ / ₁₆	19 ⁷ / ₈	20 ⁷ / ₈
36	9	AHF(+)-09-(*)-(+)45-36	30 ⁹ / ₁₆	12 ¹¹ / ₁₆	17 ¹⁵ / ₁₆	33 ³ / ₂	16 ¹³ / ₁₆	19 ⁵ / ₈	34 ³ / ₁₆	17 ³ / ₄	20	35	18 ⁷ / ₈	20 ¹ / ₂	35 ¹¹ / ₁₆	19 ⁷ / ₈	20 ⁷ / ₈
36	12	AHF(+)-12-(*)-(+)45-36	30 ⁹ / ₁₆	12 ¹¹ / ₁₆	17 ¹⁵ / ₁₆	33 ³ / ₂	16 ¹³ / ₁₆	19 ⁵ / ₈	34 ³ / ₁₆	17 ³ / ₄	20	35	18 ⁷ / ₈	20 ¹ / ₂	35 ¹¹ / ₁₆	19 ⁷ / ₈	20 ⁷ / ₈
36	18	AHF(+)-18-(*)-(+)45-36	30 ⁹ / ₁₆	12 ¹¹ / ₁₆	17 ¹⁵ / ₁₆	33 ³ / ₂	16 ¹³ / ₁₆	19 ⁵ / ₈	34 ³ / ₁₆	17 ³ / ₄	20	35	18 ⁷ / ₈	20 ¹ / ₂	35 ¹¹ / ₁₆	19 ⁷ / ₈	20 ⁷ / ₈
36	24	AHF(+)-24-(*)-(+)45-36	30 ⁹ / ₁₆	12 ¹¹ / ₁₆	17 ¹⁵ / ₁₆	33 ³ / ₂	16 ¹³ / ₁₆	19 ⁵ / ₈	34 ³ / ₁₆	17 ³ / ₄	20	35	18 ⁷ / ₈	20 ¹ / ₂	35 ¹¹ / ₁₆	19 ⁷ / ₈	20 ⁷ / ₈
36	30	AHF(+)-30-(*)-(+)45-36	30 ⁹ / ₁₆	12 ¹¹ / ₁₆	17 ¹⁵ / ₁₆	33 ³ / ₂	16 ¹³ / ₁₆	19 ⁵ / ₈	34 ³ / ₁₆	17 ³ / ₄	20	35	18 ⁷ / ₈	20 ¹ / ₂	35 ¹¹ / ₁₆	19 ⁷ / ₈	20 ⁷ / ₈
36	36	AHF(+)-36-(*)-(+)45-36	30 ⁹ / ₁₆	12 ¹¹ / ₁₆	17 ¹⁵ / ₁₆	33 ³ / ₂	16 ¹³ / ₁₆	19 ⁵ / ₈	34 ³ / ₁₆	17 ³ / ₄	20	35	18 ⁷ / ₈	20 ¹ / ₂	35 ¹¹ / ₁₆	19 ⁷ / ₈	20 ⁷ / ₈
36	42	AHF(+)-42-(*)-(+)45-36	30 ⁹ / ₁₆	12 ¹¹ / ₁₆	17 ¹⁵ / ₁₆	33 ³ / ₂	16 ¹³ / ₁₆	19 ⁵ / ₈	34 ³ / ₁₆	17 ³ / ₄	20	35	18 ⁷ / ₈	20 ¹ / ₂	35 ¹¹ / ₁₆	19 ⁷ / ₈	20 ⁷ / ₈
48	6	AHF(+)-06-(*)-(+)45-48	39 ³ / ₁₆	16 ³ / ₁₆	22 ⁷ / ₈	42	20 ³ / ₈	24 ⁵ / ₈	42 ⁵ / ₈	21 ³ / ₄	25	43 ¹ / ₂	22 ⁷ / ₁₆	25 ¹ / ₁₆	44 ³ / ₁₆	23 ³ / ₈	25 ⁷ / ₈
48	9	AHF(+)-09-(*)-(+)45-48	39 ³ / ₁₆	16 ³ / ₁₆	22 ⁷ / ₈	42	20 ³ / ₈	24 ⁵ / ₈	42 ⁵ / ₈	21 ³ / ₄	25	43 ¹ / ₂	22 ⁷ / ₁₆	25 ¹ / ₁₆	44 ³ / ₁₆	23 ³ / ₈	25 ⁷ / ₈
48	12	AHF(+)-12-(*)-(+)45-48	39 ³ / ₁₆	16 ³ / ₁₆	22 ⁷ / ₈	42	20 ³ / ₈	24 ⁵ / ₈	42 ⁵ / ₈	21 ³ / ₄	25	43 ¹ / ₂	22 ⁷ / ₁₆	25 ¹ / ₁₆	44 ³ / ₁₆	23 ³ / ₈	25 ⁷ / ₈
48	18	AHF(+)-18-(*)-(+)45-48	39 ³ / ₁₆	16 ³ / ₁₆	22 ⁷ / ₈	42	20 ³ / ₈	24 ⁵ / ₈	42 ⁵ / ₈	21 ³ / ₄	25	43 ¹ / ₂	22 ⁷ / ₁₆	25 ¹ / ₁₆	44 ³ / ₁₆	23 ³ / ₈	25 ⁷ / ₈
48	24	AHF(+)-24-(*)-(+)45-48	39 ³ / ₁₆	16 ³ / ₁₆	22 ⁷ / ₈	42	20 ³ / ₈	24 ⁵ / ₈	42 ⁵ / ₈	21 ³ / ₄	25	43 ¹ / ₂	22 ⁷ / ₁₆	25 ¹ / ₁₆	44 ³ / ₁₆	23 ³ / ₈	25 ⁷ / ₈
48	30	AHF(+)-30-(*)-(+)45-48	39 ³ / ₁₆	16 ³ / ₁₆	22 ⁷ / ₈	42	20 ³ / ₈	24 ⁵ / ₈	42 ⁵ / ₈	21 ³ / ₄	25	43 ¹ / ₂	22 ⁷ / ₁₆	25 ¹ / ₁₆	44 ³ / ₁₆	23 ³ / ₈	25 ⁷ / ₈
48	36	AHF(+)-36-(*)-(+)45-48	39 ³ / ₁₆	16 ³ / ₁₆	22 ⁷ / ₈	42	20 ³ / ₈	24 ⁵ / ₈	42 ⁵ / ₈	21 ³ / ₄	25	43 ¹ / ₂	22 ⁷ / ₁₆	25 ¹ / ₁₆	44 ³ / ₁₆	23 ³ / ₈	25 ⁷ / ₈
48	42	AHF(+)-42-(*)-(+)45-48	39 ³ / ₁₆	16 ³ / ₁₆	22 ⁷ / ₈	42	20 ³ / ₈	24 ⁵ / ₈	42 ⁵ / ₈	21 ³ / ₄	25	43 ¹ / ₂	22 ⁷ / ₁₆	25 ¹ / ₁₆	44 ³ / ₁₆	23 ³ / ₈	25 ⁷ / ₈

(†) Insert side rail height. (*) Insert bottom style (+) Insert "VO" for vertical outside or "VI" for vertical inside to complete cat. no. Includes 1 pair of splice plates with hardware. T&B aluminum cable tray is composed of two distinct systems, H-style and U-style. These systems are interchangeable.

Part numbering system

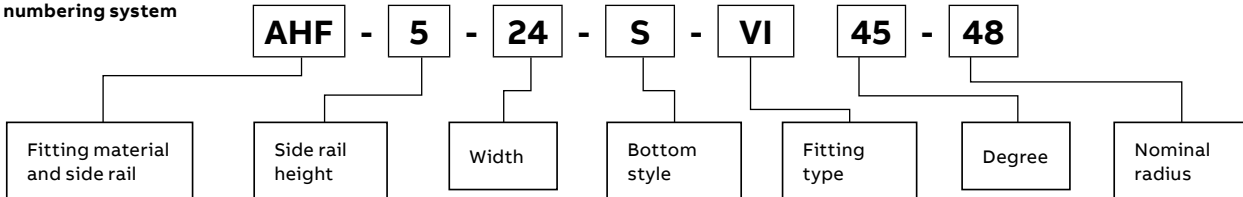

Aluminum fittings

30° U-style vertical bend fittings

Selection guide

- Inside tray widths: 6, 9, 12, 18, 24, 30, 36, 42 in.
- Angle: 30°
- Nominal radius: 12, 24, 36, 48 in.
- Bottom styles: L– ladder, V– ventilated, S– solid
- Side rail heights: 4–7 in.

30° Vertical bend – U-style

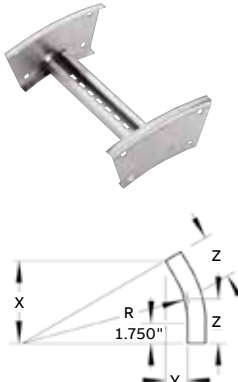
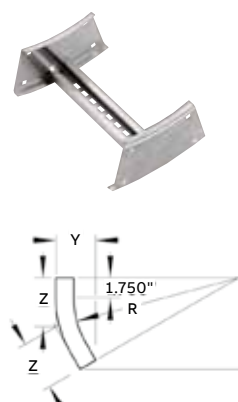
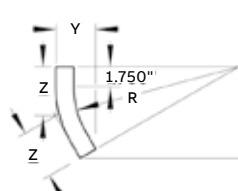
	Nominal		Cat. no.	Dimensions (in.)															
				(+) VO side rail						(+) VI side rail									
				4 in. – 7 in.			4 in.			5 in.			6 in.			7 in.			
Radius	Width		X	Y	Z	X	Y	Z	X	Y	Z	X	Y	Z					
 <p>Outside bend</p>	12	6	AUF(+)-06-(*)-(+)30-12	9¼	2½	4 ¹⁵ / ₁₆	11¾	6 ¹¹ / ₁₆	6½	11 ¹³ / ₁₆	7 ⁹ / ₁₆	6 ⁵ / ₁₆	12¾	8 ¹¹ / ₁₆	6 ⁵ / ₁₆	12 ⁷ / ₈	9¾	6 ⁷ / ₈	
	12	9	AUF(+)-09-(*)-(+)30-12	9¼	2½	4 ¹⁵ / ₁₆	11¾	6 ¹¹ / ₁₆	6½	11 ¹³ / ₁₆	7 ⁹ / ₁₆	6 ⁵ / ₁₆	12¾	8 ¹¹ / ₁₆	6 ⁵ / ₁₆	12 ⁷ / ₈	9¾	6 ⁷ / ₈	
	12	12	AUF(+)-12-(*)-(+)30-12	9¼	2½	4 ¹⁵ / ₁₆	11¾	6 ¹¹ / ₁₆	6½	11 ¹³ / ₁₆	7 ⁹ / ₁₆	6 ⁵ / ₁₆	12¾	8 ¹¹ / ₁₆	6 ⁵ / ₁₆	12 ⁷ / ₈	9¾	6 ⁷ / ₈	
	12	18	AUF(+)-18-(*)-(+)30-12	9¼	2½	4 ¹⁵ / ₁₆	11¾	6 ¹¹ / ₁₆	6½	11 ¹³ / ₁₆	7 ⁹ / ₁₆	6 ⁵ / ₁₆	12¾	8 ¹¹ / ₁₆	6 ⁵ / ₁₆	12 ⁷ / ₈	9¾	6 ⁷ / ₈	
	12	24	AUF(+)-24-(*)-(+)30-12	9¼	2½	4 ¹⁵ / ₁₆	11¾	6 ¹¹ / ₁₆	6½	11 ¹³ / ₁₆	7 ⁹ / ₁₆	6 ⁵ / ₁₆	12¾	8 ¹¹ / ₁₆	6 ⁵ / ₁₆	12 ⁷ / ₈	9¾	6 ⁷ / ₈	
	12	30	AUF(+)-30-(*)-(+)30-12	9¼	2½	4 ¹⁵ / ₁₆	11¾	6 ¹¹ / ₁₆	6½	11 ¹³ / ₁₆	7 ⁹ / ₁₆	6 ⁵ / ₁₆	12¾	8 ¹¹ / ₁₆	6 ⁵ / ₁₆	12 ⁷ / ₈	9¾	6 ⁷ / ₈	
	12	36	AUF(+)-36-(*)-(+)30-12	9¼	2½	4 ¹⁵ / ₁₆	11¾	6 ¹¹ / ₁₆	6½	11 ¹³ / ₁₆	7 ⁹ / ₁₆	6 ⁵ / ₁₆	12¾	8 ¹¹ / ₁₆	6 ⁵ / ₁₆	12 ⁷ / ₈	9¾	6 ⁷ / ₈	
	12	42	AUF(+)-42-(*)-(+)30-12	9¼	2½	4 ¹⁵ / ₁₆	11¾	6 ¹¹ / ₁₆	6½	11 ¹³ / ₁₆	7 ⁹ / ₁₆	6 ⁵ / ₁₆	12¾	8 ¹¹ / ₁₆	6 ⁵ / ₁₆	12 ⁷ / ₈	9¾	6 ⁷ / ₈	
	 <p>Inside bend</p>	24	6	AUF(+)-06-(*)-(+)30-24	15¼	4½	8 ³ / ₁₆	17¾	8¾	9 ⁵ / ₁₆	17 ¹³ / ₁₆	9 ³ / ₁₆	9 ¹ / ₁₆	18¾	10¼	9 ¹³ / ₁₆	18 ⁷ / ₈	11 ⁵ / ₁₆	10 ³ / ₈
		24	9	AUF(+)-09-(*)-(+)30-24	15¼	4½	8 ³ / ₁₆	17¾	8¾	9 ⁵ / ₁₆	17 ¹³ / ₁₆	9 ³ / ₁₆	9 ¹ / ₁₆	18¾	10¼	9 ¹³ / ₁₆	18 ⁷ / ₈	11 ⁵ / ₁₆	10 ³ / ₈
		24	12	AUF(+)-12-(*)-(+)30-24	15¼	4½	8 ³ / ₁₆	17¾	8¾	9 ⁵ / ₁₆	17 ¹³ / ₁₆	9 ³ / ₁₆	9 ¹ / ₁₆	18¾	10¼	9 ¹³ / ₁₆	18 ⁷ / ₈	11 ⁵ / ₁₆	10 ³ / ₈
		24	18	AUF(+)-18-(*)-(+)30-24	15¼	4½	8 ³ / ₁₆	17¾	8¾	9 ⁵ / ₁₆	17 ¹³ / ₁₆	9 ³ / ₁₆	9 ¹ / ₁₆	18¾	10¼	9 ¹³ / ₁₆	18 ⁷ / ₈	11 ⁵ / ₁₆	10 ³ / ₈
24		24	AUF(+)-24-(*)-(+)30-24	15¼	4½	8 ³ / ₁₆	17¾	8¾	9 ⁵ / ₁₆	17 ¹³ / ₁₆	9 ³ / ₁₆	9 ¹ / ₁₆	18¾	10¼	9 ¹³ / ₁₆	18 ⁷ / ₈	11 ⁵ / ₁₆	10 ³ / ₈	
24		30	AUF(+)-30-(*)-(+)30-24	15¼	4½	8 ³ / ₁₆	17¾	8¾	9 ⁵ / ₁₆	17 ¹³ / ₁₆	9 ³ / ₁₆	9 ¹ / ₁₆	18¾	10¼	9 ¹³ / ₁₆	18 ⁷ / ₈	11 ⁵ / ₁₆	10 ³ / ₈	
24		36	AUF(+)-36-(*)-(+)30-24	15¼	4½	8 ³ / ₁₆	17¾	8¾	9 ⁵ / ₁₆	17 ¹³ / ₁₆	9 ³ / ₁₆	9 ¹ / ₁₆	18¾	10¼	9 ¹³ / ₁₆	18 ⁷ / ₈	11 ⁵ / ₁₆	10 ³ / ₈	
24		42	AUF(+)-42-(*)-(+)30-24	15¼	4½	8 ³ / ₁₆	17¾	8¾	9 ⁵ / ₁₆	17 ¹³ / ₁₆	9 ³ / ₁₆	9 ¹ / ₁₆	18¾	10¼	9 ¹³ / ₁₆	18 ⁷ / ₈	11 ⁵ / ₁₆	10 ³ / ₈	
36		6	AUF(+)-06-(*)-(+)30-36	21¼	5 ¹¹ / ₁₆	11¾	23¾	9 ⁷ / ₈	12½	23 ¹³ / ₁₆	10¾	12¾	24¾	11 ⁷ / ₈	13½	24 ⁷ / ₈	12 ¹⁵ / ₁₆	13 ³ / ₈	
36		9	AUF(+)-09-(*)-(+)30-36	21¼	5 ¹¹ / ₁₆	11¾	23¾	9 ⁷ / ₈	12½	23 ¹³ / ₁₆	10¾	12¾	24¾	11 ⁷ / ₈	13½	24 ⁷ / ₈	12 ¹⁵ / ₁₆	13 ³ / ₈	
36		12	AUF(+)-12-(*)-(+)30-36	21¼	5 ¹¹ / ₁₆	11¾	23¾	9 ⁷ / ₈	12½	23 ¹³ / ₁₆	10¾	12¾	24¾	11 ⁷ / ₈	13½	24 ⁷ / ₈	12 ¹⁵ / ₁₆	13 ³ / ₈	
36		18	AUF(+)-18-(*)-(+)30-36	21¼	5 ¹¹ / ₁₆	11¾	23¾	9 ⁷ / ₈	12½	23 ¹³ / ₁₆	10¾	12¾	24¾	11 ⁷ / ₈	13½	24 ⁷ / ₈	12 ¹⁵ / ₁₆	13 ³ / ₈	
36	24	AUF(+)-24-(*)-(+)30-36	21¼	5 ¹¹ / ₁₆	11¾	23¾	9 ⁷ / ₈	12½	23 ¹³ / ₁₆	10¾	12¾	24¾	11 ⁷ / ₈	13½	24 ⁷ / ₈	12 ¹⁵ / ₁₆	13 ³ / ₈		
36	30	AUF(+)-30-(*)-(+)30-36	21¼	5 ¹¹ / ₁₆	11¾	23¾	9 ⁷ / ₈	12½	23 ¹³ / ₁₆	10¾	12¾	24¾	11 ⁷ / ₈	13½	24 ⁷ / ₈	12 ¹⁵ / ₁₆	13 ³ / ₈		
36	36	AUF(+)-36-(*)-(+)30-36	21¼	5 ¹¹ / ₁₆	11¾	23¾	9 ⁷ / ₈	12½	23 ¹³ / ₁₆	10¾	12¾	24¾	11 ⁷ / ₈	13½	24 ⁷ / ₈	12 ¹⁵ / ₁₆	13 ³ / ₈		
36	42	AUF(+)-42-(*)-(+)30-36	21¼	5 ¹¹ / ₁₆	11¾	23¾	9 ⁷ / ₈	12½	23 ¹³ / ₁₆	10¾	12¾	24¾	11 ⁷ / ₈	13½	24 ⁷ / ₈	12 ¹⁵ / ₁₆	13 ³ / ₈		
	48	6	AUF(+)-06-(*)-(+)30-48	21¼	7 ¹⁵ / ₁₆	14 ⁵ / ₈	29¾	11½	15¾	29 ¹³ / ₁₆	12¾	16	30¾	13½	16¼	30 ⁷ / ₈	14 ⁹ / ₁₆	16 ³ / ₈	
	48	9	AUF(+)-09-(*)-(+)30-48	21¼	7 ¹⁵ / ₁₆	14 ⁵ / ₈	29¾	11½	15¾	29 ¹³ / ₁₆	12¾	16	30¾	13½	16¼	30 ⁷ / ₈	14 ⁹ / ₁₆	16 ³ / ₈	
	48	12	AUF(+)-12-(*)-(+)30-48	21¼	7 ¹⁵ / ₁₆	14 ⁵ / ₈	29¾	11½	15¾	29 ¹³ / ₁₆	12¾	16	30¾	13½	16¼	30 ⁷ / ₈	14 ⁹ / ₁₆	16 ³ / ₈	
	48	18	AUF(+)-18-(*)-(+)30-48	21¼	7 ¹⁵ / ₁₆	14 ⁵ / ₈	29¾	11½	15¾	29 ¹³ / ₁₆	12¾	16	30¾	13½	16¼	30 ⁷ / ₈	14 ⁹ / ₁₆	16 ³ / ₈	
	48	24	AUF(+)-24-(*)-(+)30-48	21¼	7 ¹⁵ / ₁₆	14 ⁵ / ₈	29¾	11½	15¾	29 ¹³ / ₁₆	12¾	16	30¾	13½	16¼	30 ⁷ / ₈	14 ⁹ / ₁₆	16 ³ / ₈	
	48	30	AUF(+)-30-(*)-(+)30-48	21¼	7 ¹⁵ / ₁₆	14 ⁵ / ₈	29¾	11½	15¾	29 ¹³ / ₁₆	12¾	16	30¾	13½	16¼	30 ⁷ / ₈	14 ⁹ / ₁₆	16 ³ / ₈	
	48	36	AUF(+)-36-(*)-(+)30-48	21¼	7 ¹⁵ / ₁₆	14 ⁵ / ₈	29¾	11½	15¾	29 ¹³ / ₁₆	12¾	16	30¾	13½	16¼	30 ⁷ / ₈	14 ⁹ / ₁₆	16 ³ / ₈	
	48	42	AUF(+)-42-(*)-(+)30-48	21¼	7 ¹⁵ / ₁₆	14 ⁵ / ₈	29¾	11½	15¾	29 ¹³ / ₁₆	12¾	16	30¾	13½	16¼	30 ⁷ / ₈	14 ⁹ / ₁₆	16 ³ / ₈	

(†) Insert side rail height. (*) Insert bottom style (+) Insert "VO" for vertical outside or "VI" for vertical inside to complete cat. no. Includes 1 pair of splice plates with hardware. T&B aluminum cable tray is composed of two distinct systems, H-style and U-style. These systems are interchangeable.

Part numbering system

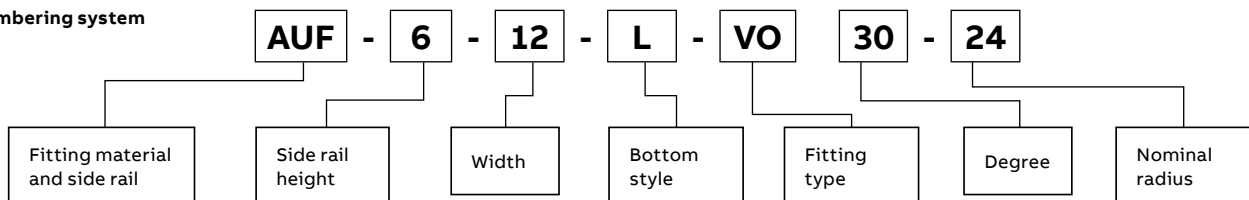

Aluminum fittings

30° H-style vertical bend fittings

Selection guide

- Inside tray widths: 6, 9, 12, 18, 24, 30, 36, 42 in.
- Angle: 30°
- Nominal radius: 12, 24, 36, 48 in.
- Bottom styles: L- ladder, V- ventilated, S- solid
- Side rail heights: 4-7 in.

30° Vertical bend – H-style

	Nominal		Cat. no.	Dimensions (in.)															
				(+) VO side rail						(+) VI side rail									
				4 in. – 7 in.			4 in.			5 in.			6 in.			7 in.			
Radius (in.)	Width (in.)		X	Y	Z	X	Y	Z	X	Y	Z	X	Y	Z					
	12	6	AHF(+)-06-(*)-(+)30-12	11 ⁵ / ₁₆	3 ¹ / ₈	6 ³ / ₁₆	13 ¹¹ / ₁₆	7 ⁵ / ₁₆	7 ⁵ / ₁₆	14 ¹ / ₈	8 ³ / ₁₆	7 ⁹ / ₁₆	14 ¹¹ / ₁₆	9 ³ / ₁₆	7 ⁷ / ₁₆	13 ¹¹ / ₁₆	10 ⁹ / ₁₆	8 ¹ / ₁₆	
	12	9	AHF(+)-09-(*)-(+)30-12	11 ⁵ / ₁₆	3 ¹ / ₈	6 ³ / ₁₆	13 ¹¹ / ₁₆	7 ⁵ / ₁₆	7 ⁵ / ₁₆	14 ¹ / ₈	8 ³ / ₁₆	7 ⁹ / ₁₆	14 ¹¹ / ₁₆	9 ³ / ₁₆	7 ⁷ / ₁₆	13 ¹¹ / ₁₆	10 ⁹ / ₁₆	8 ¹ / ₁₆	
	12	12	AHF(+)-12-(*)-(+)30-12	11 ⁵ / ₁₆	3 ¹ / ₈	6 ³ / ₁₆	13 ¹¹ / ₁₆	7 ⁵ / ₁₆	7 ⁵ / ₁₆	14 ¹ / ₈	8 ³ / ₁₆	7 ⁹ / ₁₆	14 ¹¹ / ₁₆	9 ³ / ₁₆	7 ⁷ / ₁₆	13 ¹¹ / ₁₆	10 ⁹ / ₁₆	8 ¹ / ₁₆	
	12	18	AHF(+)-18-(*)-(+)30-12	11 ⁵ / ₁₆	3 ¹ / ₈	6 ³ / ₁₆	13 ¹¹ / ₁₆	7 ⁵ / ₁₆	7 ⁵ / ₁₆	14 ¹ / ₈	8 ³ / ₁₆	7 ⁹ / ₁₆	14 ¹¹ / ₁₆	9 ³ / ₁₆	7 ⁷ / ₁₆	13 ¹¹ / ₁₆	10 ⁹ / ₁₆	8 ¹ / ₁₆	
	12	24	AHF(+)-24-(*)-(+)30-12	11 ⁵ / ₁₆	3 ¹ / ₈	6 ³ / ₁₆	13 ¹¹ / ₁₆	7 ⁵ / ₁₆	7 ⁵ / ₁₆	14 ¹ / ₈	8 ³ / ₁₆	7 ⁹ / ₁₆	14 ¹¹ / ₁₆	9 ³ / ₁₆	7 ⁷ / ₁₆	13 ¹¹ / ₁₆	10 ⁹ / ₁₆	8 ¹ / ₁₆	
	12	30	AHF(+)-30-(*)-(+)30-12	11 ⁵ / ₁₆	3 ¹ / ₈	6 ³ / ₁₆	13 ¹¹ / ₁₆	7 ⁵ / ₁₆	7 ⁵ / ₁₆	14 ¹ / ₈	8 ³ / ₁₆	7 ⁹ / ₁₆	14 ¹¹ / ₁₆	9 ³ / ₁₆	7 ⁷ / ₁₆	13 ¹¹ / ₁₆	10 ⁹ / ₁₆	8 ¹ / ₁₆	
	12	36	AHF(+)-36-(*)-(+)30-12	11 ⁵ / ₁₆	3 ¹ / ₈	6 ³ / ₁₆	13 ¹¹ / ₁₆	7 ⁵ / ₁₆	7 ⁵ / ₁₆	14 ¹ / ₈	8 ³ / ₁₆	7 ⁹ / ₁₆	14 ¹¹ / ₁₆	9 ³ / ₁₆	7 ⁷ / ₁₆	13 ¹¹ / ₁₆	10 ⁹ / ₁₆	8 ¹ / ₁₆	
	12	42	AHF(+)-42-(*)-(+)30-12	11 ⁵ / ₁₆	3 ¹ / ₈	6 ³ / ₁₆	13 ¹¹ / ₁₆	7 ⁵ / ₁₆	7 ⁵ / ₁₆	14 ¹ / ₈	8 ³ / ₁₆	7 ⁹ / ₁₆	14 ¹¹ / ₁₆	9 ³ / ₁₆	7 ⁷ / ₁₆	13 ¹¹ / ₁₆	10 ⁹ / ₁₆	8 ¹ / ₁₆	
		24	6	AHF(+)-06-(*)-(+)30-24	17 ⁵ / ₁₆	4 ¹¹ / ₁₆	9 ⁷ / ₁₆	19 ¹¹ / ₁₆	8 ⁷ / ₁₆	10 ⁹ / ₁₆	20 ¹ / ₈	9 ¹³ / ₁₆	10 ¹³ / ₁₆	20 ¹¹ / ₁₆	10 ¹⁵ / ₁₆	11 ¹ / ₈	19 ¹¹ / ₁₆	11 ¹⁵ / ₁₆	11 ³ / ₁₆
		24	9	AHF(+)-09-(*)-(+)30-24	17 ⁵ / ₁₆	4 ¹¹ / ₁₆	9 ⁷ / ₁₆	19 ¹¹ / ₁₆	8 ⁷ / ₁₆	10 ⁹ / ₁₆	20 ¹ / ₈	9 ¹³ / ₁₆	10 ¹³ / ₁₆	20 ¹¹ / ₁₆	10 ¹⁵ / ₁₆	11 ¹ / ₈	19 ¹¹ / ₁₆	11 ¹⁵ / ₁₆	11 ³ / ₁₆
		24	12	AHF(+)-12-(*)-(+)30-24	17 ⁵ / ₁₆	4 ¹¹ / ₁₆	9 ⁷ / ₁₆	19 ¹¹ / ₁₆	8 ⁷ / ₁₆	10 ⁹ / ₁₆	20 ¹ / ₈	9 ¹³ / ₁₆	10 ¹³ / ₁₆	20 ¹¹ / ₁₆	10 ¹⁵ / ₁₆	11 ¹ / ₈	19 ¹¹ / ₁₆	11 ¹⁵ / ₁₆	11 ³ / ₁₆
		24	18	AHF(+)-18-(*)-(+)30-24	17 ⁵ / ₁₆	4 ¹¹ / ₁₆	9 ⁷ / ₁₆	19 ¹¹ / ₁₆	8 ⁷ / ₁₆	10 ⁹ / ₁₆	20 ¹ / ₈	9 ¹³ / ₁₆	10 ¹³ / ₁₆	20 ¹¹ / ₁₆	10 ¹⁵ / ₁₆	11 ¹ / ₈	19 ¹¹ / ₁₆	11 ¹⁵ / ₁₆	11 ³ / ₁₆
24		24	AHF(+)-24-(*)-(+)30-24	17 ⁵ / ₁₆	4 ¹¹ / ₁₆	9 ⁷ / ₁₆	19 ¹¹ / ₁₆	8 ⁷ / ₁₆	10 ⁹ / ₁₆	20 ¹ / ₈	9 ¹³ / ₁₆	10 ¹³ / ₁₆	20 ¹¹ / ₁₆	10 ¹⁵ / ₁₆	11 ¹ / ₈	19 ¹¹ / ₁₆	11 ¹⁵ / ₁₆	11 ³ / ₁₆	
24		30	AHF(+)-30-(*)-(+)30-24	17 ⁵ / ₁₆	4 ¹¹ / ₁₆	9 ⁷ / ₁₆	19 ¹¹ / ₁₆	8 ⁷ / ₁₆	10 ⁹ / ₁₆	20 ¹ / ₈	9 ¹³ / ₁₆	10 ¹³ / ₁₆	20 ¹¹ / ₁₆	10 ¹⁵ / ₁₆	11 ¹ / ₈	19 ¹¹ / ₁₆	11 ¹⁵ / ₁₆	11 ³ / ₁₆	
24		36	AHF(+)-36-(*)-(+)30-24	17 ⁵ / ₁₆	4 ¹¹ / ₁₆	9 ⁷ / ₁₆	19 ¹¹ / ₁₆	8 ⁷ / ₁₆	10 ⁹ / ₁₆	20 ¹ / ₈	9 ¹³ / ₁₆	10 ¹³ / ₁₆	20 ¹¹ / ₁₆	10 ¹⁵ / ₁₆	11 ¹ / ₈	19 ¹¹ / ₁₆	11 ¹⁵ / ₁₆	11 ³ / ₁₆	
24		42	AHF(+)-42-(*)-(+)30-24	17 ⁵ / ₁₆	4 ¹¹ / ₁₆	9 ⁷ / ₁₆	19 ¹¹ / ₁₆	8 ⁷ / ₁₆	10 ⁹ / ₁₆	20 ¹ / ₈	9 ¹³ / ₁₆	10 ¹³ / ₁₆	20 ¹¹ / ₁₆	10 ¹⁵ / ₁₆	11 ¹ / ₈	19 ¹¹ / ₁₆	11 ¹⁵ / ₁₆	11 ³ / ₁₆	
		36	6	AHF(+)-06-(*)-(+)30-36	23 ³ / ₁₆	6 ⁵ / ₁₆	12 ⁵ / ₁₆	25 ¹¹ / ₁₆	10 ¹ / ₂	13 ³ / ₈	26 ¹ / ₈	11 ³ / ₁₆	14 ²⁶ / ₁₆	12 ⁹ / ₁₆	14 ⁵ / ₁₆	25 ¹¹ / ₁₆	13 ⁹ / ₁₆	14 ⁹ / ₁₆	
		36	9	AHF(+)-09-(*)-(+)30-36	23 ³ / ₁₆	6 ⁵ / ₁₆	12 ⁵ / ₁₆	25 ¹¹ / ₁₆	10 ¹ / ₂	13 ³ / ₈	26 ¹ / ₈	11 ³ / ₁₆	14 ²⁶ / ₁₆	12 ⁹ / ₁₆	14 ⁵ / ₁₆	25 ¹¹ / ₁₆	13 ⁹ / ₁₆	14 ⁹ / ₁₆	
		36	12	AHF(+)-12-(*)-(+)30-36	23 ³ / ₁₆	6 ⁵ / ₁₆	12 ⁵ / ₁₆	25 ¹¹ / ₁₆	10 ¹ / ₂	13 ³ / ₈	26 ¹ / ₈	11 ³ / ₁₆	14 ²⁶ / ₁₆	12 ⁹ / ₁₆	14 ⁵ / ₁₆	25 ¹¹ / ₁₆	13 ⁹ / ₁₆	14 ⁹ / ₁₆	
		36	18	AHF(+)-18-(*)-(+)30-36	23 ³ / ₁₆	6 ⁵ / ₁₆	12 ⁵ / ₁₆	25 ¹¹ / ₁₆	10 ¹ / ₂	13 ³ / ₈	26 ¹ / ₈	11 ³ / ₁₆	14 ²⁶ / ₁₆	12 ⁹ / ₁₆	14 ⁵ / ₁₆	25 ¹¹ / ₁₆	13 ⁹ / ₁₆	14 ⁹ / ₁₆	
	36	24	AHF(+)-24-(*)-(+)30-36	23 ³ / ₁₆	6 ⁵ / ₁₆	12 ⁵ / ₁₆	25 ¹¹ / ₁₆	10 ¹ / ₂	13 ³ / ₈	26 ¹ / ₈	11 ³ / ₁₆	14 ²⁶ / ₁₆	12 ⁹ / ₁₆	14 ⁵ / ₁₆	25 ¹¹ / ₁₆	13 ⁹ / ₁₆	14 ⁹ / ₁₆		
	36	30	AHF(+)-30-(*)-(+)30-36	23 ³ / ₁₆	6 ⁵ / ₁₆	12 ⁵ / ₁₆	25 ¹¹ / ₁₆	10 ¹ / ₂	13 ³ / ₈	26 ¹ / ₈	11 ³ / ₁₆	14 ²⁶ / ₁₆	12 ⁹ / ₁₆	14 ⁵ / ₁₆	25 ¹¹ / ₁₆	13 ⁹ / ₁₆	14 ⁹ / ₁₆		
	36	36	AHF(+)-36-(*)-(+)30-36	23 ³ / ₁₆	6 ⁵ / ₁₆	12 ⁵ / ₁₆	25 ¹¹ / ₁₆	10 ¹ / ₂	13 ³ / ₈	26 ¹ / ₈	11 ³ / ₁₆	14 ²⁶ / ₁₆	12 ⁹ / ₁₆	14 ⁵ / ₁₆	25 ¹¹ / ₁₆	13 ⁹ / ₁₆	14 ⁹ / ₁₆		
	36	42	AHF(+)-42-(*)-(+)30-36	23 ³ / ₁₆	6 ⁵ / ₁₆	12 ⁵ / ₁₆	25 ¹¹ / ₁₆	10 ¹ / ₂	13 ³ / ₈	26 ¹ / ₈	11 ³ / ₁₆	14 ²⁶ / ₁₆	12 ⁹ / ₁₆	14 ⁵ / ₁₆	25 ¹¹ / ₁₆	13 ⁹ / ₁₆	14 ⁹ / ₁₆		
		48	6	AHF(+)-06-(*)-(+)30-48	29 ⁵ / ₁₆	7 ¹⁵ / ₁₆	15 ⁷ / ₁₆	31 ¹¹ / ₁₆	12 ³ / ₈	17	32 ¹ / ₈	13	17 ³ / ₄	32 ¹¹ / ₁₆	14 ³ / ₁₆	17 ⁹ / ₁₆	31 ¹¹ / ₁₆	15 ⁷ / ₁₆	17 ¹³ / ₁₆
		48	9	AHF(+)-09-(*)-(+)30-48	29 ⁵ / ₁₆	7 ¹⁵ / ₁₆	15 ⁷ / ₁₆	31 ¹¹ / ₁₆	12 ³ / ₈	17	32 ¹ / ₈	13	17 ³ / ₄	32 ¹¹ / ₁₆	14 ³ / ₁₆	17 ⁹ / ₁₆	31 ¹¹ / ₁₆	15 ⁷ / ₁₆	17 ¹³ / ₁₆
		48	12	AHF(+)-12-(*)-(+)30-48	29 ⁵ / ₁₆	7 ¹⁵ / ₁₆	15 ⁷ / ₁₆	31 ¹¹ / ₁₆	12 ³ / ₈	17	32 ¹ / ₈	13	17 ³ / ₄	32 ¹¹ / ₁₆	14 ³ / ₁₆	17 ⁹ / ₁₆	31 ¹¹ / ₁₆	15 ⁷ / ₁₆	17 ¹³ / ₁₆
		48	18	AHF(+)-18-(*)-(+)30-48	29 ⁵ / ₁₆	7 ¹⁵ / ₁₆	15 ⁷ / ₁₆	31 ¹¹ / ₁₆	12 ³ / ₈	17	32 ¹ / ₈	13	17 ³ / ₄	32 ¹¹ / ₁₆	14 ³ / ₁₆	17 ⁹ / ₁₆	31 ¹¹ / ₁₆	15 ⁷ / ₁₆	17 ¹³ / ₁₆
48		24	AHF(+)-24-(*)-(+)30-48	29 ⁵ / ₁₆	7 ¹⁵ / ₁₆	15 ⁷ / ₁₆	31 ¹¹ / ₁₆	12 ³ / ₈	17	32 ¹ / ₈	13	17 ³ / ₄	32 ¹¹ / ₁₆	14 ³ / ₁₆	17 ⁹ / ₁₆	31 ¹¹ / ₁₆	15 ⁷ / ₁₆	17 ¹³ / ₁₆	
48		30	AHF(+)-30-(*)-(+)30-48	29 ⁵ / ₁₆	7 ¹⁵ / ₁₆	15 ⁷ / ₁₆	31 ¹¹ / ₁₆	12 ³ / ₈	17	32 ¹ / ₈	13	17 ³ / ₄	32 ¹¹ / ₁₆	14 ³ / ₁₆	17 ⁹ / ₁₆	31 ¹¹ / ₁₆	15 ⁷ / ₁₆	17 ¹³ / ₁₆	
	48	36	AHF(+)-36-(*)-(+)30-48	29 ⁵ / ₁₆	7 ¹⁵ / ₁₆	15 ⁷ / ₁₆	31 ¹¹ / ₁₆	12 ³ / ₈	17	32 ¹ / ₈	13	17 ³ / ₄	32 ¹¹ / ₁₆	14 ³ / ₁₆	17 ⁹ / ₁₆	31 ¹¹ / ₁₆	15 ⁷ / ₁₆	17 ¹³ / ₁₆	
	48	42	AHF(+)-42-(*)-(+)30-48	29 ⁵ / ₁₆	7 ¹⁵ / ₁₆	15 ⁷ / ₁₆	31 ¹¹ / ₁₆	12 ³ / ₈	17	32 ¹ / ₈	13	17 ³ / ₄	32 ¹¹ / ₁₆	14 ³ / ₁₆	17 ⁹ / ₁₆	31 ¹¹ / ₁₆	15 ⁷ / ₁₆	17 ¹³ / ₁₆	

(†) Insert side rail height. (*) Insert bottom style (+) Insert “VO” for vertical outside or “VI” for vertical inside to complete cat. no. Includes 1 pair of splice plates with hardware. T&B aluminum cable tray is composed of two distinct systems, H-style and U-style. These systems are interchangeable.

Part numbering system

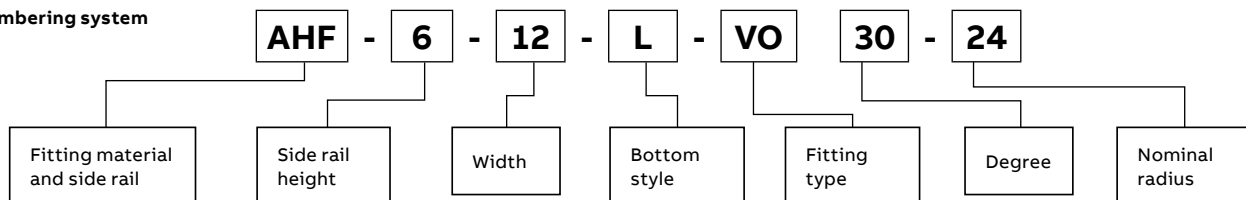



Aluminum fittings

U-style vertical tee up/down fittings

Selection guide

- Inside tray widths: 6, 9, 12, 18, 24, 30, 36, 42 in.
- Nominal radius: 12, 24, 36, 48 in.
- Bottom styles: L- ladder, V- ventilated, S- solid
- Side rail heights: 4-7 in.

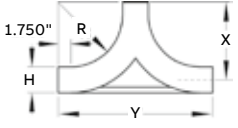
Vertical tee up/down - U-style

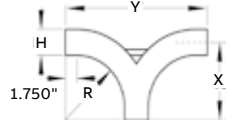
	Nominal		Vertical tee up Cat. no.	Vertical tee down Cat. no.	Dimensions (in.)								
					Side rail height "H"								
					4 in.		5 in.		6 in.		7 in.		
Radius (in.)	Width (in.)			X	Y	X	Y	X	Y	X	Y		
Up 	12	6	AUF(†)-06-(*)-VTU12	AUF(†)-06-(*)-VTD12	15 ¹³ / ₁₆	31 ¹¹ / ₁₆	16 ⁵ / ₁₆	32 ⁹ / ₁₆	16 ⁷ / ₈	33 ³ / ₄	17 ³ / ₈	34 ³ / ₄	
	12	9	AUF(†)-09-(*)-VTU12	AUF(†)-09-(*)-VTD12	15 ¹³ / ₁₆	31 ¹¹ / ₁₆	16 ⁵ / ₁₆	32 ⁹ / ₁₆	16 ⁷ / ₈	33 ³ / ₄	17 ³ / ₈	34 ³ / ₄	
	12	12	AUF(†)-12-(*)-VTU12	AUF(†)-12-(*)-VTD12	15 ¹³ / ₁₆	31 ¹¹ / ₁₆	16 ⁵ / ₁₆	32 ⁹ / ₁₆	16 ⁷ / ₈	33 ³ / ₄	17 ³ / ₈	34 ³ / ₄	
	12	18	AUF(†)-18-(*)-VTU12	AUF(†)-18-(*)-VTD12	15 ¹³ / ₁₆	31 ¹¹ / ₁₆	16 ⁵ / ₁₆	32 ⁹ / ₁₆	16 ⁷ / ₈	33 ³ / ₄	17 ³ / ₈	34 ³ / ₄	
	12	24	AUF(†)-24-(*)-VTU12	AUF(†)-24-(*)-VTD12	15 ¹³ / ₁₆	31 ¹¹ / ₁₆	16 ⁵ / ₁₆	32 ⁹ / ₁₆	16 ⁷ / ₈	33 ³ / ₄	17 ³ / ₈	34 ³ / ₄	
	12	30	AUF(†)-30-(*)-VTU12	AUF(†)-30-(*)-VTD12	15 ¹³ / ₁₆	31 ¹¹ / ₁₆	16 ⁵ / ₁₆	32 ⁹ / ₁₆	16 ⁷ / ₈	33 ³ / ₄	17 ³ / ₈	34 ³ / ₄	
	12	36	AUF(†)-36-(*)-VTU12	AUF(†)-36-(*)-VTD12	15 ¹³ / ₁₆	31 ¹¹ / ₁₆	16 ⁵ / ₁₆	32 ⁹ / ₁₆	16 ⁷ / ₈	33 ³ / ₄	17 ³ / ₈	34 ³ / ₄	
	12	42	AUF(†)-42-(*)-VTU12	AUF(†)-42-(*)-VTD12	15 ¹³ / ₁₆	31 ¹¹ / ₁₆	16 ⁵ / ₁₆	32 ⁹ / ₁₆	16 ⁷ / ₈	33 ³ / ₄	17 ³ / ₈	34 ³ / ₄	
		24	6	AUF(†)-06-(*)-VTU24	AUF(†)-06-(*)-VTD24	27 ¹³ / ₁₆	55 ¹¹ / ₁₆	28 ⁵ / ₁₆	56 ⁹ / ₁₆	28 ⁷ / ₈	57 ³ / ₄	29 ³ / ₈	58 ³ / ₄
		24	9	AUF(†)-09-(*)-VTU24	AUF(†)-09-(*)-VTD24	27 ¹³ / ₁₆	55 ¹¹ / ₁₆	28 ⁵ / ₁₆	56 ⁹ / ₁₆	28 ⁷ / ₈	57 ³ / ₄	29 ³ / ₈	58 ³ / ₄
		24	12	AUF(†)-12-(*)-VTU24	AUF(†)-12-(*)-VTD24	27 ¹³ / ₁₆	55 ¹¹ / ₁₆	28 ⁵ / ₁₆	56 ⁹ / ₁₆	28 ⁷ / ₈	57 ³ / ₄	29 ³ / ₈	58 ³ / ₄
		24	18	AUF(†)-18-(*)-VTU24	AUF(†)-18-(*)-VTD24	27 ¹³ / ₁₆	55 ¹¹ / ₁₆	28 ⁵ / ₁₆	56 ⁹ / ₁₆	28 ⁷ / ₈	57 ³ / ₄	29 ³ / ₈	58 ³ / ₄
24		24	AUF(†)-24-(*)-VTU24	AUF(†)-24-(*)-VTD24	27 ¹³ / ₁₆	55 ¹¹ / ₁₆	28 ⁵ / ₁₆	56 ⁹ / ₁₆	28 ⁷ / ₈	57 ³ / ₄	29 ³ / ₈	58 ³ / ₄	
24		30	AUF(†)-30-(*)-VTU24	AUF(†)-30-(*)-VTD24	27 ¹³ / ₁₆	55 ¹¹ / ₁₆	28 ⁵ / ₁₆	56 ⁹ / ₁₆	28 ⁷ / ₈	57 ³ / ₄	29 ³ / ₈	58 ³ / ₄	
24		36	AUF(†)-36-(*)-VTU24	AUF(†)-36-(*)-VTD24	27 ¹³ / ₁₆	55 ¹¹ / ₁₆	28 ⁵ / ₁₆	56 ⁹ / ₁₆	28 ⁷ / ₈	57 ³ / ₄	29 ³ / ₈	58 ³ / ₄	
24		42	AUF(†)-42-(*)-VTU24	AUF(†)-42-(*)-VTD24	27 ¹³ / ₁₆	55 ¹¹ / ₁₆	28 ⁵ / ₁₆	56 ⁹ / ₁₆	28 ⁷ / ₈	57 ³ / ₄	29 ³ / ₈	58 ³ / ₄	
Down 		36	6	AUF(†)-06-(*)-VTU36	AUF(†)-06-(*)-VTD36	39 ¹³ / ₁₆	79 ¹¹ / ₁₆	40 ⁵ / ₁₆	80 ⁹ / ₁₆	40 ⁷ / ₈	81 ³ / ₄	41 ³ / ₈	82 ³ / ₄
		36	9	AUF(†)-09-(*)-VTU36	AUF(†)-09-(*)-VTD36	39 ¹³ / ₁₆	79 ¹¹ / ₁₆	40 ⁵ / ₁₆	80 ⁹ / ₁₆	40 ⁷ / ₈	81 ³ / ₄	41 ³ / ₈	82 ³ / ₄
		36	12	AUF(†)-12-(*)-VTU36	AUF(†)-12-(*)-VTD36	39 ¹³ / ₁₆	79 ¹¹ / ₁₆	40 ⁵ / ₁₆	80 ⁹ / ₁₆	40 ⁷ / ₈	81 ³ / ₄	41 ³ / ₈	82 ³ / ₄
		36	18	AUF(†)-18-(*)-VTU36	AUF(†)-18-(*)-VTD36	39 ¹³ / ₁₆	79 ¹¹ / ₁₆	40 ⁵ / ₁₆	80 ⁹ / ₁₆	40 ⁷ / ₈	81 ³ / ₄	41 ³ / ₈	82 ³ / ₄
	36	24	AUF(†)-24-(*)-VTU36	AUF(†)-24-(*)-VTD36	39 ¹³ / ₁₆	79 ¹¹ / ₁₆	40 ⁵ / ₁₆	80 ⁹ / ₁₆	40 ⁷ / ₈	81 ³ / ₄	41 ³ / ₈	82 ³ / ₄	
	36	30	AUF(†)-30-(*)-VTU36	AUF(†)-30-(*)-VTD36	39 ¹³ / ₁₆	79 ¹¹ / ₁₆	40 ⁵ / ₁₆	80 ⁹ / ₁₆	40 ⁷ / ₈	81 ³ / ₄	41 ³ / ₈	82 ³ / ₄	
	36	36	AUF(†)-36-(*)-VTU36	AUF(†)-36-(*)-VTD36	39 ¹³ / ₁₆	79 ¹¹ / ₁₆	40 ⁵ / ₁₆	80 ⁹ / ₁₆	40 ⁷ / ₈	81 ³ / ₄	41 ³ / ₈	82 ³ / ₄	
	36	42	AUF(†)-42-(*)-VTU36	AUF(†)-42-(*)-VTD36	39 ¹³ / ₁₆	79 ¹¹ / ₁₆	40 ⁵ / ₁₆	80 ⁹ / ₁₆	40 ⁷ / ₈	81 ³ / ₄	41 ³ / ₈	82 ³ / ₄	
		48	6	AUF(†)-06-(*)-VTU48	AUF(†)-06-(*)-VTD48	51 ¹³ / ₁₆	103 ¹¹ / ₁₆	52 ⁵ / ₁₆	104 ⁹ / ₁₆	52 ⁷ / ₈	105 ³ / ₄	53 ³ / ₈	106 ³ / ₄
		48	9	AUF(†)-09-(*)-VTU48	AUF(†)-09-(*)-VTD48	51 ¹³ / ₁₆	103 ¹¹ / ₁₆	52 ⁵ / ₁₆	104 ⁹ / ₁₆	52 ⁷ / ₈	105 ³ / ₄	53 ³ / ₈	106 ³ / ₄
		48	12	AUF(†)-12-(*)-VTU48	AUF(†)-12-(*)-VTD48	51 ¹³ / ₁₆	103 ¹¹ / ₁₆	52 ⁵ / ₁₆	104 ⁹ / ₁₆	52 ⁷ / ₈	105 ³ / ₄	53 ³ / ₈	106 ³ / ₄
		48	18	AUF(†)-18-(*)-VTU48	AUF(†)-18-(*)-VTD48	51 ¹³ / ₁₆	103 ¹¹ / ₁₆	52 ⁵ / ₁₆	104 ⁹ / ₁₆	52 ⁷ / ₈	105 ³ / ₄	53 ³ / ₈	106 ³ / ₄
48		24	AUF(†)-24-(*)-VTU48	AUF(†)-24-(*)-VTD48	51 ¹³ / ₁₆	103 ¹¹ / ₁₆	52 ⁵ / ₁₆	104 ⁹ / ₁₆	52 ⁷ / ₈	105 ³ / ₄	53 ³ / ₈	106 ³ / ₄	
48		30	AUF(†)-30-(*)-VTU48	AUF(†)-30-(*)-VTD48	51 ¹³ / ₁₆	103 ¹¹ / ₁₆	52 ⁵ / ₁₆	104 ⁹ / ₁₆	52 ⁷ / ₈	105 ³ / ₄	53 ³ / ₈	106 ³ / ₄	
48		36	AUF(†)-36-(*)-VTU48	AUF(†)-36-(*)-VTD48	51 ¹³ / ₁₆	103 ¹¹ / ₁₆	52 ⁵ / ₁₆	104 ⁹ / ₁₆	52 ⁷ / ₈	105 ³ / ₄	53 ³ / ₈	106 ³ / ₄	
48		42	AUF(†)-42-(*)-VTU48	AUF(†)-42-(*)-VTD48	51 ¹³ / ₁₆	103 ¹¹ / ₁₆	52 ⁵ / ₁₆	104 ⁹ / ₁₆	52 ⁷ / ₈	105 ³ / ₄	53 ³ / ₈	106 ³ / ₄	

(†) Insert side rail height. (*) Insert bottom style to complete cat. no. Includes 2 pairs of splice plates with hardware.
 T&B aluminum cable tray is composed of two distinct systems, H-style and U-style. These systems are interchangeable.

Part numbering system

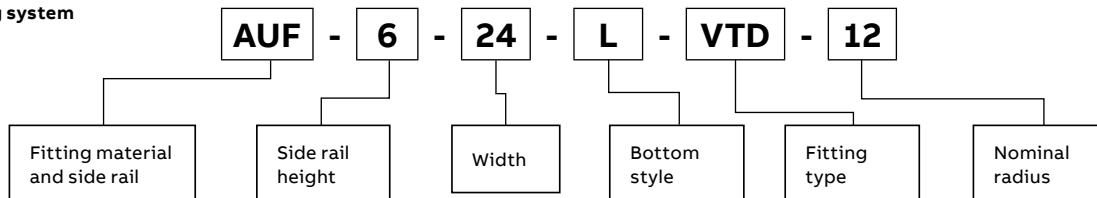



Aluminum fittings

H-style vertical tee up/down fittings

Selection guide

- Inside tray widths: 6, 9, 12, 18, 24, 30, 36, 42 in.
- Nominal radius: 12, 24, 36, 48 in.
- Bottom styles: L- ladder, V- ventilated, S- solid
- Side rail heights: 4-7 in.

Vertical tee up/down - H-style

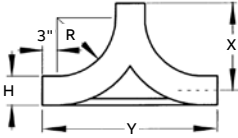
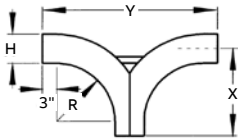
	Nominal Radius	Width	Vertical tee up Cat. no.	Vertical tee down Cat. no.	Side rail height "H"								
					4 in.		5 in.		6 in.		7 in.		
					X	Y	X	Y	X	Y	X	Y	
Up 	12	6	AHF(†)-06-(*)-VTU12	AHF(†)-06-(*)-VTD12	17 ¹ / ₁₆	34 ³ / ₁₆	17 ¹ / ₁₆	35 ¹ / ₁₆	18 ³ / ₈	36 ¹ / ₄	18 ³ / ₈	37 ¹ / ₄	
	12	9	AHF(†)-09-(*)-VTU12	AHF(†)-09-(*)-VTD12	17 ¹ / ₁₆	34 ³ / ₁₆	17 ¹ / ₁₆	35 ¹ / ₁₆	18 ³ / ₈	36 ¹ / ₄	18 ³ / ₈	37 ¹ / ₄	
	12	12	AHF(†)-12-(*)-VTU12	AHF(†)-12-(*)-VTD12	17 ¹ / ₁₆	34 ³ / ₁₆	17 ¹ / ₁₆	35 ¹ / ₁₆	18 ³ / ₈	36 ¹ / ₄	18 ³ / ₈	37 ¹ / ₄	
	12	18	AHF(†)-18-(*)-VTU12	AHF(†)-18-(*)-VTD12	17 ¹ / ₁₆	34 ³ / ₁₆	17 ¹ / ₁₆	35 ¹ / ₁₆	18 ³ / ₈	36 ¹ / ₄	18 ³ / ₈	37 ¹ / ₄	
	12	24	AHF(†)-24-(*)-VTU12	AHF(†)-24-(*)-VTD12	17 ¹ / ₁₆	34 ³ / ₁₆	17 ¹ / ₁₆	35 ¹ / ₁₆	18 ³ / ₈	36 ¹ / ₄	18 ³ / ₈	37 ¹ / ₄	
	12	30	AHF(†)-30-(*)-VTU12	AHF(†)-30-(*)-VTD12	17 ¹ / ₁₆	34 ³ / ₁₆	17 ¹ / ₁₆	35 ¹ / ₁₆	18 ³ / ₈	36 ¹ / ₄	18 ³ / ₈	37 ¹ / ₄	
	12	36	AHF(†)-36-(*)-VTU12	AHF(†)-36-(*)-VTD12	17 ¹ / ₁₆	34 ³ / ₁₆	17 ¹ / ₁₆	35 ¹ / ₁₆	18 ³ / ₈	36 ¹ / ₄	18 ³ / ₈	37 ¹ / ₄	
	12	42	AHF(†)-42-(*)-VTU12	AHF(†)-42-(*)-VTD12	17 ¹ / ₁₆	34 ³ / ₁₆	17 ¹ / ₁₆	35 ¹ / ₁₆	18 ³ / ₈	36 ¹ / ₄	18 ³ / ₈	37 ¹ / ₄	
	Down 	24	6	AHF(†)-06-(*)-VTU24	AHF(†)-06-(*)-VTD24	29 ³ / ₁₆	58 ³ / ₁₆	29 ³ / ₁₆	59 ¹ / ₁₆	30 ³ / ₈	60 ¹ / ₄	30 ³ / ₈	61 ¹ / ₄
		24	9	AHF(†)-09-(*)-VTU24	AHF(†)-09-(*)-VTD24	29 ³ / ₁₆	58 ³ / ₁₆	29 ³ / ₁₆	59 ¹ / ₁₆	30 ³ / ₈	60 ¹ / ₄	30 ³ / ₈	61 ¹ / ₄
		24	12	AHF(†)-12-(*)-VTU24	AHF(†)-12-(*)-VTD24	29 ³ / ₁₆	58 ³ / ₁₆	29 ³ / ₁₆	59 ¹ / ₁₆	30 ³ / ₈	60 ¹ / ₄	30 ³ / ₈	61 ¹ / ₄
		24	18	AHF(†)-18-(*)-VTU24	AHF(†)-18-(*)-VTD24	29 ³ / ₁₆	58 ³ / ₁₆	29 ³ / ₁₆	59 ¹ / ₁₆	30 ³ / ₈	60 ¹ / ₄	30 ³ / ₈	61 ¹ / ₄
24		24	AHF(†)-24-(*)-VTU24	AHF(†)-24-(*)-VTD24	29 ³ / ₁₆	58 ³ / ₁₆	29 ³ / ₁₆	59 ¹ / ₁₆	30 ³ / ₈	60 ¹ / ₄	30 ³ / ₈	61 ¹ / ₄	
24		30	AHF(†)-30-(*)-VTU24	AHF(†)-30-(*)-VTD24	29 ³ / ₁₆	58 ³ / ₁₆	29 ³ / ₁₆	59 ¹ / ₁₆	30 ³ / ₈	60 ¹ / ₄	30 ³ / ₈	61 ¹ / ₄	
24		36	AHF(†)-36-(*)-VTU24	AHF(†)-36-(*)-VTD24	29 ³ / ₁₆	58 ³ / ₁₆	29 ³ / ₁₆	59 ¹ / ₁₆	30 ³ / ₈	60 ¹ / ₄	30 ³ / ₈	61 ¹ / ₄	
24		42	AHF(†)-42-(*)-VTU24	AHF(†)-42-(*)-VTD24	29 ³ / ₁₆	58 ³ / ₁₆	29 ³ / ₁₆	59 ¹ / ₁₆	30 ³ / ₈	60 ¹ / ₄	30 ³ / ₈	61 ¹ / ₄	
Up 		36	6	AHF(†)-06-(*)-VTU36	AHF(†)-06-(*)-VTD36	41 ¹ / ₁₆	82 ³ / ₁₆	41 ¹ / ₁₆	83 ¹ / ₁₆	42 ³ / ₈	84 ¹ / ₄	42 ³ / ₈	85 ¹ / ₄
		36	9	AHF(†)-09-(*)-VTU36	AHF(†)-09-(*)-VTD36	41 ¹ / ₁₆	82 ³ / ₁₆	41 ¹ / ₁₆	83 ¹ / ₁₆	42 ³ / ₈	84 ¹ / ₄	42 ³ / ₈	85 ¹ / ₄
		36	12	AHF(†)-12-(*)-VTU36	AHF(†)-12-(*)-VTD36	41 ¹ / ₁₆	82 ³ / ₁₆	41 ¹ / ₁₆	83 ¹ / ₁₆	42 ³ / ₈	84 ¹ / ₄	42 ³ / ₈	85 ¹ / ₄
		36	18	AHF(†)-18-(*)-VTU36	AHF(†)-18-(*)-VTD36	41 ¹ / ₁₆	82 ³ / ₁₆	41 ¹ / ₁₆	83 ¹ / ₁₆	42 ³ / ₈	84 ¹ / ₄	42 ³ / ₈	85 ¹ / ₄
	36	24	AHF(†)-24-(*)-VTU36	AHF(†)-24-(*)-VTD36	41 ¹ / ₁₆	82 ³ / ₁₆	41 ¹ / ₁₆	83 ¹ / ₁₆	42 ³ / ₈	84 ¹ / ₄	42 ³ / ₈	85 ¹ / ₄	
	36	30	AHF(†)-30-(*)-VTU36	AHF(†)-30-(*)-VTD36	41 ¹ / ₁₆	82 ³ / ₁₆	41 ¹ / ₁₆	83 ¹ / ₁₆	42 ³ / ₈	84 ¹ / ₄	42 ³ / ₈	85 ¹ / ₄	
	36	36	AHF(†)-36-(*)-VTU36	AHF(†)-36-(*)-VTD36	41 ¹ / ₁₆	82 ³ / ₁₆	41 ¹ / ₁₆	83 ¹ / ₁₆	42 ³ / ₈	84 ¹ / ₄	42 ³ / ₈	85 ¹ / ₄	
	36	42	AHF(†)-42-(*)-VTU36	AHF(†)-42-(*)-VTD36	41 ¹ / ₁₆	82 ³ / ₁₆	41 ¹ / ₁₆	83 ¹ / ₁₆	42 ³ / ₈	84 ¹ / ₄	42 ³ / ₈	85 ¹ / ₄	
	Down 	48	6	AHF(†)-06-(*)-VTU48	AHF(†)-06-(*)-VTD48	53 ³ / ₁₆	106 ³ / ₁₆	53 ³ / ₁₆	107 ¹ / ₁₆	54 ³ / ₈	108 ¹ / ₄	54 ³ / ₈	109 ¹ / ₄
		48	9	AHF(†)-09-(*)-VTU48	AHF(†)-09-(*)-VTD48	53 ³ / ₁₆	106 ³ / ₁₆	53 ³ / ₁₆	107 ¹ / ₁₆	54 ³ / ₈	108 ¹ / ₄	54 ³ / ₈	109 ¹ / ₄
		48	12	AHF(†)-12-(*)-VTU48	AHF(†)-12-(*)-VTD48	53 ³ / ₁₆	106 ³ / ₁₆	53 ³ / ₁₆	107 ¹ / ₁₆	54 ³ / ₈	108 ¹ / ₄	54 ³ / ₈	109 ¹ / ₄
		48	18	AHF(†)-18-(*)-VTU48	AHF(†)-18-(*)-VTD48	53 ³ / ₁₆	106 ³ / ₁₆	53 ³ / ₁₆	107 ¹ / ₁₆	54 ³ / ₈	108 ¹ / ₄	54 ³ / ₈	109 ¹ / ₄
48		24	AHF(†)-24-(*)-VTU48	AHF(†)-24-(*)-VTD48	53 ³ / ₁₆	106 ³ / ₁₆	53 ³ / ₁₆	107 ¹ / ₁₆	54 ³ / ₈	108 ¹ / ₄	54 ³ / ₈	109 ¹ / ₄	
48		30	AHF(†)-30-(*)-VTU48	AHF(†)-30-(*)-VTD48	53 ³ / ₁₆	106 ³ / ₁₆	53 ³ / ₁₆	107 ¹ / ₁₆	54 ³ / ₈	108 ¹ / ₄	54 ³ / ₈	109 ¹ / ₄	
48		36	AHF(†)-36-(*)-VTU48	AHF(†)-36-(*)-VTD48	53 ³ / ₁₆	106 ³ / ₁₆	53 ³ / ₁₆	107 ¹ / ₁₆	54 ³ / ₈	108 ¹ / ₄	54 ³ / ₈	109 ¹ / ₄	
48		42	AHF(†)-42-(*)-VTU48	AHF(†)-42-(*)-VTD48	53 ³ / ₁₆	106 ³ / ₁₆	53 ³ / ₁₆	107 ¹ / ₁₆	54 ³ / ₈	108 ¹ / ₄	54 ³ / ₈	109 ¹ / ₄	

(†) Insert side rail height. (*) Insert bottom style to complete cat. no. Includes 2 pairs of splice plates with hardware.
 T&B aluminum cable tray is composed of two distinct systems, H-style and U-style. These systems are interchangeable.

Part numbering system

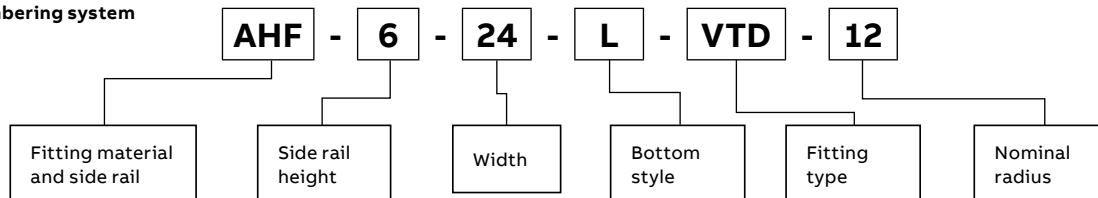

Aluminum fittings

U-style cable support fittings

Selection guide

- Inside tray widths: 6, 9, 12, 18, 24, 30, 36, 42 in.
- Nominal radius: 12, 24, 36, 48 in.
- Bottom styles: L- ladder, V- ventilated, S- solid
- Side rail heights: 4-7 in.

Cable support fitting – U-style

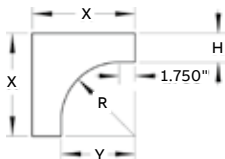

Nominal			Dimensions (in.)												
			4 in.				5 in.				6 in.				7 in.
Radius (in.)	Width (in.)	Cat. no.	X	Y	X	Y	X	Y	X	Y	X	Y	X	Y	
12	6	AUF(†)-06-(*)-CS12	17 ¹⁵ / ₁₆	13 ³ / ₄	18 ¹³ / ₁₆	13 ³ / ₄	20	13 ³ / ₄	21	13 ³ / ₄	21	13 ³ / ₄	21	13 ³ / ₄	
12	9	AUF(†)-09-(*)-CS12	17 ¹⁵ / ₁₆	13 ³ / ₄	18 ¹³ / ₁₆	13 ³ / ₄	20	13 ³ / ₄	21	13 ³ / ₄	21	13 ³ / ₄	21	13 ³ / ₄	
12	12	AUF(†)-12-(*)-CS12	17 ¹⁵ / ₁₆	13 ³ / ₄	18 ¹³ / ₁₆	13 ³ / ₄	20	13 ³ / ₄	21	13 ³ / ₄	21	13 ³ / ₄	21	13 ³ / ₄	
12	18	AUF(†)-18-(*)-CS12	17 ¹⁵ / ₁₆	13 ³ / ₄	18 ¹³ / ₁₆	13 ³ / ₄	20	13 ³ / ₄	21	13 ³ / ₄	21	13 ³ / ₄	21	13 ³ / ₄	
12	24	AUF(†)-24-(*)-CS12	17 ¹⁵ / ₁₆	13 ³ / ₄	18 ¹³ / ₁₆	13 ³ / ₄	20	13 ³ / ₄	21	13 ³ / ₄	21	13 ³ / ₄	21	13 ³ / ₄	
12	30	AUF(†)-30-(*)-CS12	17 ¹⁵ / ₁₆	13 ³ / ₄	18 ¹³ / ₁₆	13 ³ / ₄	20	13 ³ / ₄	21	13 ³ / ₄	21	13 ³ / ₄	21	13 ³ / ₄	
12	36	AUF(†)-36-(*)-CS12	17 ¹⁵ / ₁₆	13 ³ / ₄	18 ¹³ / ₁₆	13 ³ / ₄	20	13 ³ / ₄	21	13 ³ / ₄	21	13 ³ / ₄	21	13 ³ / ₄	
12	42	AUF(†)-42-(*)-CS12	17 ¹⁵ / ₁₆	13 ³ / ₄	18 ¹³ / ₁₆	13 ³ / ₄	20	13 ³ / ₄	21	13 ³ / ₄	21	13 ³ / ₄	21	13 ³ / ₄	
24	6	AUF(†)-06-(*)-CS24	29 ¹⁵ / ₁₆	25 ³ / ₄	30 ¹³ / ₁₆	25 ³ / ₄	32	25 ³ / ₄	33	25 ³ / ₄	33	25 ³ / ₄	33	25 ³ / ₄	
24	9	AUF(†)-09-(*)-CS24	29 ¹⁵ / ₁₆	25 ³ / ₄	30 ¹³ / ₁₆	25 ³ / ₄	32	25 ³ / ₄	33	25 ³ / ₄	33	25 ³ / ₄	33	25 ³ / ₄	
24	12	AUF(†)-12-(*)-CS24	29 ¹⁵ / ₁₆	25 ³ / ₄	30 ¹³ / ₁₆	25 ³ / ₄	32	25 ³ / ₄	33	25 ³ / ₄	33	25 ³ / ₄	33	25 ³ / ₄	
24	18	AUF(†)-18-(*)-CS24	29 ¹⁵ / ₁₆	25 ³ / ₄	30 ¹³ / ₁₆	25 ³ / ₄	32	25 ³ / ₄	33	25 ³ / ₄	33	25 ³ / ₄	33	25 ³ / ₄	
24	24	AUF(†)-24-(*)-CS24	29 ¹⁵ / ₁₆	25 ³ / ₄	30 ¹³ / ₁₆	25 ³ / ₄	32	25 ³ / ₄	33	25 ³ / ₄	33	25 ³ / ₄	33	25 ³ / ₄	
24	30	AUF(†)-30-(*)-CS24	29 ¹⁵ / ₁₆	25 ³ / ₄	30 ¹³ / ₁₆	25 ³ / ₄	32	25 ³ / ₄	33	25 ³ / ₄	33	25 ³ / ₄	33	25 ³ / ₄	
24	36	AUF(†)-36-(*)-CS24	29 ¹⁵ / ₁₆	25 ³ / ₄	30 ¹³ / ₁₆	25 ³ / ₄	32	25 ³ / ₄	33	25 ³ / ₄	33	25 ³ / ₄	33	25 ³ / ₄	
24	42	AUF(†)-42-(*)-CS24	29 ¹⁵ / ₁₆	25 ³ / ₄	30 ¹³ / ₁₆	25 ³ / ₄	32	25 ³ / ₄	33	25 ³ / ₄	33	25 ³ / ₄	33	25 ³ / ₄	
36	6	AUF(†)-06-(*)-CS36	41 ¹⁵ / ₁₆	37 ³ / ₄	42 ¹³ / ₁₆	37 ³ / ₄	44	37 ³ / ₄	45	37 ³ / ₄	45	37 ³ / ₄	45	37 ³ / ₄	
36	9	AUF(†)-09-(*)-CS36	41 ¹⁵ / ₁₆	37 ³ / ₄	42 ¹³ / ₁₆	37 ³ / ₄	44	37 ³ / ₄	45	37 ³ / ₄	45	37 ³ / ₄	45	37 ³ / ₄	
36	12	AUF(†)-12-(*)-CS36	41 ¹⁵ / ₁₆	37 ³ / ₄	42 ¹³ / ₁₆	37 ³ / ₄	44	37 ³ / ₄	45	37 ³ / ₄	45	37 ³ / ₄	45	37 ³ / ₄	
36	18	AUF(†)-18-(*)-CS36	41 ¹⁵ / ₁₆	37 ³ / ₄	42 ¹³ / ₁₆	37 ³ / ₄	44	37 ³ / ₄	45	37 ³ / ₄	45	37 ³ / ₄	45	37 ³ / ₄	
36	24	AUF(†)-24-(*)-CS36	41 ¹⁵ / ₁₆	37 ³ / ₄	42 ¹³ / ₁₆	37 ³ / ₄	44	37 ³ / ₄	45	37 ³ / ₄	45	37 ³ / ₄	45	37 ³ / ₄	
36	30	AUF(†)-30-(*)-CS36	41 ¹⁵ / ₁₆	37 ³ / ₄	42 ¹³ / ₁₆	37 ³ / ₄	44	37 ³ / ₄	45	37 ³ / ₄	45	37 ³ / ₄	45	37 ³ / ₄	
36	36	AUF(†)-36-(*)-CS36	41 ¹⁵ / ₁₆	37 ³ / ₄	42 ¹³ / ₁₆	37 ³ / ₄	44	37 ³ / ₄	45	37 ³ / ₄	45	37 ³ / ₄	45	37 ³ / ₄	
36	42	AUF(†)-42-(*)-CS36	41 ¹⁵ / ₁₆	37 ³ / ₄	42 ¹³ / ₁₆	37 ³ / ₄	44	37 ³ / ₄	45	37 ³ / ₄	45	37 ³ / ₄	45	37 ³ / ₄	
48	6	AUF(†)-06-(*)-CS48	53 ¹⁵ / ₁₆	49 ³ / ₄	54 ¹³ / ₁₆	49 ³ / ₄	56	49 ³ / ₄	57	49 ³ / ₄	57	49 ³ / ₄	57	49 ³ / ₄	
48	9	AUF(†)-09-(*)-CS48	53 ¹⁵ / ₁₆	49 ³ / ₄	54 ¹³ / ₁₆	49 ³ / ₄	56	49 ³ / ₄	57	49 ³ / ₄	57	49 ³ / ₄	57	49 ³ / ₄	
48	12	AUF(†)-12-(*)-CS48	53 ¹⁵ / ₁₆	49 ³ / ₄	54 ¹³ / ₁₆	49 ³ / ₄	56	49 ³ / ₄	57	49 ³ / ₄	57	49 ³ / ₄	57	49 ³ / ₄	
48	18	AUF(†)-18-(*)-CS48	53 ¹⁵ / ₁₆	49 ³ / ₄	54 ¹³ / ₁₆	49 ³ / ₄	56	49 ³ / ₄	57	49 ³ / ₄	57	49 ³ / ₄	57	49 ³ / ₄	
48	24	AUF(†)-24-(*)-CS48	53 ¹⁵ / ₁₆	49 ³ / ₄	54 ¹³ / ₁₆	49 ³ / ₄	56	49 ³ / ₄	57	49 ³ / ₄	57	49 ³ / ₄	57	49 ³ / ₄	
48	30	AUF(†)-30-(*)-CS48	53 ¹⁵ / ₁₆	49 ³ / ₄	54 ¹³ / ₁₆	49 ³ / ₄	56	49 ³ / ₄	57	49 ³ / ₄	57	49 ³ / ₄	57	49 ³ / ₄	
48	36	AUF(†)-36-(*)-CS48	53 ¹⁵ / ₁₆	49 ³ / ₄	54 ¹³ / ₁₆	49 ³ / ₄	56	49 ³ / ₄	57	49 ³ / ₄	57	49 ³ / ₄	57	49 ³ / ₄	
48	42	AUF(†)-42-(*)-CS48	53 ¹⁵ / ₁₆	49 ³ / ₄	54 ¹³ / ₁₆	49 ³ / ₄	56	49 ³ / ₄	57	49 ³ / ₄	57	49 ³ / ₄	57	49 ³ / ₄	

(†) Insert side rail height. (*) Insert bottom style to complete cat. no. Includes 1 pair of splice plates with hardware.
 T&B aluminum cable tray is composed of two distinct systems, H-style and U-style. These systems are interchangeable.

Part numbering system

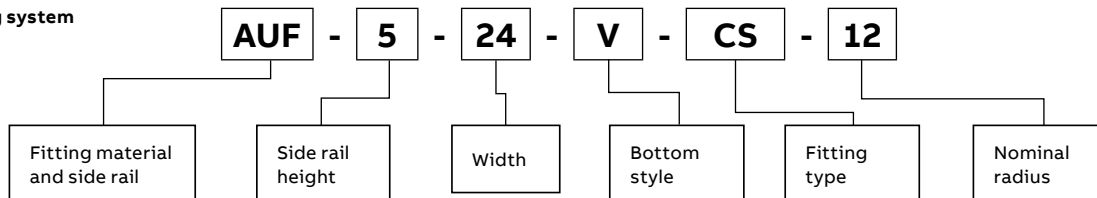

Aluminum fittings

H-style cable support fittings

Selection guide

- Inside tray widths: 6, 9, 12, 18, 24, 30, 36, 42 in.
- Nominal radius: 12, 24, 36, 48 in.
- Bottom styles: L– ladder, V– ventilated, S– solid
- Side rail heights: 4–7 in.

Cable support fitting – H-style

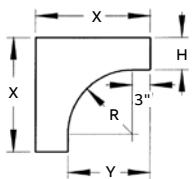

Nominal Radius (in.)	Width (in.)	Cat. no.	Dimensions (in.)							
			4 in.				5 in.			
			X	Y	X	Y	X	Y	X	Y
Side rail height "H"										
			6 in.		7 in.					
			X	Y	X	Y	X	Y	X	Y
12	6	AHF(†)-06-(*)-CS12	19 ³ / ₁₆	15	20 ¹ / ₁₆	15	21 ¹ / ₄	15	22 ³ / ₄	15
12	9	AHF(†)-09-(*)-CS12	19 ³ / ₁₆	15	20 ¹ / ₁₆	15	21 ¹ / ₄	15	22 ³ / ₄	15
12	12	AHF(†)-12-(*)-CS12	19 ³ / ₁₆	15	20 ¹ / ₁₆	15	21 ¹ / ₄	15	22 ³ / ₄	15
12	18	AHF(†)-18-(*)-CS12	19 ³ / ₁₆	15	20 ¹ / ₁₆	15	21 ¹ / ₄	15	22 ³ / ₄	15
12	24	AHF(†)-24-(*)-CS12	19 ³ / ₁₆	15	20 ¹ / ₁₆	15	21 ¹ / ₄	15	22 ³ / ₄	15
12	30	AHF(†)-30-(*)-CS12	19 ³ / ₁₆	15	20 ¹ / ₁₆	15	21 ¹ / ₄	15	22 ³ / ₄	15
12	36	AHF(†)-36-(*)-CS12	19 ³ / ₁₆	15	20 ¹ / ₁₆	15	21 ¹ / ₄	15	22 ³ / ₄	15
12	42	AHF(†)-42-(*)-CS12	19 ³ / ₁₆	15	20 ¹ / ₁₆	15	21 ¹ / ₄	15	22 ³ / ₄	15
24	6	AHF(†)-06-(*)-CS24	31 ³ / ₁₆	27	32 ¹ / ₁₆	27	33 ³ / ₄	27	34 ³ / ₄	27
24	9	AHF(†)-09-(*)-CS24	31 ³ / ₁₆	27	32 ¹ / ₁₆	27	33 ³ / ₄	27	34 ³ / ₄	27
24	12	AHF(†)-12-(*)-CS24	31 ³ / ₁₆	27	32 ¹ / ₁₆	27	33 ³ / ₄	27	34 ³ / ₄	27
24	18	AHF(†)-18-(*)-CS24	31 ³ / ₁₆	27	32 ¹ / ₁₆	27	33 ³ / ₄	27	34 ³ / ₄	27
24	24	AHF(†)-24-(*)-CS24	31 ³ / ₁₆	27	32 ¹ / ₁₆	27	33 ³ / ₄	27	34 ³ / ₄	27
24	30	AHF(†)-30-(*)-CS24	31 ³ / ₁₆	27	32 ¹ / ₁₆	27	33 ³ / ₄	27	34 ³ / ₄	27
24	36	AHF(†)-36-(*)-CS24	31 ³ / ₁₆	27	32 ¹ / ₁₆	27	33 ³ / ₄	27	34 ³ / ₄	27
24	42	AHF(†)-42-(*)-CS24	31 ³ / ₁₆	27	32 ¹ / ₁₆	27	33 ³ / ₄	27	34 ³ / ₄	27
36	6	AHF(†)-06-(*)-CS36	43 ³ / ₁₆	39	44 ¹ / ₁₆	39	45 ¹ / ₄	39	46 ¹ / ₄	39
36	9	AHF(†)-09-(*)-CS36	43 ³ / ₁₆	39	44 ¹ / ₁₆	39	45 ¹ / ₄	39	46 ¹ / ₄	39
36	12	AHF(†)-12-(*)-CS36	43 ³ / ₁₆	39	44 ¹ / ₁₆	39	45 ¹ / ₄	39	46 ¹ / ₄	39
36	18	AHF(†)-18-(*)-CS36	43 ³ / ₁₆	39	44 ¹ / ₁₆	39	45 ¹ / ₄	39	46 ¹ / ₄	39
36	24	AHF(†)-24-(*)-CS36	43 ³ / ₁₆	39	44 ¹ / ₁₆	39	45 ¹ / ₄	39	46 ¹ / ₄	39
36	30	AHF(†)-30-(*)-CS36	43 ³ / ₁₆	39	44 ¹ / ₁₆	39	45 ¹ / ₄	39	46 ¹ / ₄	39
36	36	AHF(†)-36-(*)-CS36	43 ³ / ₁₆	39	44 ¹ / ₁₆	39	45 ¹ / ₄	39	46 ¹ / ₄	39
36	42	AHF(†)-42-(*)-CS36	43 ³ / ₁₆	39	44 ¹ / ₁₆	39	45 ¹ / ₄	39	46 ¹ / ₄	39
48	6	AHF(†)-06-(*)-CS48	55 ³ / ₁₆	51	56 ¹ / ₁₆	51	57 ¹ / ₄	51	58 ¹ / ₄	51
48	9	AHF(†)-09-(*)-CS48	55 ³ / ₁₆	51	56 ¹ / ₁₆	51	57 ¹ / ₄	51	58 ¹ / ₄	51
48	12	AHF(†)-12-(*)-CS48	55 ³ / ₁₆	51	56 ¹ / ₁₆	51	57 ¹ / ₄	51	58 ¹ / ₄	51
48	18	AHF(†)-18-(*)-CS48	55 ³ / ₁₆	51	56 ¹ / ₁₆	51	57 ¹ / ₄	51	58 ¹ / ₄	51
48	24	AHF(†)-24-(*)-CS48	55 ³ / ₁₆	51	56 ¹ / ₁₆	51	57 ¹ / ₄	51	58 ¹ / ₄	51
48	30	AHF(†)-30-(*)-CS48	55 ³ / ₁₆	51	56 ¹ / ₁₆	51	57 ¹ / ₄	51	58 ¹ / ₄	51
48	36	AHF(†)-36-(*)-CS48	55 ³ / ₁₆	51	56 ¹ / ₁₆	51	57 ¹ / ₄	51	58 ¹ / ₄	51
48	42	AHF(†)-42-(*)-CS48	55 ³ / ₁₆	51	56 ¹ / ₁₆	51	57 ¹ / ₄	51	58 ¹ / ₄	51

(†) Insert side rail height. (*) Insert bottom style to complete cat. no. Includes 1 pair of splice plates with hardware. T&B aluminum cable tray is composed of two distinct systems, H-style and U-style. These systems are interchangeable.

Part numbering system

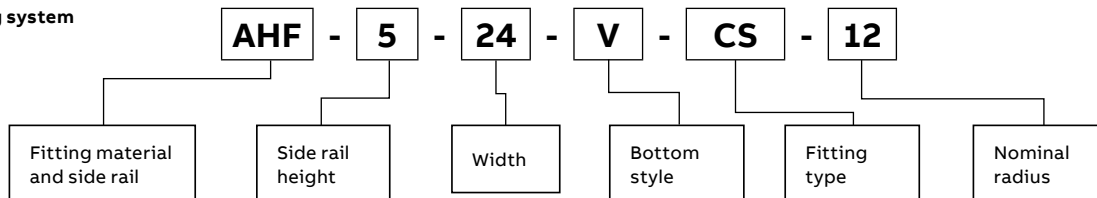

Aluminum fittings

Helix[®] cable tray fitting

—
01 Right-turn assembly
—
02 Left-turn assembly

—
The Helix cable tray fitting.
Efficiency is in its DNA.

Go from horizontal to vertical, maximum cable protection, minimum space.

Making transitions from horizontal to vertical cable tray runs has never been easier or more efficient.

The latest evolution in cable tray fittings, the Helix fitting assembly was developed specifically for use in confined areas. It allows installers to transition from horizontal to vertical surfaces in less time, using significantly less space.

- Enables installation close to walls and other surfaces, eliminating need for distance
- Provides enhanced cable protection in confined spaces
- Secures cables within fitting for clean, organized cable runs

—
Helix cable tray fitting

Cat. no.	Material	Side rail (in.)	Width (in.)	Direction
AUF612LHVR	Aluminum	6	12	Right turn
AUF612LHVL	Aluminum	6	12	Left turn
AUF624LHVR	Aluminum	6	24	Right turn
AUF624LHVL	Aluminum	6	24	Left turn

Supports should be positioned within 24" (610 mm) of each Helix fitting extremity.

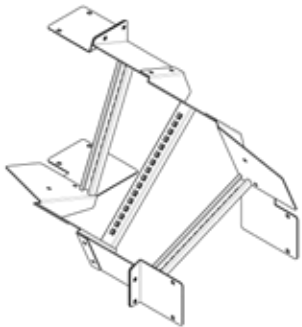

—
01

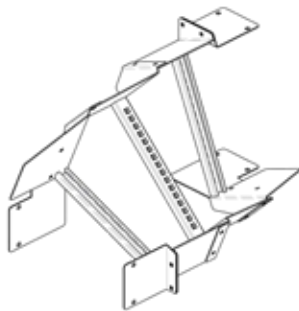

—
02



Aluminum

Large radius aluminum cable tray

Large radius aluminum cable tray

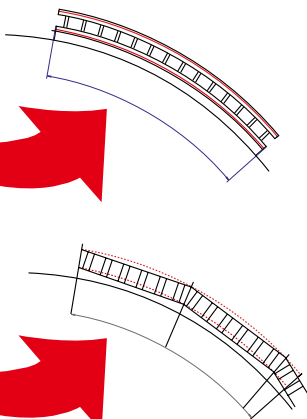
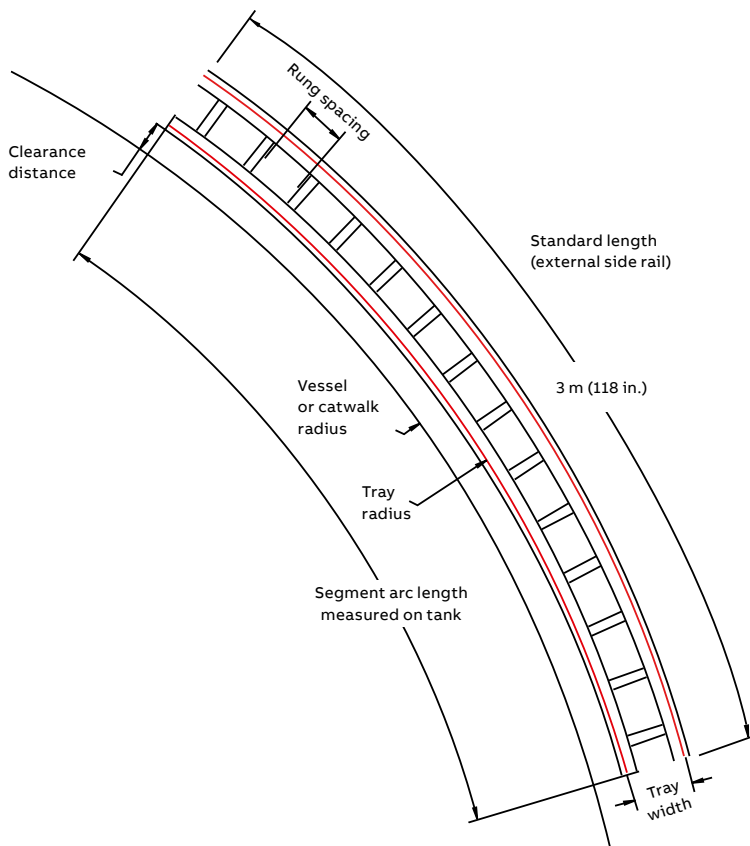

Old method

This cable tray design offers a custom-built cable support system for each petrochemical project tank or tower. This cable tray system is usually installed around the outer perimeter of the catwalks and stairs that are mounted on the tank or vessel.

ABB takes pride in manufacturing a complete system to meet your most rigorous requirements. Our cable support systems reduce the costly and labor-intensive modifications required to assemble straight sections, splice plates and accessories to fit your tank or vessel.

T&B large radius aluminum cable tray systems mount flawlessly with no extra cutting, set-up or surplus material. With the option of pre-assembly of this cable tray system prior to erection of the tank or vessel, you can drastically reduce installing time.

ABB aluminum cable tray is composed of two distinct systems, H-style and U-style. These systems are interchangeable.

Features and benefits

- No mitered joints
- No bent splice plates
- Less costly
- Easier to install
- Faster to install
- Fewer skills required to install
- Cleaner lines
- Improved functionality and aesthetics

Data required for quotation

Height of the cable tray: in.

Width of the cable tray: in.

Rung spacing: in.

Load rating and support span: lb/ft. (kg/m)

Radius of tank or vessel: in.

Clearance distance: in.

Quantity required: (number of segments)

or total arc length: (measured on structure)

Aluminum Tray covers

- 01 Solid cover, flanged
- 02 Solid cover, unflanged
- 03 Ventilated flanged covers
- 04 Peaked flanged cover

Number selection

Tray covers

Tray covers are available for all classes of tray. They should be installed where falling objects may damage cables or where vertical tray run is accessible by pedestrian or vehicular traffic.

Solid covers

These covers provide maximum mechanical protection for cables with limited heat build-up. Solid covers are available with or without flange. Flanged covers have ½ in. flange.

Ventilated flanged covers

This design offers excellent mechanical protection while allowing heat produced by cables to dissipate.

For extreme applications: Peaked flanged covers, peaked ventilated covers

Peaked covers offer mechanical protection and reduce pooling of liquids on the cover.

Cover mounting hardware must be ordered separately.

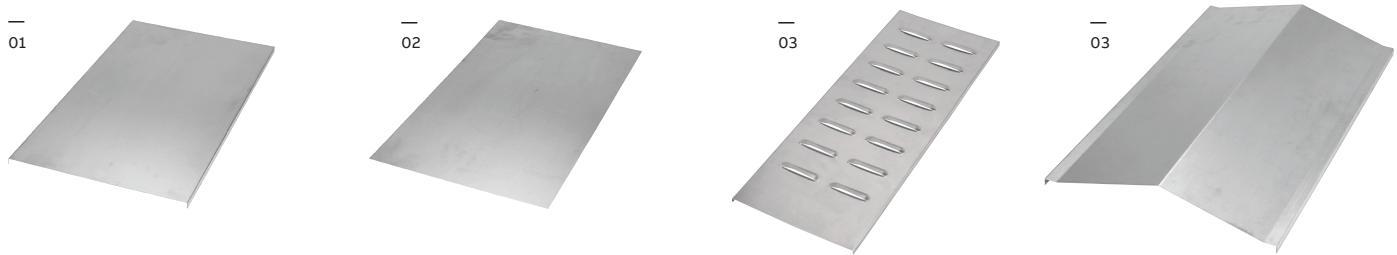

Straight cover number selection

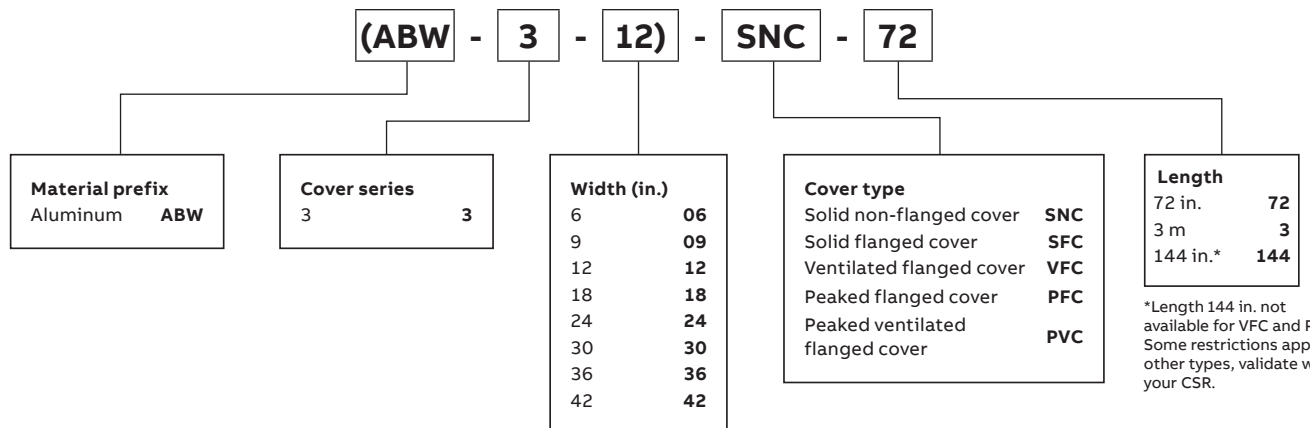

Aluminum

Fittings covers

Fitting covers number selection

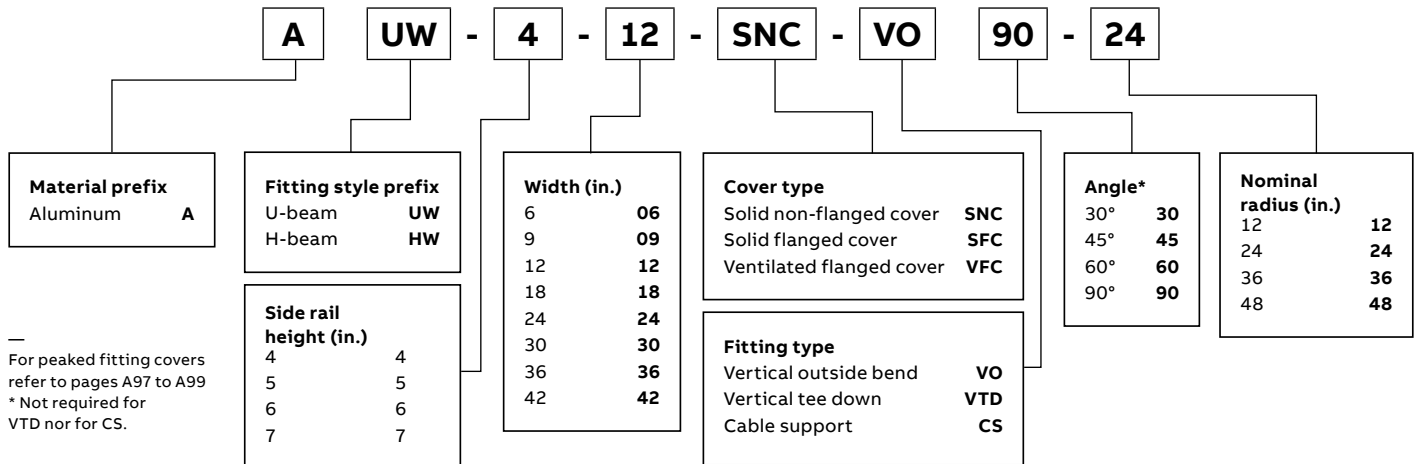
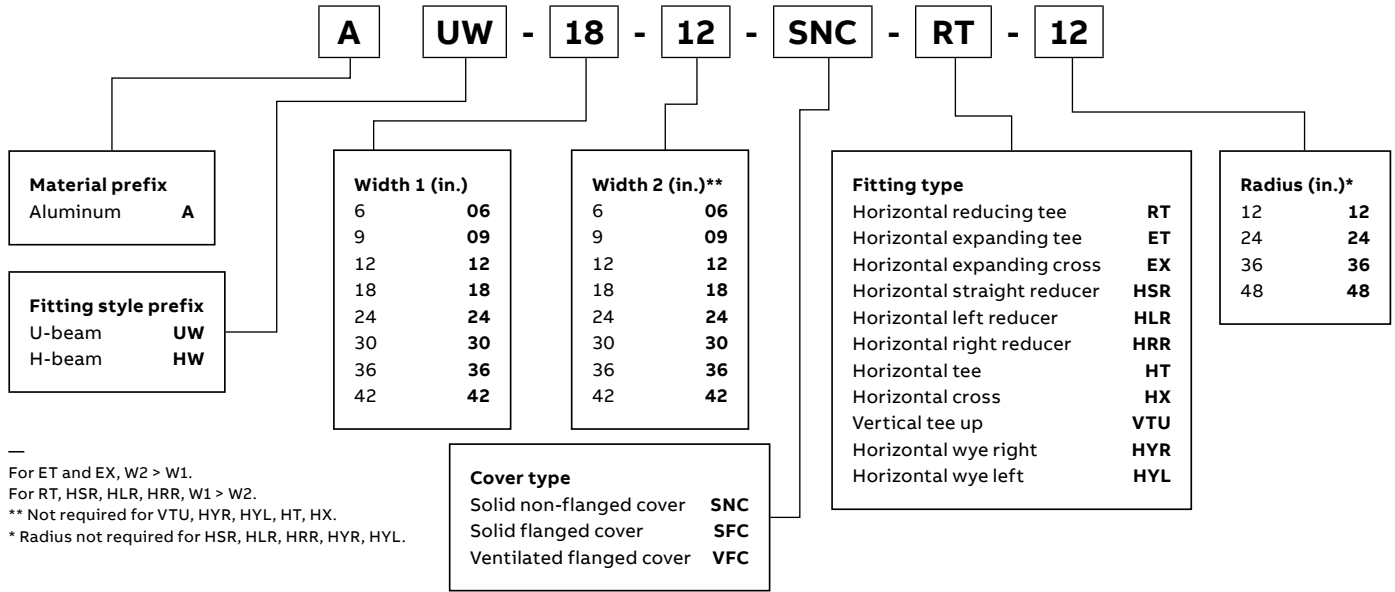
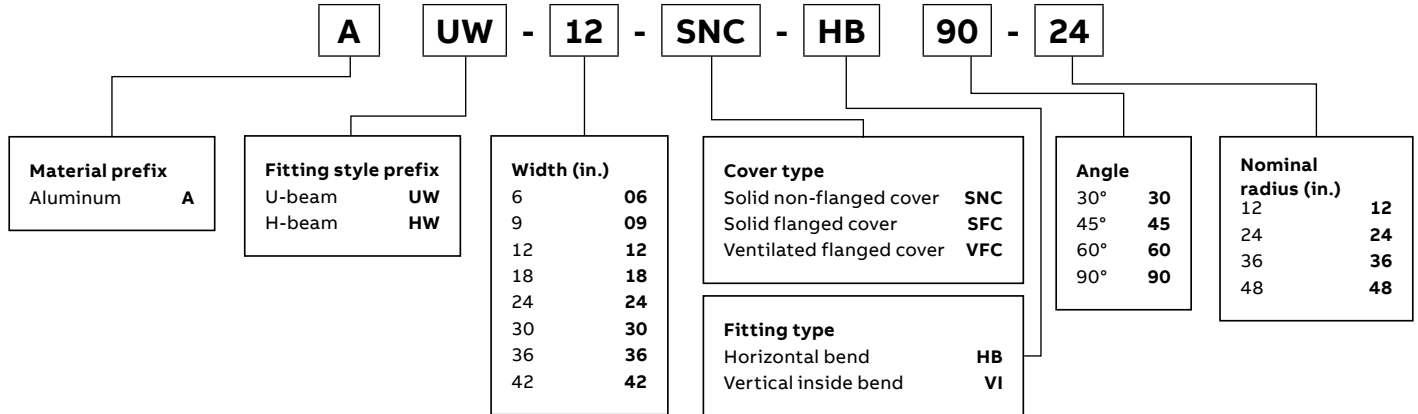

Aluminum

Peaked covers

Horizontal bend/vertical inside bend (peaked covers) number selection



—
Pregalvanized
not available

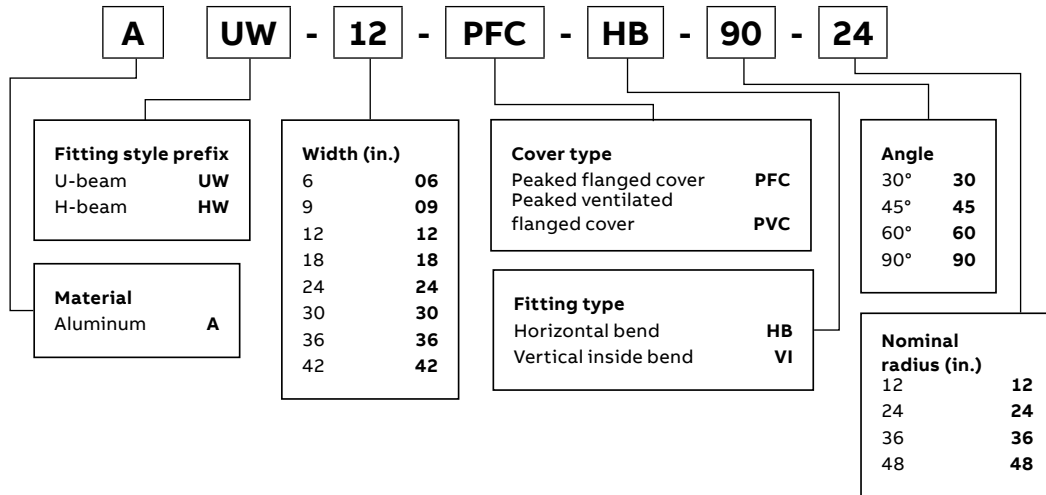

Vertical outside bend (peaked covers) number selection



—
Pregalvanized
not available

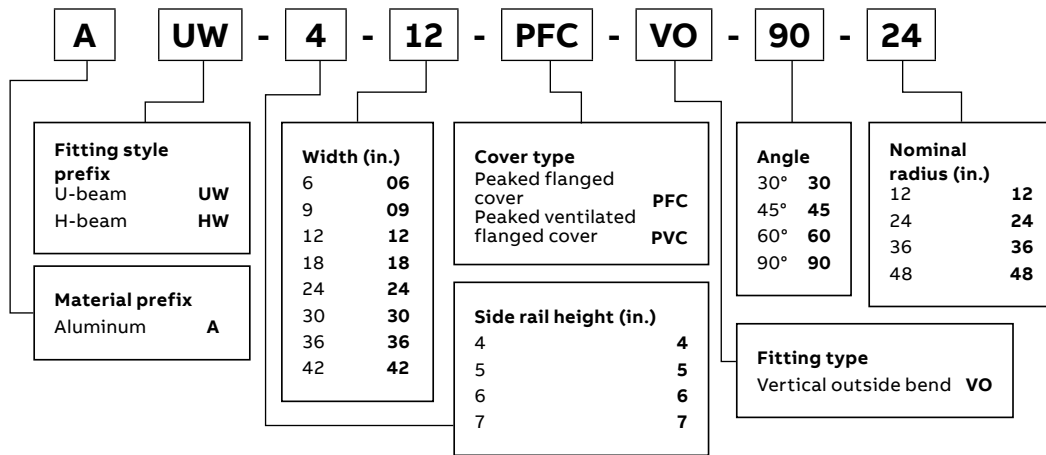

Horizontal tee (peaked covers) number selection



—
Pregalvanized
not available

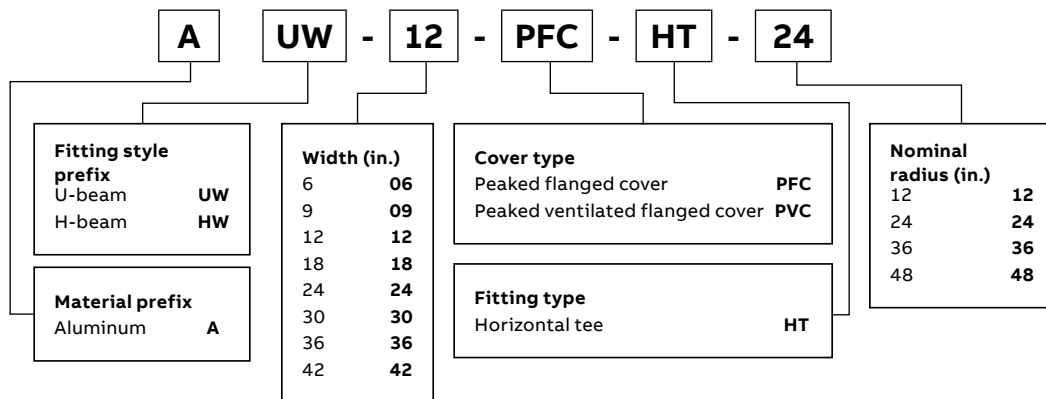

Aluminum covers

Accessories

Quantity of standard cover clamps required

Straight sections 1.8 m (6 ft.)	4 pcs.	Tees	6 pcs.
Straight sections 3 m (10 ft.) and 3.7 m (12 ft.)	6 pcs.	Crosses	8 pcs.
Horizontal and vertical bends	4 pcs.		

Important note: "B" in cat. no. indicates this accessory can be used for both styles.
When using heavy-duty cover clamp, only half the quantity of pieces are required.

Economical cover clamp

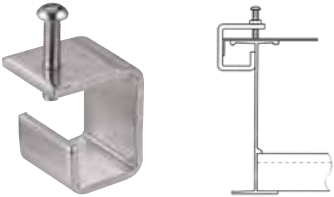
	Cat. no.	Application	Side rail height (in.)
	ABW-SCC	For use with aluminum covers	All sizes

Rigid indoor cover clamp for flat and flanged covers.
Cannot be used with U-style fittings.

Universal fitting cover clamp

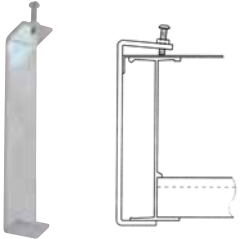
	Cat. no.	Application	Side rail height (in.)
	ABW(*)FCC	For use with aluminum covers	4
		For use with aluminum covers	5
		For use with aluminum covers	6
		For use with aluminum covers	7

Rigid indoor cover clamp for flat and flanged covers.

(*) Insert side rail height

- Side rail heights: 4, 5, 6, 7 in.
- Tray widths: 06, 09, 12, 18, 24, 30, 36, 42 in.

Heavy-duty cover clamp

	Cat. no.	Material	Side rail height	Tray width (in.)
	ABW(**)HCC	Aluminum	4 to 7	06 to 42

Wraparound design offers added protection for rugged applications and outdoor conditions. Hardware included.

(*) Insert side rail height

(**) Insert tray width

- Side rail heights: 4, 5, 6, 7 in.
- Tray widths: 06, 09, 12, 18, 24, 30, 36, 42 in.

Extreme heavy-duty cover clamp

	Cat. no.	Material	Side rail height	Tray width (in.)
	ABW(*)(**)ECC	Aluminum	4 to 7	06 to 42

Wraparound design offers added protection for rugged applications and outdoor conditions. Hardware included.

(*) Insert side rail height

(**) Insert tray width

- Side rail heights: 4, 5, 6, 7 in.
- Tray widths: 06, 09, 12, 18, 24, 30, 36, 42 in.

Heavy-duty peaked cover clamp

	Cat. no.	Material	Side rail height	Tray width (in.)
	ABW(*)(**)HPC	Aluminum	4 to 7	06 to 42

Wraparound design formed to fit peaked cover for outdoor applications. Hardware included.

(*) Insert side rail height

(**) Insert tray width

Hold-down clamp

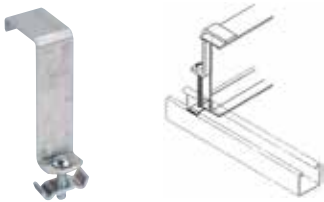
	Cat. no.	Material	Side rail height (in.)
	ABW(*)HDC	Aluminum	4
		Aluminum	5
		Aluminum	6
		Aluminum	7

Designed to secure cable tray to support system. Hardware included.

(*) Insert side rail height

Aluminum covers

Accessories

Raised cover clamp

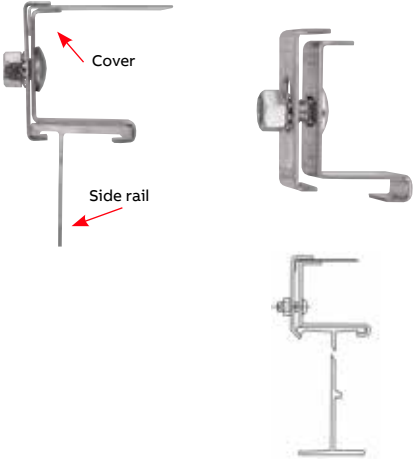
	Cat. no.	Application	Cover series	Cover offset (in.)*
	ABW3(*)RCC†	For use with aluminum covers	3	1
		For use with aluminum covers	3	2
		For use with aluminum covers	3	3
		For use with aluminum covers	3	4

(*) Cover offset. For straight section and PFC and SFC covers only.
Designed to raise cover above tray for added ventilation.

† For indoor applications only.

Peaked end cap

	Cat. no.	Material	Tray width (in.)
	ABW(*)PEC	Aluminum	06
		Aluminum	09
		Aluminum	12
		Aluminum	18
		Aluminum	24
		Aluminum	30
		Aluminum	36
		Aluminum	42

(*) Insert tray width. Used for transition between peaked covers to straight covers.

Cover joint strip

	Cat. no.	Material	Tray width (in.)
	ABW(*)PCS	Plastic	06
		Plastic	09
		Plastic	12
		Plastic	18
		Plastic	24
		Plastic	30
		Plastic	36
		Plastic	42

(*) Insert tray width.

Strip used for joining flat covers end to end.

Aluminum splice plates

Snap-in and transition plates



- Designed to lock into place for easy alignment and installation
- Packaged in pairs with zinc-plated hardware
- Kit contents: 8 bolts, 8 nuts
- Provided as standard with each straight and fitting

Snap-in splice plate

Cat. no.	Material	Side rail height (in.)
ABW-4-SSP	Aluminum	4
ABW-5-SSP	Aluminum	5
ABW-6-SSP	Aluminum	6
ABW-7-SSP	Aluminum	7



- Allows for a 1 in. expansion or contraction of tray system
- Packaged in pairs with zinc-plated hardware
- Kit contents: 8 bolts, 4 nuts, 4 stop nuts $\frac{3}{8}$ in. diameter

Snap-in expansion splice plate

Cat. no.	Material	Side rail height (in.)
ABW-4-ESP	Aluminum	4
ABW-5-ESP	Aluminum	5
ABW-6-ESP	Aluminum	6
ABW-7-ESP	Aluminum	7

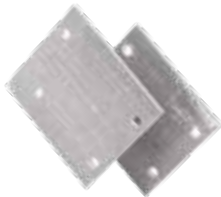

- Designed to make the transition from aluminum to steel cable tray
- Works for all 6 in. side rails

Transition splice plate

Cat. no.	Material	Side rail height (in.)
XNM-XP400-(*)-SS6	Polyester/fiberglass	6

Each pair of plates:
 8 x carriage bolt ($\frac{3}{8}$ x 1 in.) SS316
 8 x $\frac{3}{8}$ in. serrated flange nut SS316

Aluminum splice plates

Horizontal and vertical bend plates - Flexible coupler

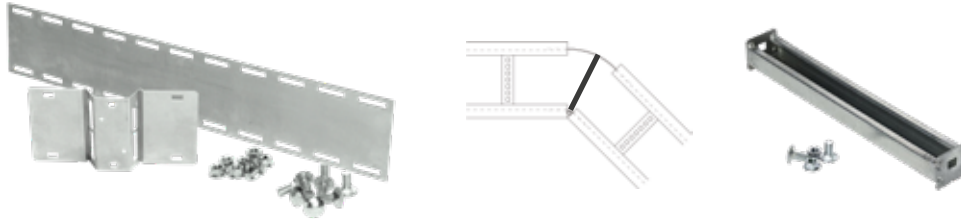

Horizontal bend plate



Cat. no.	Material	Side rail height (in.)	Tray width (in.)
ABW-(*)06HBP	Aluminum	4 to 7	06
ABW-(*)09HBP	Aluminum	4 to 7	09
ABW-(*)12HBP	Aluminum	4 to 7	12
ABW-(*)18HBP	Aluminum	4 to 7	18
ABW-(*)24HBP	Aluminum	4 to 7	24
ABW-(*)30HBP	Aluminum	4 to 7	30
ABW-(*)36HBP	Aluminum	4 to 7	36

Furnished in pairs with hardware.
 (*) Insert side rail height.

Optional rung information (provides additional cable support)

Cat. no.	Material	Tray width (in.)
ABW-R(*)HBP	Aluminum	06
	Aluminum	09
	Aluminum	12
	Aluminum	18
	Aluminum	24
	Aluminum	30
	Aluminum	36

* Insert tray width

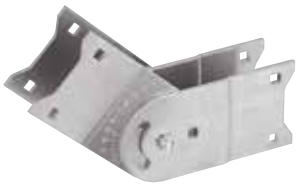

- Hinged vertical plates provide maximum flexibility for changes in elevation
- Furnished in pairs with hardware
- Kit contents: 10 carriage bolts, 2 cap screws, 12 serrated flange nuts, 3/8 in. diameter

Vertical bend plate

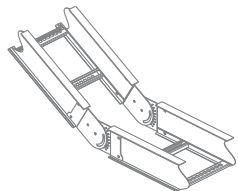

Cat. no.	Material	Side rail height (in.)
ABW-4-VSP	Aluminum	4
ABW-5-VSP	Aluminum	5
ABW-6-VSP	Aluminum	6
ABW-7-VSP	Aluminum	7

Aluminum splice plates

Branch pivot connectors, box-to-tray plates and closure end plate

Branch pivot connectors

	Cat. no.	Material	Side rail height (in.)
	ABW-4-BPC	Aluminum	4
	ABW-5-BPC	Aluminum	5
	ABW-6-BPC	Aluminum	6
	ABW-7-BPC	Aluminum	7

Allows cables to run from one tray level to another.



- Designed to secure tray to electrical panels or boxes, walls or end supports
- Furnished in pairs with hardware
- Kit contents: 8 bolts, 8 nuts, 8 lock washers, $\frac{3}{8}$ in. diameter

Box-to-tray plates

	Cat. no.	Material	Side rail height (in.)
	ABW-4-BSP	Aluminum	4
	ABW-5-BSP	Aluminum	5
	ABW-6-BSP	Aluminum	6
	ABW-7-BSP	Aluminum	7



- Provides closure for any tray end
- Packaged with hardware
- Kit contents: 4 bolts, 4 nuts, 4 washers, $\frac{3}{8}$ in. diameter
- Side rail heights: 4 in., 5 in., 6 in., 7 in.
- Inside tray widths: 06, 09, 12, 18, 24, 30, 36, 42 in.

Closure end plate

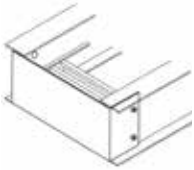
	Cat. no.	Material	Side rail height (in.)*	Tray width (in.)**
	ABW-(*)(**)-CEP	Aluminum	4 to 7	06 to 42

(*) Insert side rail height

(**) Insert tray width

Aluminum splice plates

Reducing splice plate, step-down splice plate, Super-Duty Splice Plate™

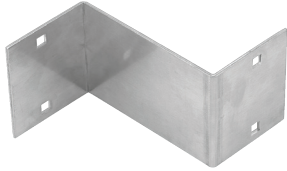

- Used in pairs to provide a straight reduction or used with a standard splice plate for an offset reduction
- Packaged with hardware
- Kit contents: 4 bolts, 4 nuts

Reducing splice plate

	Cat. no.	Material	Side rail height (in.)
	ABW-4(*)-RSP	Aluminum	4
	ABW-5(*)-RSP	Aluminum	5
	ABW-6(*)-RSP	Aluminum	6
	ABW-7(*)-RSP	Aluminum	7

(*) For offset reduction: insert width to be reduced. For straight reduction: insert ½ width to be reduced (2 required).
 Example: ABW-43-RSP = 3 in. offset reducer.

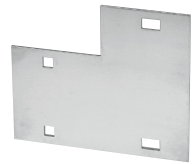

- Connects side rails of different heights
- Kit contents: 4 bolts, 4 nuts

Step-down splice plate

	Cat. no.	Material	Side rail height (in.)
	ABW(*)(**)SDS	Aluminum	4
		Aluminum	5
		Aluminum	6
		Aluminum	7

(*) Side rail height 1. (**) Side rail height 2.
 Side rail height 1 is greater than side rail height 2.

- 2 Super-Duty Splice Plates
- 12 ribbed-neck carriage bolts
- 8 nylon insert locknuts
- 8 serrated flanged locknuts
- 12 nylon washers (spacers)

Super-Duty Splice Plate

	Cat. no.	Side rail height (in.)
	ABW(*)SDP	4
		5
		6
		7

Comes complete with all hardware required, for either expansion or mid-span splicing.

Splice plates

Over-support splice adaptor

—
01 Expansion plate
gap chart

—
Every expansion joint
requires the use
of a bonding jumper
such as FBD16-1
(16 in., 600 amps)



—
ABW46-OSS-B

Over-support splice adaptor – Beam installation

- Expansion over support beam 29 in.
- SHW-CTC, heavy-duty hold-down clamp (complete with mounting hardware)
- ABWCHGC, standard hold-down clamp
- E142-3/8x100EG, 3/8 in.-16 x 1 in. hex cap screws
- AC100-3/8EGC, 3/8 in. strut nut

—
01

—
ABW46-OSS-S

Over-support splice adaptor – Strut installation

- Expansion over support beam 29 in.
- ABWCHGC, standard hold-down clamp
- E142-3/8x100EG, 3/8 in.-16 x 1 in. hex cap screws
- AC100-3/8EGC, 3/8 in. strut nut

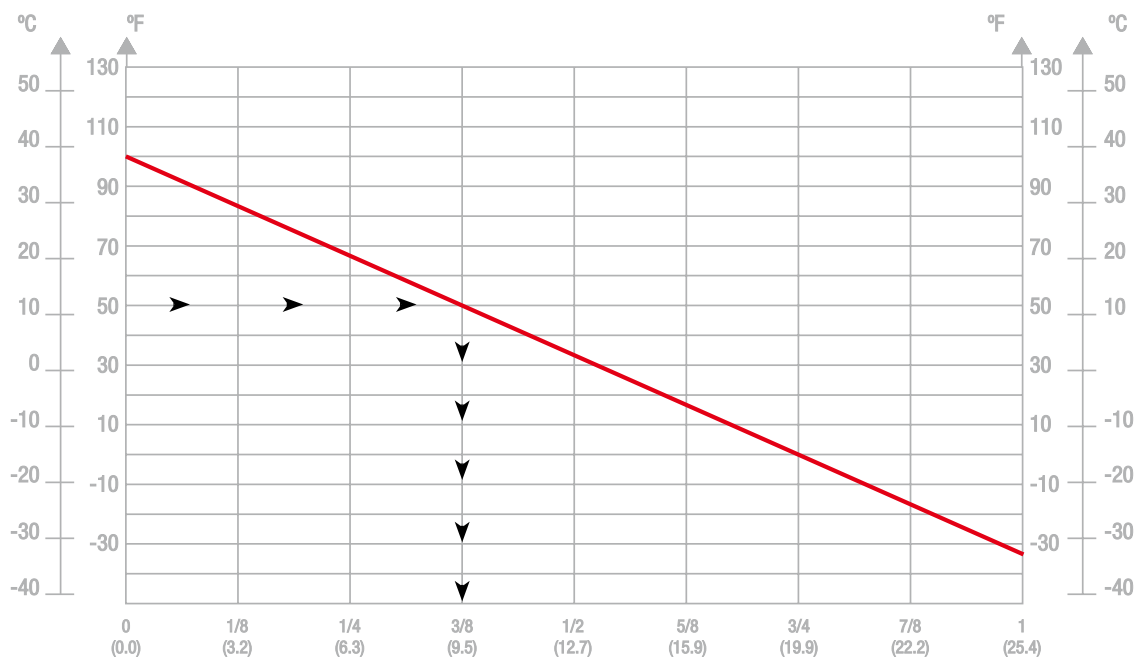



Aluminum cable protection

Drop out and wall penetration sleeve



- Designed to provide a smooth radius surface at any position on the tray or trough bottom
- Drop outs are easily attached using hardware provided
- Standard radius 4 in.
- Tray widths: 06, 09, 12, 18, 24, 30, 36, 42 in.

Drop out

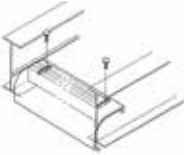
	Cat. no.	Description	Tray width (in.)
	ABW(*)DO(S)	For ladder and ventilated tray, aluminum	06 to 42

(*) Insert tray width
(S) Solid tray only



- Designed to pass through walls and fire walls.
- Hardware included
- Important: Not fire rated
- Fire stop not included
- Sold with cover
- Side rail heights: 4, 5, 6, 7 in.
- Tray widths: 06, 09, 12, 18, 24, 30, 36, 42 in.

Wall penetration sleeve

Cat. no.	Material	Side rail height (in.)	Tray width (in.)
ABW(*)(**)WPS	Aluminum	4 to 7	06 to 42

(*) Insert side rail height.
(**) Insert tray width

Aluminum cable protection

Frame-type tray-to-box plate and expansion pad

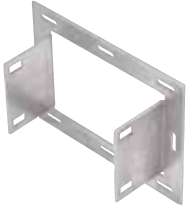

- Designed to secure tray to electrical enclosures and panels
- Hardware included
- Side rail heights: 4, 5, 6, 7 in.
- Tray widths: 06, 09, 12, 18, 24, 30, 36, 42 in.

Frame-type tray-to-box plate

Cat. no.	Material	Side rail height (in.)	Tray width (in.)
ABW(*)(**)FBP	Aluminum	4 to 7	06 to 42

(*) Insert side rail height. (**) Insert tray width

Nylon expansion pad

Cat. no.	Material
ABW-NSP	Natural nylon



Allows for thermal expansion and contraction of cable trays over supports.

Aluminum barrier strips

Barrier strips, vertical bend barriers

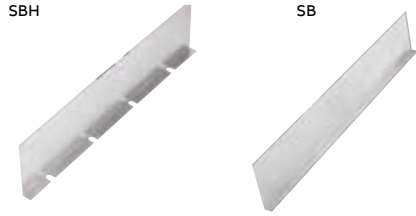

- Aluminum barrier strips provide a method of separating cables in tray and trough systems
- Easily installed using supplied hardware
- 72 in. barriers are flexible for use with horizontal fittings

Barrier strips

Cat. no.	Designed for side rail height (in.)	Length
ABW-4-SBH-72	4	72 in.
ABW-5-SBH-72	5	72 in.
ABW-6-SBH-72	6	72 in.
ABW-7-SBH-72	7	72 in.
ABW-4-SB-(*)	4	144 in. 3 m
ABW-5-SB-(*)	5	144 in. 3 m
ABW-6-SB-(*)	6	144 in. 3 m
ABW-7-SB-(*)	7	144 in. 3 m

72 in. barriers provided with 3 SPW10SCR. 144 in., 3 m barriers provided with 6 SPW10SCR.

(*) Insert length.

Inside/outside vertical bend barriers

	Inside bend cat. no.	Outside bend cat. no.	Designed for side rail height (in.)
	AUW(*)VIB-(* *)-(+)	AUW(*)VOB-(* *)-(+)	4
	AUW(*)VIB-(* *)-(+)	AUW(*)VOB-(* *)-(+)	5
	AUW(*)VIB-(* *)-(+)	AUW(*)VOB-(* *)-(+)	6
	AUW(*)VIB-(* *)-(+)	AUW(*)VOB-(* *)-(+)	7
	AHW(*)VIB-(* *)-(+)	AHW(*)VOB-(* *)-(+)	4
	AHW(*)VIB-(* *)-(+)	AHW(*)VOB-(* *)-(+)	5
	AHW(*)VIB-(* *)-(+)	AHW(*)VOB-(* *)-(+)	6
	AHW(*)VIB-(* *)-(+)	AHW(*)VOB-(* *)-(+)	7

(*) Insert side rail height (* *) Insert bend angle (+) Insert bend radius.

Barrier strip splice

	Cat. no.	Material
	ABWBSS	Plastic

Alignment splice for joining connecting barrier strips.

Aluminum clamps and hardware

Hold-down clamps, combo clamps, conduit clamps and tray hardware

Hold-down clamp

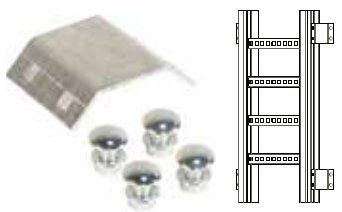
	Cat. no.	Type	Material	Design load
	ABW-HDCS	Single	Aluminum	600 lb/pair
	ABW-HDCD	Double	Aluminum	1000 lb/pair

For vertical applications

Cable tray combo clamp

	Cat. no.	Material	Hardware size (in.)
	ABWCHGC	Aluminum	$\frac{3}{8}$
	ABWCHGC-HDW*	Aluminum	$\frac{3}{8}$

*Hardware supplied: 1 bolt and 1 springless strut nut $\frac{3}{8}$ in. diameter.

Conduit clamp

	Cat. no.	Material	Conduit size (in.)
	ABW-100-CDO	Aluminum	1
	ABW-125-CDO	Aluminum	1 $\frac{1}{4}$
	ABW-150-CDO	Aluminum	1 $\frac{1}{2}$
	ABW-200-CDO	Aluminum	2
	ABW-250-CDO	Aluminum	2 $\frac{1}{2}$
	ABW-300-CDO	Aluminum	3
	ABW-400-CDO	Aluminum	4

Aluminum tray hardware

	Cat. no.	Material	Description
	SPW-1/4-CB	Zinc-plated steel	$\frac{1}{4}$ in. carriage bolt
	SPW-3/8-CB	Zinc-plated steel	$\frac{3}{8}$ in. carriage bolt
	SPW-1/4-HN	Zinc-plated steel	$\frac{1}{4}$ in. hex. nut
	SPW-3/8-HN	Zinc-plated steel	$\frac{3}{8}$ in. hex. nut
	SPW3/8HWK*	Zinc-plated steel	Zinc-plated steel hardware kit
	SPW-3/8HXHWK**	Zinc-plated steel	Hardware kit $\frac{3}{8}$ in. for large radius crosses
	SSW-3/8-CB	316 stainless	$\frac{3}{8}$ in. carriage bolt
	SSW-3/8-HN	316 stainless	$\frac{3}{8}$ in. hex. nut
	SSW38HWK*	316 stainless	316 stainless steel hardware kit
	SSW-3/8HXHWK**	316 stainless	Hardware kit $\frac{3}{8}$ in. for large radius crosses

*Contains 8 bolts and 8 nuts.

**Contains 6 bolts, 6 nuts and 6 washers.

Aluminum clamps and hardware

Self-drilling tapping screws, cable tray guide, cable tray clamp and vertical tray hanger

Self-drilling tapping screw

	Cat. no.	Material	Description
	SPW-10-SCR	Zinc-plated steel	Self-drilling tapping screw
		Stainless steel	Self-drilling tapping screw



- Expansion guide for single or double runs of cable tray
- No need to field drill the channel or I-beam

Cable tray guide

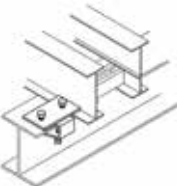
	Cat. no.	Material
	SPW-CTG	Zinc-plated steel
		Hot-dipped galvanized steel



- Clamp for single run of cable tray
- No need to field drill the channel or I-beam

Cable tray clamp

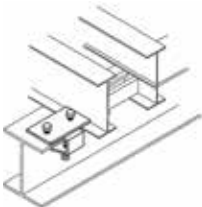
	Cat. no.	Material
	SPW-CTC	Zinc-plated steel
		Hot-dipped galvanized steel

Vertical tray hanger

	Cat. no.	Material	Side rail height (in.)
	ABW(*)VTH	Aluminum	4
		Aluminum	5
		Aluminum	6
		Aluminum	7

(*) Insert side rail height