

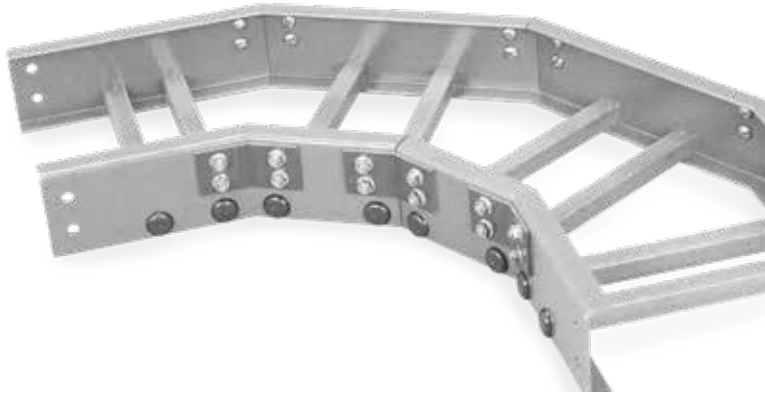

B

T&B[®] Cable Tray

Nonmetallic cable tray systems



—

B

T&B Cable Tray

Nonmetallic cable tray systems

Table of contents

Section B

Overview	B5
Technical information	B7
FRP cable tray specifications	B13
Nonmetallic cable tray - Straight lengths	B14
Nonmetallic cable tray - Fittings	B23
Nonmetallic cable tray - Splice plates	B38
Nonmetallic cable tray systems	B42
Nonmetallic cable tray - Covers	B44
Nonmetallic cable tray - Accessories	B45
Nonmetallic channel tray - Straight lengths	B46
Nonmetallic channel tray - Fittings	B48
Nonmetallic channel tray systems	B50
Nonmetallic strut systems	B52



Nonmetallic - Cable tray

Overview

Why specify our cable tray?

Nonmetallic cable tray systems have been tested and proven in the harsh environment of the offshore oil and gas industry. This tray is ideally suited to withstand the corrosive conditions inherent in the petroleum, mining, and fertilizer industries. In these applications, nonmetallic tray is exposed daily to wind, weather, and saltwater.

Nonmetallic cable tray gives you the load capacity of steel plus the inherent characteristics afforded by our pultrusion technology: non-conductive, non-magnetic and corrosion-resistant. Although light in weight, their strength-to-weight ratio surpasses that of equivalent steel products.

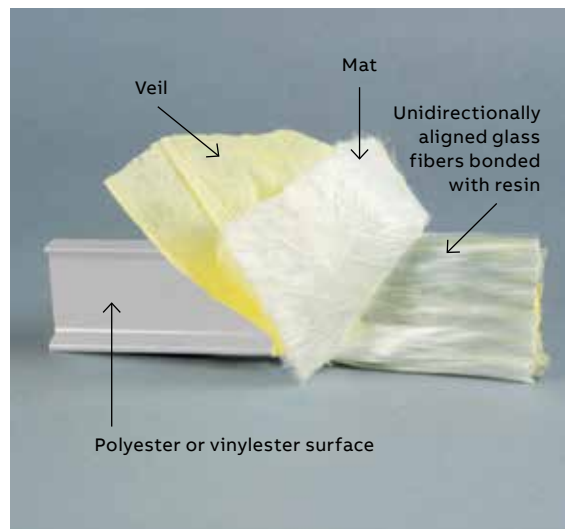

—
01

—
01 A surface veil is applied during the pultrusion process to ensure a resin rich surface for superior corrosion resistance as well as an ultraviolet exposure barrier.



Nonmetallic - Cable tray

Overview (continued)



Why specify our cable tray?

Nonmetallic cable tray systems have been tested and proven in the harsh environment of the offshore oil and gas industry. This tray is ideally suited to withstand the corrosive conditions inherent in the petroleum, mining, and fertilizer industries. In these applications, nonmetallic tray is exposed daily to wind, weather, and saltwater.

Nonmetallic cable tray gives you the load capacity of steel plus the inherent characteristics afforded by our pultrusion technology: non-conductive, non-magnetic and corrosion-resistant. Although light in weight, their strength-to-weight ratio surpasses that of equivalent steel products.

Table 1 – Typical properties of pultruded components gland

Properties	Test method	Unit/value	Isophthalic Polyester	
			Longitudinal	Transverse
Tensile strength	ASTM D638	psi	30,000	7,000
Tensile modulus	ASTM D638	psi x 10 ⁶	2.5	0.8
Flexural strength	ASTM D790	psi	30,000	10,000
Flexural modulus	ASTM D790	psi x 10 ⁶	1.6	0.8
Izod impact	ASTM D256	ft.-lbs/in	25	4
Compressive strength	ASTM D695	psi	30,000	15,000
Compressive modulus	ASTM D695	psi x 10 ⁶	2.5	1.0
Barcol hardness	ASTM D2583	–	50	45
Shear strength	ASTM D732	psi	5,500	5,500
Density	ASTM D1505	lbs/in ³	0.065	–
Coefficient of thermal expansion	ASTM D696	in/in/°F	5.0 x 10 ⁻⁶	–
Water absorption	ASTM D570	Max %	0.5	–
Dielectric strength	ASTM D149	V/mil (vpm)	200	–
Flammability classification	UL94	VO (both resins)	–	–
Flame spread	ASTM E-84	20 Max (both resins)	–	–

T&B nonmetallic cable tray systems are manufactured from glass fiber-reinforced plastic shapes that meet the ASTM E-84 Class 1 flame rating and self-extinguishing requirements of ASTM D-635. A surface veil is applied during pultrusion to ensure a resin-rich surface and ultraviolet resistance.

Table 1 – Typical properties of pultruded components gland

Properties	Ignition	Burning	Rating	Avg. Extent of Burning
Flame resistance (FTMS 406-2023)	75 seconds	75 seconds	–	–
Intermittent flame test (HLT- 15)	–	–	100	–
Flammability test (ASTM D635)	–	5 seconds	–	15mm

Technical information

Corrosion guide

The information shown in this corrosion guide is based on full immersion laboratory tests and data generated from resin manufacturers. It should be noted that in some of the environments listed, splashes and spills may result in a more corrosive situation than indicated due to the evaporation of water. Regular wash down is recommended in these situations.

Chemical resistance

Chemical environment	75°F (24°C)	160°F° (71°C)
Acetic Acid 5%	FR-P	FR-P
Acetic Acid 25%	FR-P	FR-VE-210° (*)
Aluminum Potassium Sulfate 5%	FR-P	FR-P
Ammonium Hydroxide 10%	FR-P	FR-VE-150°
Ammonium Nitrate	FR-P	FR-P
Benzenesulfonic Acid 5%	FR-P	FR-P
Calcium Chloride	FR-P	FR-P
Carbon Tetrachloride	FR-VE	FR-VE-100° (*)
Chlorine Dioxide 15%	FR-P	FR-VE-150° (*)
Chromic Acid 5%	FR-P	FR-VE-150° (*call)
Copper Sulfate	FR-P	FR-P
Diesel Fuel No. 1	FR-P	FR-P
Diesel Fuel No. 2	FR-P	FR-P
Ethylene Glycol	FR-P	FR-P
Fatty Acids 100%	FR-P	FR-P
Ferrous Sulfate	FR-P	FR-P
Fluosilicic Acid 0-20%	FR-VE	FR-VE (call)
Hydrochloric Acid 1%	FR-P	FR-P
Hydrochloric Acid 15%	FR-P	FR-VE-180° (*)
Hydrochloric Acid 37%	FR-P	FR-VE-150° (*)
Hydrogen Sulfide	FR-P-140°	FR-VE-210°
Kerosene	FR-P	FR-P
Magnesium Chloride	FR-P	FR-P

Chemical environment	75°F (24°C)	160°F° (71°C)
Methyl Alcohol 10%	FR-P	FR-VE-150° (*)
Naphtha	FR-P	FR-P
Nitric Acid 5%	FR-P	FR-P
Nitric Acid 20%	FR-VE	FR-VE-120° (*)
Phosphoric Acid 10%	FR-P	FR-P
Phosphoric Acid 30%	FR-P	FR-P
Phosphoric Acid 85%	FR-P	FR-P
Sodium Bicarbonate 10%	FR-P	FR-P
Sodium Bisulfate	FR-P	FR-P
Sodium Carbonate	FR-P	FR-VE
Sodium Chloride	FR-P	FR-P
Sodium Hydroxide 1-50%	FR-VE	FR-VE-120° (*)
Sodium Hypochlorite 5%	FR-P	FR-VE-120° (*)
Sodium Nitrate	FR-P	FR-P
Sodium Silicate	FR-P	FR-VE-210° (*)
Sodium Sulfate	FR-P	FR-P
Sulfuric Acid 0-30%	FR-P	FR-P
Sulfuric Acid 30-50%	FR-VE	FR-VE
Sulfuric Acid 50-70%	FR-VE	FR-VE-180° (*)
Trisodium Phosphate 25%	FR-P	FR-VE-210° (*)
Trisodium Phosphate - All	FR-VE	FR-VE-210° (*)
Water, Distilled	FR-P	FR-P

Symbols:
FRP - Polyester fire-retardant
FRVE - Vinyl Ester fire-retardant

All data represents the best available information and is believed to be correct. The data should not be construed as a warranty of performance for that product as presented in these tables. User tests should be performed to determine suitability of service if there is any doubt or concern. Such variables as concentration, temperature, time of exposure and combined chemical effects of mixtures of chemicals make it impossible to specify the exact suitability of fiber-reinforced plastics in all environments. ABB will be happy to supply material samples for testing. These recommendations should only be used as a guide, and ABB does not take responsibility for design or suitability of materials for service intended. In no event will ABB be liable for any consequential or special damages for any defective material or workmanship including, without limitation, labor charges or other expenses or damage to property resulting from loss of materials or profits or increased expenses of operations.

Technical information

CSA and NEMA loading classes

The standard classes of cable trays, as related to their maximum design loads and to the associated design support spacing based on a simple beam span requirement, shall be designated in accordance with Table 1.

Selection process

Please note the load ratings in Table 1 are those most commonly used. Other load ratings are acceptable. (according to NEMA VE-1/CSA C22.2 No 126.1-02).

Costs vary between different load classes. Since labor and coupling costs are similar for a given length of tray, the heavier classes are less cost-effective on a load length basis. The designer should therefore specify the lightest class of tray compatible with the weight requirements of the cable tray.

Table 1 – Span/load class designation – USA

Load		Span m (ft.)				
kg/m	(lb/ft.)	1.5 (5)	2.4 (8)	3.0 (10)	3.7 (12)	6.0 (20)
37	(25)	5AA	8AA	10AA	12AA	20AA
74	(50)	5A	8A	10A	12A	20A
112	(75)	–	8B	–	12B	20B
149	(100)	–	8C	–	12C	20C

NOTE: These ratings are also used in Mexico.

Table 1 – Span/load class designation – CANADA

Load		Span m (ft.)							
kg/m	(lb/ft)	1.5 (5)	2.0 (6.5)	2.5 (8.2)	3.0 (10)	4.0 (13)	5.0 (16.4)	6.0 (20)	
37	(25)	–	–	–	A	–	–	–	
45	(30)	–	–	A	–	–	–	–	
62	(42)	–	A	–	–	–	–	–	
67	(45)	–	–	–	–	–	–	D	
82	(55)	–	–	–	–	–	–	D	
97	(65)	–	–	–	C	–	–	–	
99	(67)	A	–	–	–	–	–	–	
112	(75)	–	–	–	–	–	–	E	
113	(76)	–	–	–	–	D	–	–	
119	(80)	–	–	C	–	–	–	–	
137	(92)	–	–	–	–	–	E	–	
164	(110)	–	C	–	–	–	–	–	
179	(120)	–	–	–	D	–	–	–	
189	(127)	–	–	–	–	E	–	–	
259	(174)	C	–	–	–	–	–	–	
299	(200)	–	–	–	E	–	–	–	

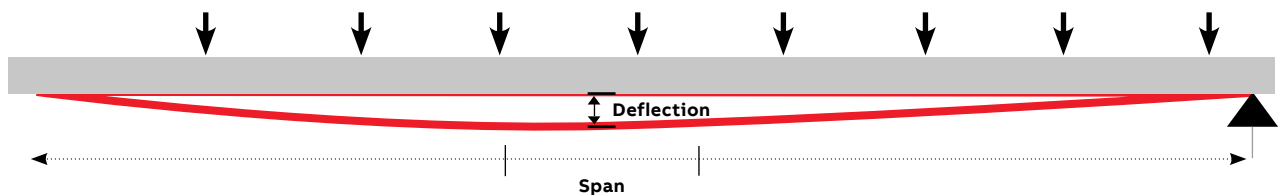

—

Loading capacity

Cable loads

The cable load is the total weight, expressed in (lb/ft.), of all the cables that will be placed in the cable tray.

Snow loads

Depending on the area, snowfall could indicate an additional design load. If snowfall is a factor and the tray has a solid cover in outdoor installations, a minimum load of 5 lb (2.27kg). per square foot should be used.

Ice loads

If a cable tray system is subject to icing conditions, usually only the top surface or cover and the windward side will be coated with any significant amount. It is generally assumed that ice weighs 57 lb (25.85kg) per cubic foot.

Wind loads

All outdoor cable tray installations should factor in wind loads, especially the pressure exerted on side rails of ladder trays. There have also been instances of strong winds lifting covers off trays, which can be minimized with the use of wraparound cover clamps.

—

Concentrated loads

A concentrated static load is not included in Table 1 (following page). Some user applications may require that a given concentrated static load be imposed over and above the working load.

Such a concentrated static load represents a static weight applied on the centerline of the tray at midspan. When so specified, the concentrated static load may be converted to an equivalent uniform load (We) in kilograms/meter (pounds), using the following formula, and added to the static weight of cable in the tray:

$$We = \frac{2 \times (\text{concentrated static load, kg (lb)})}{\text{Span length, m (ft.)}}$$

This combined load may be used to select a suitable load/span designation. If the combined load exceeds the working load shown on the following page, the manufacturer should be consulted.

—

Effect of temperature

Strength properties of reinforced plastics are reduced when continuously exposed to elevated temperatures. Working loads shall be reduced based on table 2.

—

Table 2 – Effect of temperature

Temperature		Approximate % of strength	
(°C)	(°F)	Isophthalic polyester	Vinylester
23.8	75	100	100
37.7	100	90	100
51.6	125	78	100
65.5	150	68	90
79.4	175	60	90
93.3	200	52	75

NEMA Standard 8-10-1986.

If unusual temperature conditions exist, the manufacturer should be consulted.

Technical information

Thermal contraction and expansion

It is important that thermal contraction and expansion be considered when installing cable tray systems. The length of the straight cable tray runs and the temperature differential govern the number of expansion splice plates required (see Table 1 below).

01 Typical cable tray installation

The cable tray should be anchored at the support nearest to its midpoint between the expansion splice plates and secured by expansion guides at all other support locations (see diagram 01). The cable tray should be permitted longitudinal movement in both directions from that fixed point.

Accurate gap setting at the time of installation is necessary for the proper operation of the expansion splice plates. The following procedure should assist the installer in determining the correct gap (see Figure 1):

1. Plot the highest expected tray temperature on the maximum temperature line.
2. Plot the lowest expected tray temperature on the minimum temperature line.
3. Draw a line between the maximum and minimum points.
4. Plot the tray temperature at the time of installation to determine the gap setting.

Figure 1 - Proper gap settings

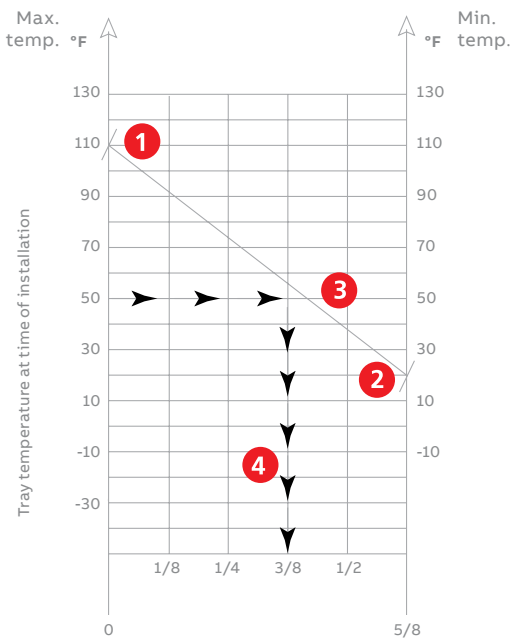
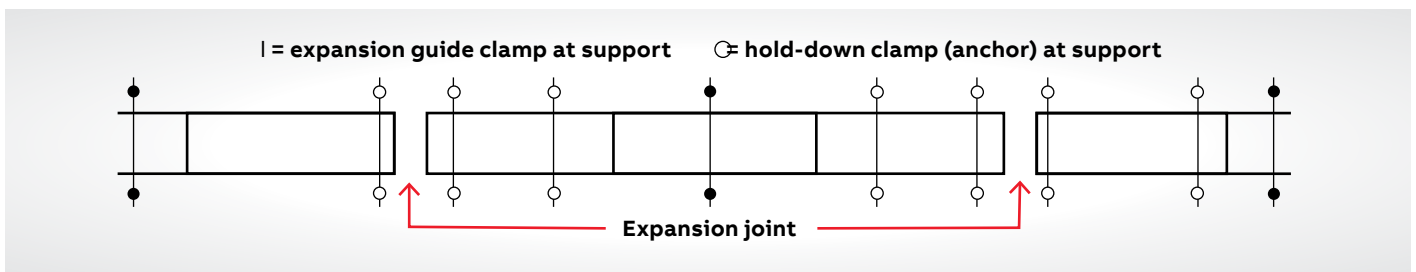

Table 1 - Expansion or contraction for various temperature differences

Temperature differential		Max. distance between expansion connector* for 1" (25.4mm) expansion		Max. distance between expansion connector* for 5/8" (15.9mm) expansion	
°F	°C	(ft.)	(m)	(ft.)	(m)
14	25	667	203.3	417	127.1
28	50	333	101.5	208	63.3
42	75	222	67.6	139	42.3
56	100	167	50.9	104	31.7
70	125	133	40.5	83	25.2
83	150	111	33.8	69	21
97	175	95	28.9	59	17.9

NOTE: These ratings are also used in Mexico.

01



Technical information

Installation guidelines

Installation of T&B nonmetallic cable tray should be made in accordance with the standards set by the NEMA VE2 publication and CSA standards.

Always observe common safety practices when assembling tray and fittings. Installations generally require some field cutting. Dust created during fabrication presents no serious health hazard, but skin irritation may be experienced by some workers.

Operators of saws and drills should wear masks, long-sleeve shirts or coveralls.

Fabrication with nonmetallic cable tray is relatively easy and comparable to working with wood. Ordinary hand tools may be used in most cases.

Avoid excessive pressure when sawing or drilling. Too much force can rapidly dull tools and also produce excessive heat, which softens the bonding resin in the nonmetallic cable tray, resulting in a ragged edge rather than a clean-cut edge.

Field cutting is simple and can be accomplished with a circular power saw with an abrasive cut-off wheel (masonry type) or hack saw (24 to 32 teeth per inch).

Drill nonmetallic as you would drill hardwood. Standard twist drills are more than adequate. Any surface that has been drilled, cut, sanded or otherwise broken must be sealed with a compatible resin. Carbide-tipped saw blades and drill bits are recommended when cutting large quantities.

Support the nonmetallic cable tray material firmly during cutting operations to keep material from shifting, which may cause chipping at the cut edge.

Each tray section length should be equal to or greater than the support span. When possible, the splice should be located at quarter span.

Fittings should be supported as per NEMA VE2.

Technical information

Cable tray support locations

Horizontal elbow

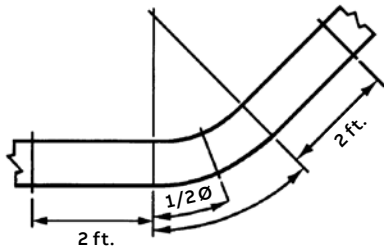

Vertical elbow

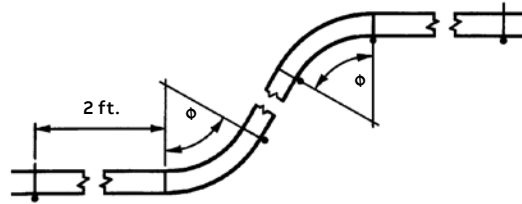

Horizontal tee

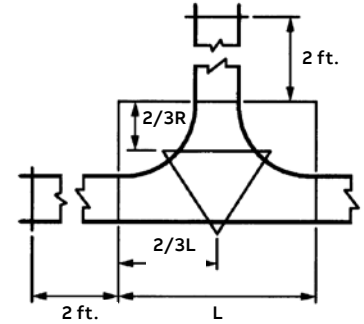

Horizontal wye

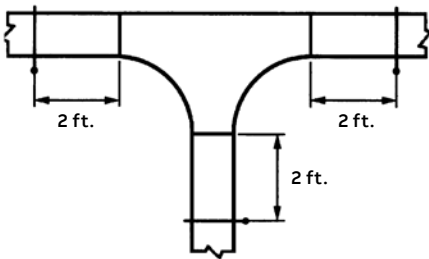

Horizontal cross

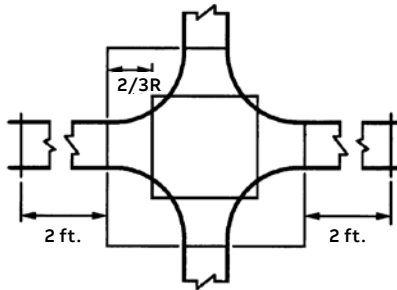

Horizontal reducer

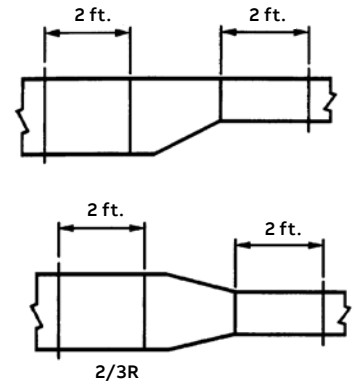

*NOTE: $\phi = 30^\circ, 45^\circ, 60^\circ, 90^\circ$ (degree of fitting)

FRP Cable Tray specifications

External revision 1

*Dimension
Conversion Table:

2"	= 50.8mm
3"	= 76.2mm
4"	= 101.6mm
5"	= 127mm
7"	= 177.8mm
6"	= 152.4mm
8"	= 203.2mm
9"	= 228.6mm
9.25"	= 235mm
12"	= 304.8mm
18"	= 355.6mm
18.5"	= 470mm
24"	= 457.2mm
30"	= 762mm
36"	= 914.4mm
42"	= 1,066.8mm

Section 1 - Acceptable manufacturers

- 1.01** Cable tray system will be made of straight sections, fittings and accessories as defined in the latest CSA/NEMA standards publication.
- 1.02** All manufacturing practices will be in accordance with CSA/NEMA.
- 1.03** Cable trays will be by ABB, or approved CSA/NEMA member.

Section 2 - Cable tray design

- 2.01** Straight section structural elements; side rails, rungs and splice plates shall be pultruded from glass fiber reinforced polyester or vinylester resin.
- 2.02** Pultruded shapes will be constructed with a surface veil to ensure a resin-rich and ultravioletresistant surface.
- 2.03** Pultruded shapes shall meet the ASTM E-84 Class 1 flame rating and self-extinguishing requirements of ASTM D-635.

Section 3 - Construction

- 3.01** Straight section lengths will be 120" (10 ft. (3.05m)) or 240" (20 ft. (6.10m)) standard.
- 3.02** Side rails will be inward "C" configuration and be predrilled to accept splice plates.
- 3.03** Overall heights shall be 8, 6, 4 or 3" (*mm) respectively.
- 3.04** Loading depths for cable tray systems shall be 7, 5, 3 or 2" (*mm) as per CSA/NEMA tolerances.

- 3.05** Loading classifications and test specimens shall be per CSA/NEMA.

- 3.06** Rung spacing shall be 6, 9.25, 12 or 18.5" (*mm)

Section 4 - Dimensions

- 4.01** All fittings shall be of mitered design type with a minimum 3" (76.2mm) tangent following the radius.
- 4.02** All fittings shall have a nominal 9.25" rung spacing.
- 4.03** Width (usable inside tray width) shall be 6, 9, 12, 18, 24, 30 or 36" (*mm).
- 4.04** Outside width shall not exceed inside width by more than a total of 2" (50.8mm).
- 4.05** Straight and expansion splice plates will be of stainless steel or fiberglass design with an eight-bolt pattern in 5" (127mm) fill systems and four-bolt pattern for 3, 4, 6 and 8" tray depths.
- 4.06** Dimension tolerances will be per CSA/NEMA.
- 4.07** Cable tray must have integral connection between side rails and rungs consisting of nonmetallic mechanical fasteners and adhesive bonding.

Nonmetallic - Cable tray

Straight lengths

Applications

Nonmetallic cable tray systems

Nonmetallic cable tray systems have been tested and proven in the harsh environment of the offshore oil and gas industry – subject to the corrosive conditions inherent in petroleum products, plus the daily punishment of exposure to wind, weather and saltwater.

Nonmetallic cable tray systems have stood up to these challenges.



Selection guide

1. Nonmetallic cable tray system.
2. Select the correct T&B series cable tray using the load data for straight sections found on page B16-B20.
3. Select the resin required. Refer to corrosion guide on page B7 of the technical information section for the effect of environmental conditions on the desired material. For the effective temperature range, see page B9 of the same section.
4. Select the rung spacing required to properly support cables in tray.
5. Select the desired width in inches.
6. Select the straight section length in inches.

Straight fittings number selection

To order

To order a straight section of cable tray, select the appropriate size and material from the charts below and place those symbols in the sequence shown to form the complete catalog number.

Example:

- NM-4P0924-120 for
- 4" (101.6mm) side rail, polyester resin
- 9" (228.6mm) rung spacing
- 24" (609.6mm) wide, 120" (10 ft. (36.58m)) length

NOTE: One pair of nonmetallic splice plates with SS6 hardware included with each length. For other types of splice plates, see pages B38-B41.

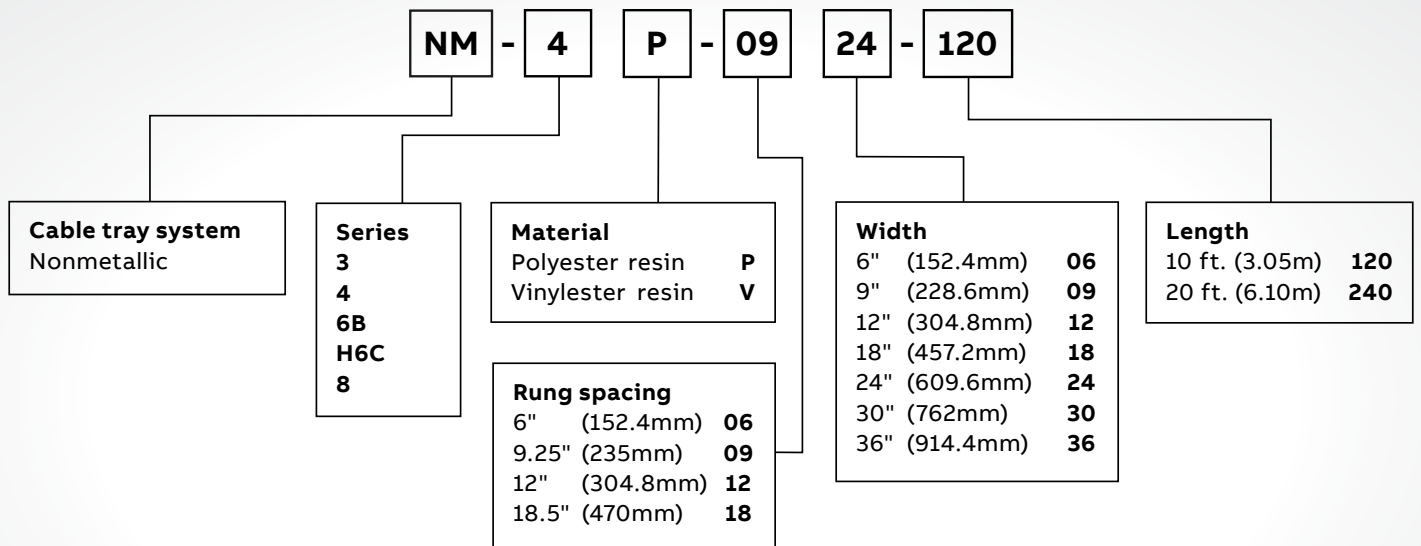

Series 3 cable tray does not have UL listing.

Nonmetallic - Cable tray straight lengths

3" (76.2mm) Straight sections - Series 3



Splice plates

One pair of nonmetallic splice plates with SS6 (316 stainless steel) hardware included.

Deflection factor: To calculate deflection at any span length for lighter loads than listed, multiply the load by the K factor. When trays are used in continuous spans, the deflection of the tray is reduced by as much as 50%.

Loading

- CSA load class: A/3M
- NEMA 8A

3" (76.2mm) Straight sections – Series 3: Loading - NEMA 8A

		Support span ft. (m)
	Series	8' (2.4m)
	3	
Side rail height: 3" (76.2mm) (1 ³ / ₁₆ " (46.04mm) loading depth)		Safety Factor
	Load (lb)/ft.)	1.5
	Load (kg)/m)	1.5
	Deflection (in.)	1.5
	Deflection (mm)	1.5
	K factor	1.5
		50
		74
		2.35
		59.69
		0.0162

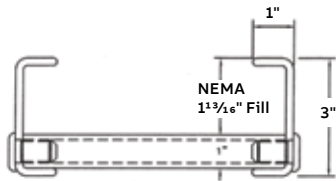

Straight section number selection

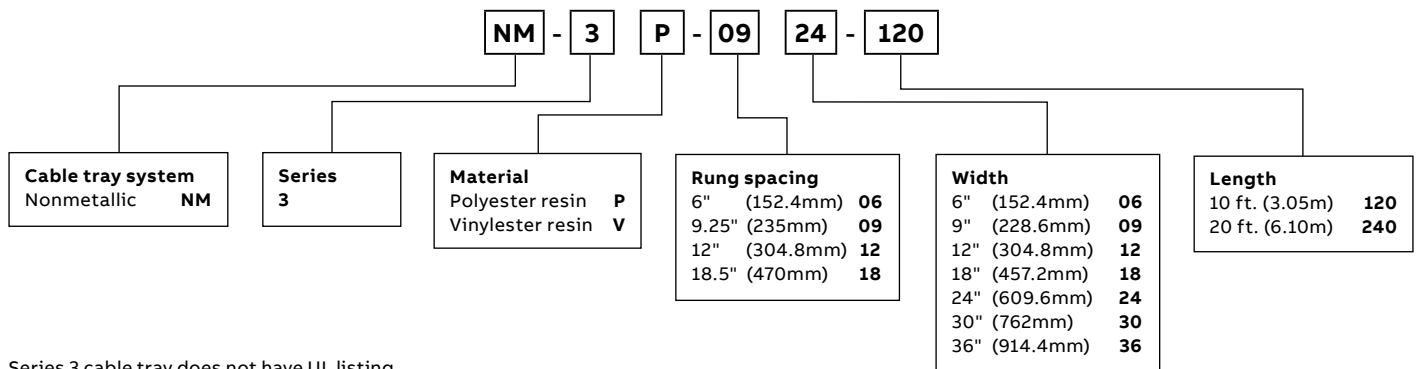

Series 3 cable tray does not have UL listing.

Nonmetallic - Cable tray straight lengths

4" (101.6mm) Straight sections - Series 4



Splice plates

One pair of nonmetallic splice plates with SS6 (316 stainless steel) hardware included.

Deflection factor: To calculate deflection at any span length for lighter loads than listed, multiply the load by the K factor. When trays are used in continuous spans, the deflection of the tray is reduced by as much as 50%.

Loading

- CSA load class: D/3M
- NEMA 12C
- UL Listing load class C

4" (101.6mm) Straight sections – Series 4: Loading - NEMA 12C

Series	Support span ft (m)				
	Safety Factor	8' (2.4m)	10' (3m)	12' (3.7m)	
Side rail height: 4" (101.6mm) (2¾" (69.85mm) loading depth)	Load (lb)/ft.)	1.5	205	144	100
	Load (kg)/m)	1.5	303	214	148
	Deflection (in.)	1.5	1.18	2.03	2.92
	Deflection (mm)	1.5	29.972	51.562	74.168
	K factor	1.5	0.005	0.014	0.029

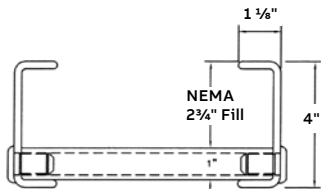

Straight section number selection

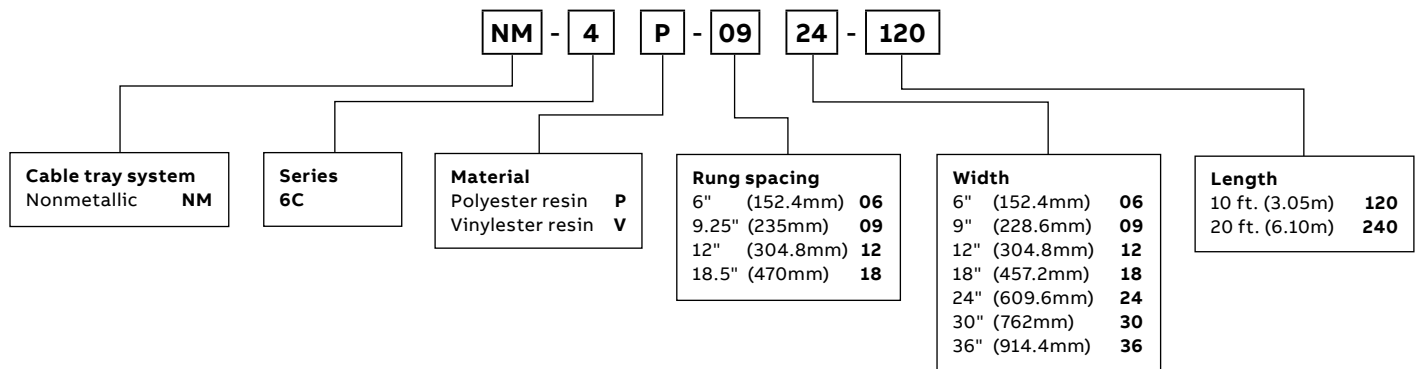

Nonmetallic - Cable tray straight lengths

6" (152.4mm) Straight sections - Series 6



Splice plates

One pair of nonmetallic splice plates with stainless hardware included.

Deflection factor: To calculate deflection at any span length for lighter loads than listed, multiply the load by the K factor. When trays are used in continuous spans, the deflection of the tray is reduced by as much as 50%.

Loading

- CSA load class: E/6M
- NEMA 20C
- UL Listing load class C

6" (152.4mm) Straight sections - Series 6B: Loading - NEMA 20C

Series	Safety Factor	Support span ft. (m)				
		14' (4.3m)	16' (4.9m)	18' (5.5m)	20' (6.1m)	
6B	Load (lb)/ft.)	1.5	204	156	123	100
	Load (kg)/m)	1.5	304	233	184	149
	Deflection (in.)	1.5	2.59	3.4	4.3	5.28
	Deflection (mm)	1.5	86.36	86.36	109.22	134.112
	K factor	1.5	0.0139	0.0237	0.038	0.058

Side rail height: 6" (152.4mm)
 (4¾" (120.65mm) loading depth)

Straight section number selection

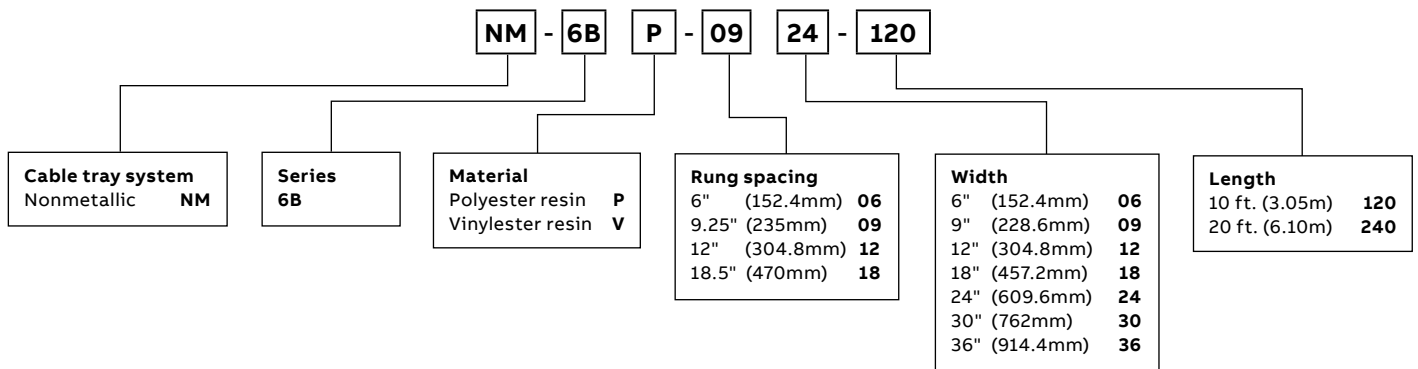

Nonmetallic - Cable tray straight lengths

6" (152.4mm) Straight sections - Series H6C



Splice plates

One pair of nonmetallic splice plates with SS6 (316 stainless steel) hardware included.

Deflection factor: To calculate deflection at any span length for lighter loads than listed, multiply the load by the K factor. When trays are used in continuous spans, the deflection of the tray is reduced by as much as 50%.

Loading

- CSA load class: E/6M
- NEMA 20C
- UL Listing load class C

6" (152.4mm) Straight sections - Series H6C: Loading - NEMA 20C

Series	Safety Factor	Support span ft. (m)				
		14' (4.3m)	16' (4.9m)	18' (5.5m)	20' (6.1m)	
Side rail height: 6" (152.4mm) (4 1/16" (119.1mm) loading depth)	Load (lb)/ft.)	1.5	272	208	164	133
	Load (kg)/m)	1.5	405	310	244	198
	Deflection (in.)	1.5	3.64	4.76	6.01	7.45
	Deflection (mm)	1.5	92.456	120.904	152.654	189.23
	K factor	1.5	0.0129	0.022	0.0352	0.0536

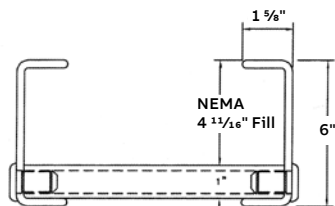

Straight section number selection

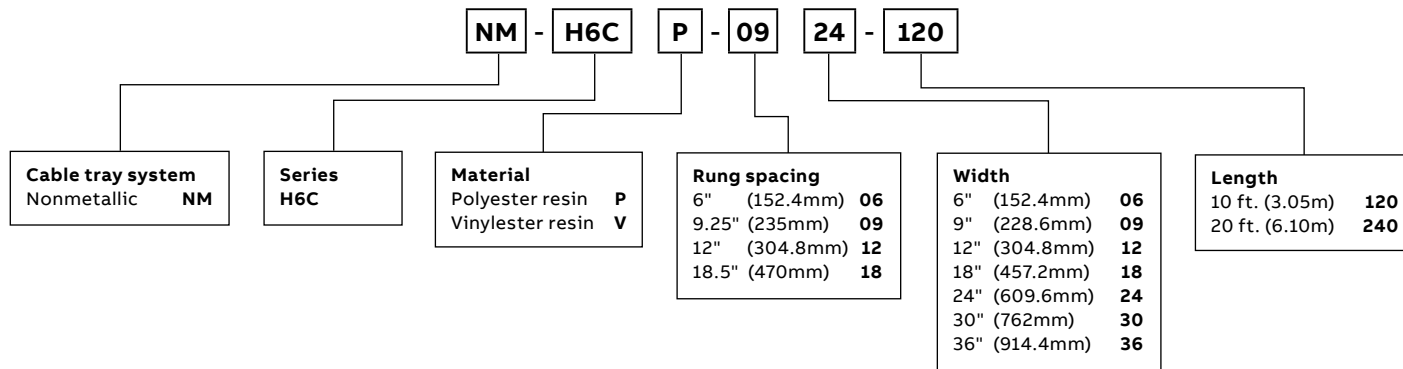

Nonmetallic - Cable tray straight lengths

8" (203.2mm) Straight sections - Series 8



Splice plates

One pair of nonmetallic splice plates with SS6 (316 stainless steel) hardware included.

Deflection factor: To calculate deflection at any span length for lighter loads than listed, multiply the load by the K factor. When trays are used in continuous spans, the deflection of the tray is reduced by as much as 50%.

Loading

- CSA load class: E/6M
- NEMA 20C
- UL Listing load class C

8" (203.2mm) Straight sections – Series 8: Loading - NEMA 20C

Series	Safety Factor	Support span ft. (m)				
		14' (4.3m)	16' (4.9m)	18' (5.5m)	20' (6.1m)	
8	Load (lb)/ft.)	1.5	204	156	123	100
	Load (kg)/m)	1.5	304	233	184	149
	Deflection (in.)	1.5	2.03	3.47	5.47	7.02
	Deflection (mm)	1.5	51.562	88.138	138.938	178.308
	K factor	1.5	0.0057	0.0097	0.0155	0.0236

Side rail height: 8" (203.2mm)
 (6 1/16" (119.1mm) loading depth)

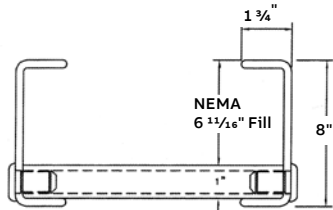

Straight section number selection

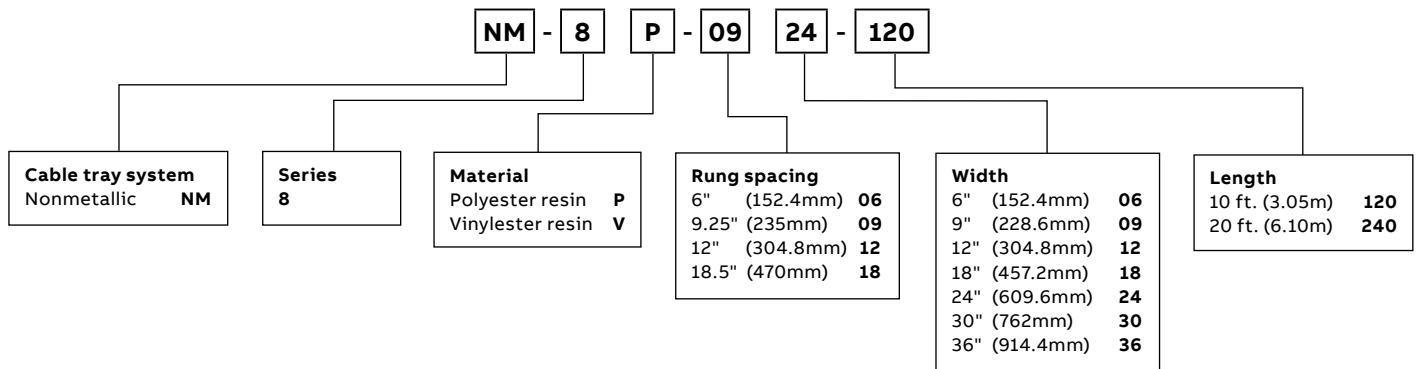

Nonmetallic - Cable tray straight lengths

Marine rung & strut rung cable tray

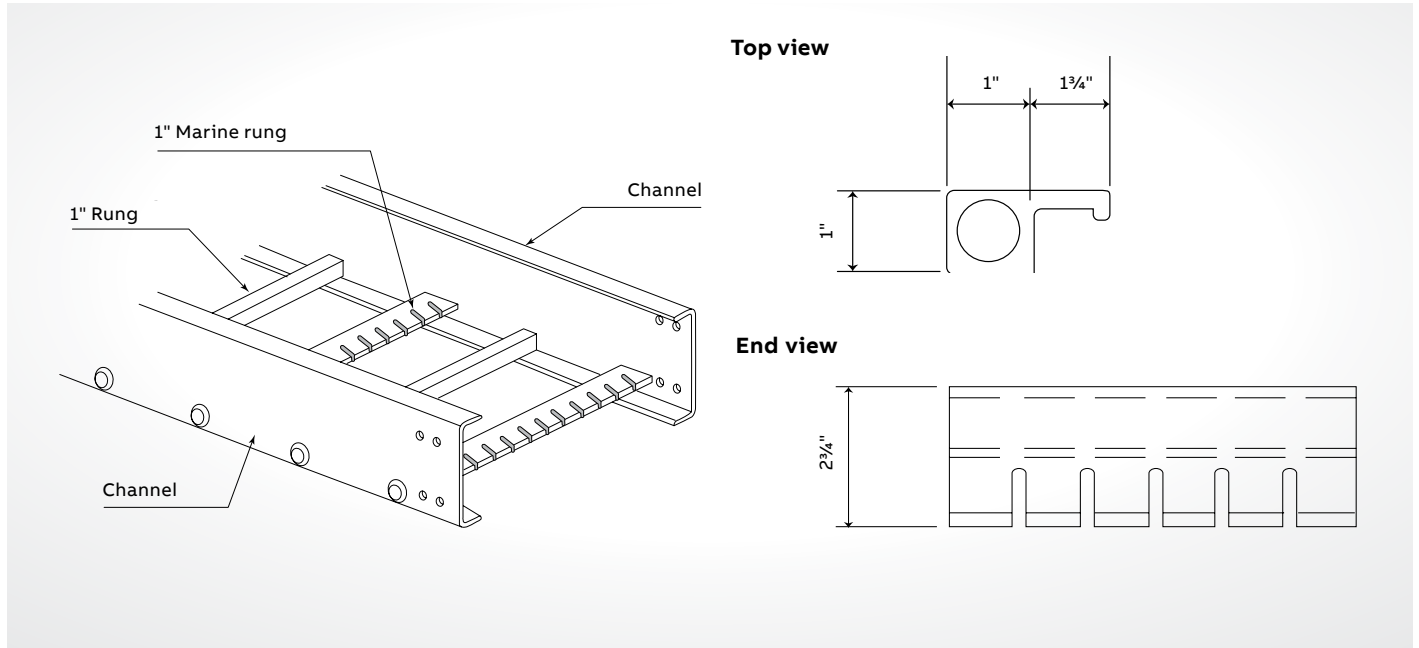

01

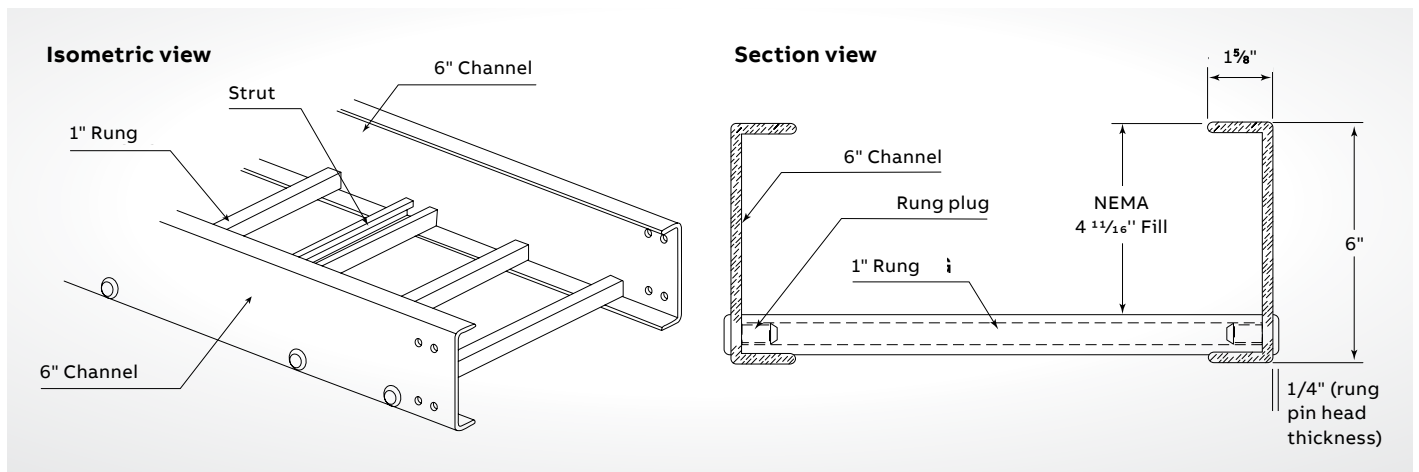

02

- 01 Marine rung cable tray
- 02 Strut rung cable tray

Marine rung cable tray

- Meets U.S. Coast Guard requirements
- **Catalog Number:** Add MR after rung spacing
- **Example:** NM-4P-09MR-24-120
- Call your ABB representative for documentation

Strut rung cable tray

- **Catalog Number:** Add SR after rung spacing
- Call your ABB representative for documentation



Nonmetallic - Cable tray Fittings

NOTE: Splice plates NOT included. See pages B38-B41 for type of splice plates available. Covers are available. Please consult your ABB representative.

Selection guide

1. Nonmetallic cable tray system.
2. For mitered fittings when available.
3. Select height of fitting required for application. This should match tray series and height selection.
4. Select the resin required. Refer to corrosion guide on page B7 of the technical information section for the effect of environmental conditions on the desired material; for the effective temperature range, see page B9 of the same section.
5. Select the desired width in inches.
6. Angle of fitting required for application.
7. Type of fitting required for application. See choices below.
8. Radius required for application. This would be determined by allowable radius of cables being installed. Standard radius is 24" (609.6mm).

Straight fittings number selection

To order

To order a straight section of cable tray, select the appropriate size and material from the charts below and place those symbols in the sequence shown to form the complete catalog number.

Example:

NM-4P0924-120

- 4" (101.6mm) side rail, polyester resin
- 9" (228.6mm) rung spacing
- 24" (609.6mm) wide, 120" (10 ft.) length

NOTE: One pair of nonmetallic splice plates with SS6 hardware included with each length. For other types of splice plates, see pages B38-B41.

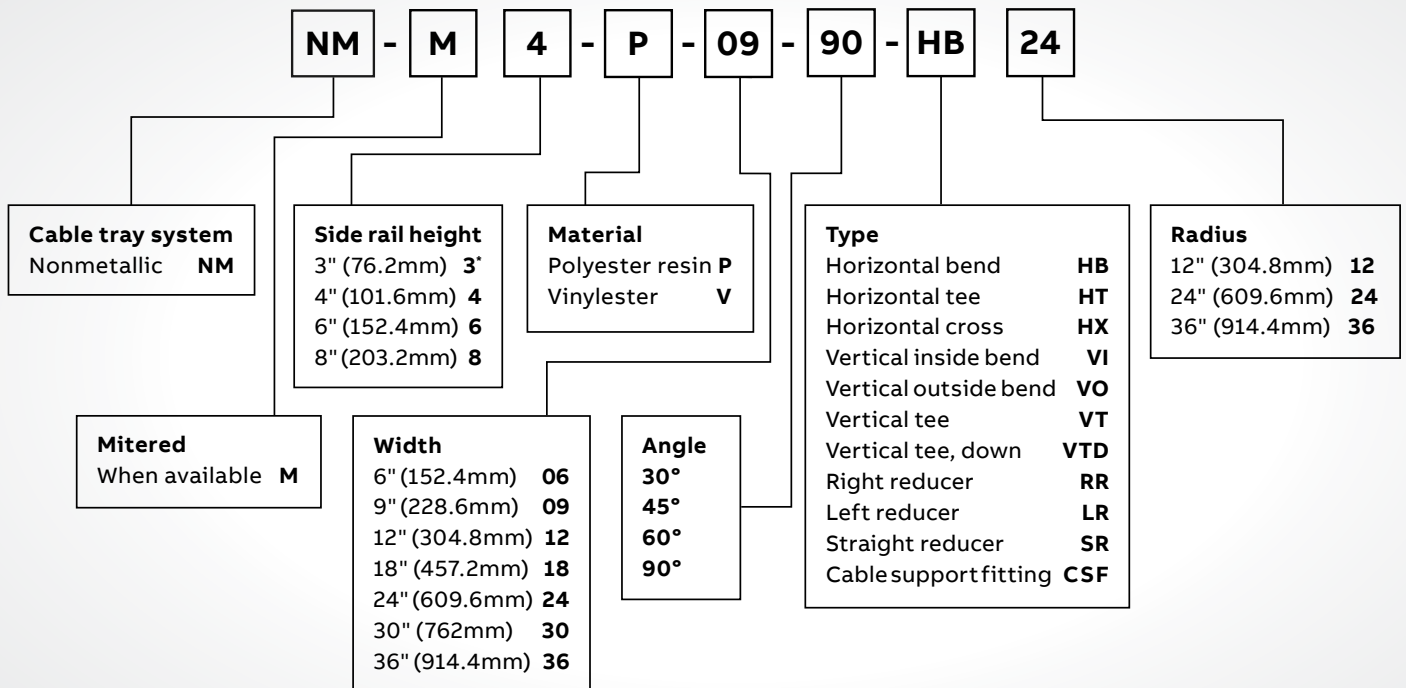

*Series 3 cable tray does not have UL or CSA listing.

Nonmetallic - Cable tray fittings

3" (76.2mm), 4" (101.6mm), 6" (152.4mm) & 8" (203.2mm) - 90° Horizontal bend fittings

90° Horizontal bend

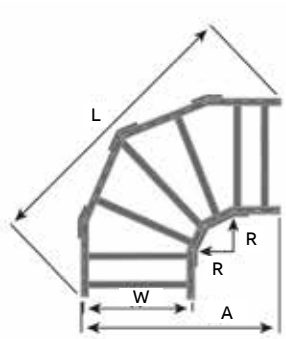

		Bend radius (R)		Tray width (W)				Dimensions		
		(in.)	(mm)	(in.)	(mm)	Cat. No.	A (in.)	A (mm)	L (in.)	L (mm)
12	304.8	6	152.4	NM-M(*)-(Matl)-06-90HB12	33%	854	47½	1,207		
12	304.8	9	228.6	NM-M(*)-(Matl)-09-90HB12	36%	930	51¾	1,314		
12	304.8	12	304.8	NM-M(*)-(Matl)-12-90HB12	39%	1,006	56	1,422		
12	304.8	18	457.2	NM-M(*)-(Matl)-18-90HB12	45%	1,159	64½	1,638		
12	304.8	24	609.6	NM-M(*)-(Matl)-24-90HB12	51%	1,311	73	1,854		
12	304.8	30	762	NM-M(*)-(Matl)-30-90HB12	57%	1,464	81½	2,070		
12	304.8	36	914.4	NM-M(*)-(Matl)-36-90HB12	63%	1,616	90	2,286		
24	609.6	6	152.4	NM-M(*)-(Matl)-06-90HB24	45%	1,159	64½	1,638		
24	609.6	9	228.6	NM-M(*)-(Matl)-09-90HB24	48%	1,235	68¾	1,746		
24	609.6	12	304.8	NM-M(*)-(Matl)-12-90HB24	51%	1,311	73	1,854		
24	609.6	18	457.2	NM-M(*)-(Matl)-18-90HB24	57%	1,464	81½	2,070		
24	609.6	24	609.6	NM-M(*)-(Matl)-24-90HB24	63%	1,616	90	2,286		
24	609.6	30	762	NM-M(*)-(Matl)-30-90HB24	69%	1,768	98½	2,502		
24	609.6	36	914.4	NM-M(*)-(Matl)-36-90HB24	75%	1,921	107	2,718		
36	914.4	6	152.4	NM-M(*)-(Matl)-06-90HB36	57%	1,464	81½	2,070		
36	914.4	9	228.6	NM-M(*)-(Matl)-09-90HB36	60%	1,540	85¾	2,178		
36	914.4	12	304.8	NM-M(*)-(Matl)-12-90HB36	63%	1,616	90	2,286		
36	914.4	18	457.2	NM-M(*)-(Matl)-18-90HB36	69%	1,768	98½	2,502		
36	914.4	24	609.6	NM-M(*)-(Matl)-24-90HB36	75%	1,921	107	2,718		
36	914.4	30	762	NM-M(*)-(Matl)-30-90HB36	81%	2,073	115⅝	2,931		
36	914.4	36	914.4	NM-M(*)-(Matl)-36-90HB36	87%	2,226	123⅞	3,146		

(*) Side Rail Height. One pair of fiberglass splice plates with SS6 hardware included.
 Dimensions for reference only; when critical, contact your ABB representative. Consult your ABB representative for availability of molded fittings.
 Standard rung spacing for fittings is 9¼" nominal (235mm). For other types of splice plates, see pages B38-B41.

Fitting number selection

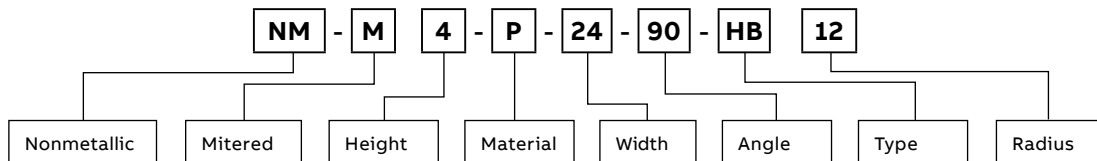

Nonmetallic - Cable tray fittings

3" (76.2mm), 4" (101.6mm), 6" (152.4mm) & 8" (203.2mm) - 45° Horizontal bend fittings

45° Horizontal bend

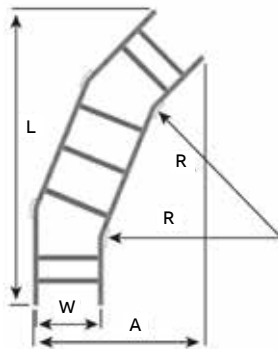

	Bend radius (R)		Tray width (W)		Cat. No.	Dimensions			
	(in.)	(mm)	(in.)	(mm)		A (in.)	A (mm)	L (in.)	L (mm)
12	304.8	6	152.4	NM-M(*)-(Matl)-06-45HB12	20 ^{13/16}	525	38 ^{7/8}	987	
12	304.8	9	228.6	NM-M(*)-(Matl)-09-45HB12	23 ^{13/16}	602	41	1,041	
12	304.8	12	304.8	NM-M(*)-(Matl)-12-45HB12	26 ^{13/16}	678	43 ^{7/8}	1,095	
12	304.8	18	457.2	NM-M(*)-(Matl)-18-45HB12	32 ^{13/16}	830	47 ^{7/8}	1,203	
12	304.8	24	609.6	NM-M(*)-(Matl)-24-45HB12	38 ^{13/16}	983	51 ^{7/8}	1,311	
12	304.8	30	762	NM-M(*)-(Matl)-30-45HB12	44 ^{13/16}	1,135	55 ^{7/8}	1,419	
12	304.8	36	914.4	NM-M(*)-(Matl)-36-45HB12	50 ^{13/16}	1,287	60 ^{7/8}	1,527	
24	609.6	6	152.4	NM-M(*)-(Matl)-06-45HB24	24 ^{1/4}	616	47 ^{3/8}	1,203	
24	609.6	9	228.6	NM-M(*)-(Matl)-09-45HB24	27 ^{1/4}	692	49 ^{1/2}	1,257	
24	609.6	12	304.8	NM-M(*)-(Matl)-12-45HB24	30 ^{1/4}	768	51 ^{5/8}	1,311	
24	609.6	18	457.2	NM-M(*)-(Matl)-18-45HB24	36 ^{1/4}	921	55 ^{7/8}	1,419	
24	609.6	24	609.6	NM-M(*)-(Matl)-24-45HB24	42 ^{1/4}	1,073	60 ^{1/8}	1,527	
24	609.6	30	762	NM-M(*)-(Matl)-30-45HB24	48 ^{1/4}	1,226	64 ^{3/8}	1,635	
24	609.6	36	914.4	NM-M(*)-(Matl)-36-45HB24	54 ^{1/4}	1,378	68 ^{5/8}	1,743	
36	914.4	6	152.4	NM-M(*)-(Matl)-06-45HB36	27 ^{3/4}	705	55 ^{7/8}	1,419	
36	914.4	9	228.6	NM-M(*)-(Matl)-09-45HB36	30 ^{3/4}	781	58	1,473	
36	914.4	12	304.8	NM-M(*)-(Matl)-12-45HB36	33 ^{3/4}	857	60 ^{1/8}	1,527	
36	914.4	18	457.2	NM-M(*)-(Matl)-18-45HB36	39 ^{3/4}	1,010	64 ^{3/8}	1,635	
36	914.4	24	609.6	NM-M(*)-(Matl)-24-45HB36	45 ^{3/4}	1,162	68 ^{5/8}	1,743	
36	914.4	30	762	NM-M(*)-(Matl)-30-45HB36	51 ^{3/4}	1,314	72 ^{13/16}	1,846	
36	914.4	36	914.4	NM-M(*)-(Matl)-36-45HB36	57 ^{3/4}	1,467	77 ^{1/16}	1,957	

(*) Side Rail Height. One pair of fiberglass splice plates with SS6 hardware included.
 Dimensions for reference only; when critical, contact your ABB representative. Consult your ABB representative for availability of molded fittings.
 Standard rung spacing for fittings is 9^{3/4}" nominal (235mm). For other types of splice plates, see pages B38-B41.

Fitting number selection

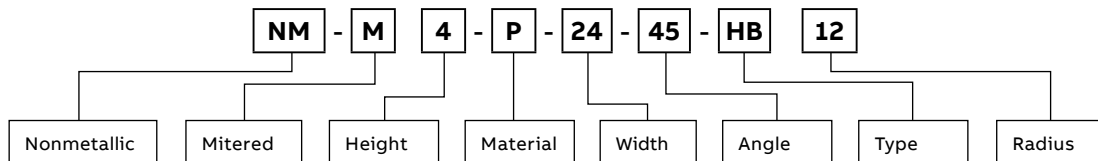

Nonmetallic - Cable tray fittings

3" (76.2mm), 4" (101.6mm), 6" (152.4mm) & 8" (203.2mm) - Horizontal tee fittings

Horizontal tee

	Bend radius (R)		Tray width (W)		Cat. No.	A		Dimensions	
	(in.)	(mm)	(in.)	(mm)		(in.)	(mm)	L (in.)	L (mm)
	12	304.8	6	152.4	NM-M(*)-(Matl)-06-HT12	30%	780	55½	1,410
	12	304.8	9	228.6	NM-M(*)-(Matl)-09-HT12	33%	850	55½	1,410
	12	304.8	12	304.8	NM-M(*)-(Matl)-12-HT12	36%	930	55½	1,410
	12	304.8	18	457.2	NM-M(*)-(Matl)-18-HT12	42%	1,080	64¾	1,640
	12	304.8	24	609.6	NM-M(*)-(Matl)-24-HT12	48%	1,240	74	1,880
	12	304.8	30	762	NM-M(*)-(Matl)-30-HT12	54%	1,390	74	1,880
	12	304.8	36	914.4	NM-M(*)-(Matl)-36-HT12	60%	1,540	83¾	2,110
	24	609.6	6	152.4	NM-M(*)-(Matl)-06-HT24	42%	1,080	74	1,880
	24	609.6	9	228.6	NM-M(*)-(Matl)-09-HT24	45%	1,160	83¾	2,110
	24	609.6	12	304.8	NM-M(*)-(Matl)-12-HT24	48%	1,240	83¾	2,110
	24	609.6	18	457.2	NM-M(*)-(Matl)-18-HT24	54%	1,390	92½	2,350
	24	609.6	24	609.6	NM-M(*)-(Matl)-24-HT24	60%	1,540	92½	2,350
	24	609.6	30	762	NM-M(*)-(Matl)-30-HT24	66%	1,690	101¾	2,580
	24	609.6	36	914.4	NM-M(*)-(Matl)-36-HT24	72%	1,840	111	2,820
	36	914.4	6	152.4	NM-M(*)-(Matl)-06-HT36	54%	1,390	101¾	2,580
	36	914.4	9	228.6	NM-M(*)-(Matl)-09-HT36	57%	1,460	101¾	2,580
	36	914.4	12	304.8	NM-M(*)-(Matl)-12-HT36	60%	1,540	111	2,820
	36	914.4	18	457.2	NM-M(*)-(Matl)-18-HT36	66%	1,690	111	2,820
	36	914.4	24	609.6	NM-M(*)-(Matl)-24-HT36	72%	1,840	120¾	3,050
	36	914.4	30	762	NM-M(*)-(Matl)-30-HT36	78%	2,000	129½	3,290
	36	914.4	36	914.4	NM-M(*)-(Matl)-36-HT36	84%	2,150	129½	3,290

(*) Side Rail Height. Two pairs of fiberglass splice plates with SS6 hardware included.
 Dimensions for reference only; when critical, contact your ABB representative. Consult your ABB representative for availability of molded fittings.
 Standard rung spacing for fittings is 9¾" nominal (235mm). For other types of splice plates, see pages B38-B41.

Fitting number selection

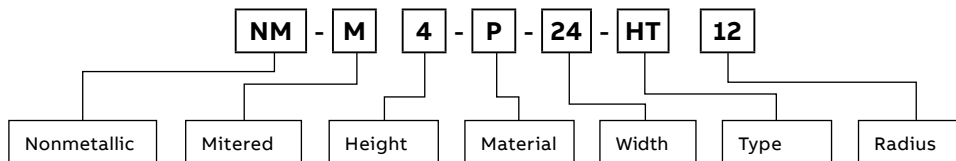

Nonmetallic - Cable tray fittings

3" (76.2mm), 4" (101.6mm), 6" (152.4mm) & 8" (203.2mm) - Horizontal cross fittings

Horizontal cross

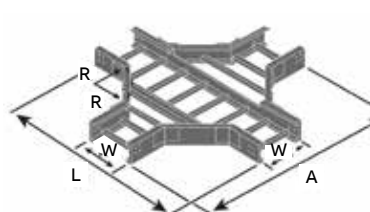

	Bend radius (R)		Tray width (W)		Cat. No.	Dimensions			
	(in.)	(mm)	(in.)	(mm)		A (in.)	A (mm)	L (in.)	L (mm)
	12	304.8	6	152.4	NM-M(*)-(Matl)-06-HX12	54¾	1,390	55½	1,410
	12	304.8	9	228.6	NM-M(*)-(Matl)-09-HX12	57¾	1,470	55½	1,410
	12	304.8	12	304.8	NM-M(*)-(Matl)-12-HX12	60¾	1,540	55½	1,410
	12	304.8	18	457.2	NM-M(*)-(Matl)-18-HX12	66¾	1,700	64¾	1,640
	12	304.8	24	609.6	NM-M(*)-(Matl)-24-HX12	72¾	1,850	74	1,880
	12	304.8	30	762	NM-M(*)-(Matl)-30-HX12	78¾	2,000	74	1,880
	12	304.8	36	914.4	NM-M(*)-(Matl)-36-HX12	84¾	2,150	83¾	2,110
	24	609.6	6	152.4	NM-M(*)-(Matl)-06-HX24	78¾	2,000	74	1,880
	24	609.6	9	228.6	NM-M(*)-(Matl)-09-HX24	81¾	2,080	83¾	2,110
	24	609.6	12	304.8	NM-M(*)-(Matl)-12-HX24	84¾	2,150	83¾	2,110
	24	609.6	18	457.2	NM-M(*)-(Matl)-18-HX24	90¾	2,310	92½	2,350
	24	609.6	24	609.6	NM-M(*)-(Matl)-24-HX24	96¾	2,460	92½	2,350
	24	609.6	30	762	NM-M(*)-(Matl)-30-HX24	102¾	2,610	101¾	2,580
	24	609.6	36	914.4	NM-M(*)-(Matl)-36-HX24	108¾	2,760	111	2,820
	36	914.4	6	152.4	NM-M(*)-(Matl)-06-HX36	102¾	2,610	101¾	2,580
	36	914.4	9	228.6	NM-M(*)-(Matl)-09-HX36	105¾	2,690	101¾	2,580
	36	914.4	12	304.8	NM-M(*)-(Matl)-12-HX36	108¾	2,760	111	2,820
	36	914.4	18	457.2	NM-M(*)-(Matl)-18-HX36	115¾	2,914	111	2,820
	36	914.4	24	609.6	NM-M(*)-(Matl)-24-HX36	120¾	3,070	120¾	3,050
	36	914.4	30	762	NM-M(*)-(Matl)-30-HX36	126¾	3,220	129½	3,290
	36	914.4	36	914.4	NM-M(*)-(Matl)-36-HX36	132¾	3,370	129½	3,290

(*) Side Rail Height. Three pairs of fiberglass splice plates with SS6 hardware included.
 Dimensions for reference only; when critical, contact your ABB representative. Consult your ABB representative for availability of molded fittings.
 Standard rung spacing for fittings is 9¼" nominal (235mm). For other types of splice plates, see pages B38-B41.

Fitting number selection

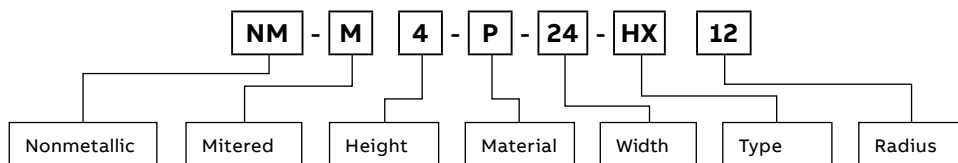

Nonmetallic - Cable tray fittings

3" (76.2mm), 4" (101.6mm), 6" (152.4mm) & 8" (203.2mm) - Horizontal reducer fittings

Horizontal reducer - 4" (101.6mm)

Tray widths

W1 (in.) (mm)	W2 (in.) (mm)	Left-hand reducer Cat. No.	Dim. A (in.)	Dim. L (mm)		
9	228.6	6	152.4	NM-M(*)-(Matl)-09-LR06	27¾	705
12	304.8	6	152.4	NM-M(*)-(Matl)-12-LR06	37	940
12	304.8	9	228.6	NM-M(*)-(Matl)-12-LR09	27¾	705
18	457.2	6	152.4	NM-M(*)-(Matl)-18-LR06	37	940
18	457.2	9	228.6	NM-M(*)-(Matl)-18-LR09	37	940
18	457.2	12	304.8	NM-M(*)-(Matl)-18-LR12	27¾	705
24	609.6	6	152.4	NM-M(*)-(Matl)-24-LR06	46¼	1,175
24	609.6	9	228.6	NM-M(*)-(Matl)-24-LR09	37	940
24	609.6	12	304.8	NM-M(*)-(Matl)-24-LR12	37	940
24	609.6	18	457.2	NM-M(*)-(Matl)-24-LR18	27¾	705
30	762	6	152.4	NM-M(*)-(Matl)-30-LR06	46¼	1,175
30	762	9	228.6	NM-M(*)-(Matl)-30-LR09	46¼	1,175
30	762	12	304.8	NM-M(*)-(Matl)-30-LR12	37	940
30	762	18	457.2	NM-M(*)-(Matl)-30-LR18	37	940
30	762	24	152.4	NM-M(*)-(Matl)-30-LR24	27¾	705
36	914.4	6	152.4	NM-M(*)-(Matl)-36-LR06	55½	1,410
36	914.4	9	228.6	NM-M(*)-(Matl)-36-LR09	46¼	1,175
36	914.4	12	304.8	NM-M(*)-(Matl)-36-LR12	46¼	1,175
36	914.4	18	457.2	NM-M(*)-(Matl)-36-LR18	37	940
36	914.4	24	609.6	NM-M(*)-(Matl)-36-LR24	37	940
36	914.4	30	762	NM-M(*)-(Matl)-36-LR30	27¾	705

Straight reducer Cat. No.	Dim. A (in.)	Dim. L (mm)
NM-M(*)-(Matl)-09-SR06	26¾	670
NM-M(*)-(Matl)-12-SR06	26¾	679
NM-M(*)-(Matl)-12-SR09	26¾	670
NM-M(*)-(Matl)-18-SR06	34½	876
NM-M(*)-(Matl)-18-SR09	33	838
NM-M(*)-(Matl)-18-SR12	26¾	679
NM-M(*)-(Matl)-24-SR06	37½	953
NM-M(*)-(Matl)-24-SR09	36	914
NM-M(*)-(Matl)-24-SR12	36	914
NM-M(*)-(Matl)-24-SR18	26¾	679
NM-M(*)-(Matl)-30-SR06	40½	1,029
NM-M(*)-(Matl)-30-SR09	39	991
NM-M(*)-(Matl)-30-SR12	37½	953
NM-M(*)-(Matl)-30-SR18	35¾	908
NM-M(*)-(Matl)-30-SR24	26¾	679
NM-M(*)-(Matl)-36-SR06	43½	1,105
NM-M(*)-(Matl)-36-SR09	42	1,067
NM-M(*)-(Matl)-36-SR12	40½	1,029
NM-M(*)-(Matl)-36-SR18	37½	953
NM-M(*)-(Matl)-36-SR24	35¾	908
NM-M(*)-(Matl)-36-SR30	26¾	679

Right-hand reducer Cat. No.	Dim. A (in.)	Dim. L (mm)
NM-M(*)-(Matl)-09-RR06	27¾	705
NM-M(*)-(Matl)-12-RR06	37	940
NM-M(*)-(Matl)-12-RR09	27¾	705
NM-M(*)-(Matl)-18-RR06	37	940
NM-M(*)-(Matl)-18-RR09	37	940
NM-M(*)-(Matl)-18-RR12	27¾	705
NM-M(*)-(Matl)-24-RR06	46¼	1,175
NM-M(*)-(Matl)-24-RR09	37	940
NM-M(*)-(Matl)-24-RR12	37	940
NM-M(*)-(Matl)-24-RR18	27¾	705
NM-M(*)-(Matl)-24-RR06	46¼	1,175
NM-M(*)-(Matl)-24-RR09	46¼	1,175
NM-M(*)-(Matl)-24-RR12	37	940
NM-M(*)-(Matl)-24-RR18	37	940
NM-M(*)-(Matl)-18-RR24	27¾	705
NM-M(*)-(Matl)-36-RR06	55½	1,410
NM-M(*)-(Matl)-36-RR09	46¼	1,175
NM-M(*)-(Matl)-36-RR12	46¼	1,175
NM-M(*)-(Matl)-36-RR18	37	940
NM-M(*)-(Matl)-36-RR24	37	940
NM-M(*)-(Matl)-36-RR30	27¾	705

(*) Side Rail Height. One pair of fiberglass splice plates with SS6 hardware included. Dimensions for reference only; when critical, contact your ABB representative. Consult your ABB representative for availability of molded fittings. Standard rung spacing for fittings is 9¼" nominal (235mm). For other types of splice plates, see pages B38-B41.

Dimensions (4" & 6")

Left-hand reducer

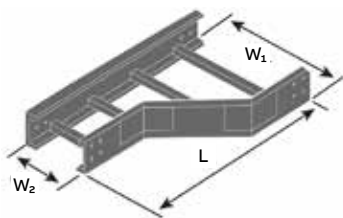

Straight reducer

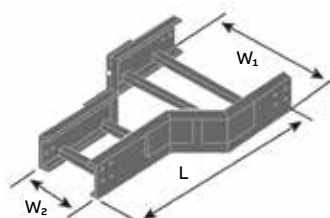

Right hand reducer

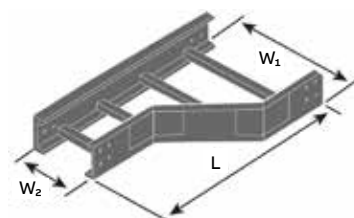

Fitting number selection

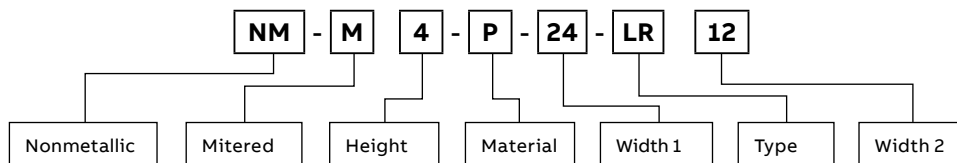

Nonmetallic - Cable tray fittings

3" (76.2mm), 4" (101.6mm), 6" (152.4mm) & 8" (203.2mm) - Horizontal reducing tee fittings

Horizontal reducing tee – 12" (304.8mm) radius

Tray width (W1)					Tray width (W2)		12" (304.8mm) Radius			
(in.) (mm)		(in.) (mm)		Cat. No.	A (in.)	A (mm)	L (in.)	L (mm)		
9	228.6	6	152.4	NM-M(*)-(Matl)-06-06-HT12	30%	777.87	55½	1,409.7		
12	304.8	6	152.4	NM-M(*)-(Matl)-09-06-HT12	33%	854.07	55½	1,409.7		
12	304.8	9	228.6	NM-M(*)-(Matl)-09-09-HT12	33%	854.07	55½	1,409.7		
18	457.2	6	152.4	NM-M(*)-(Matl)-12-06-HT12	36%	930.27	55½	1,409.7		
18	457.2	9	228.6	NM-M(*)-(Matl)-12-09-HT12	36%	930.27	55½	1,409.7		
18	457.2	12	304.8	NM-M(*)-(Matl)-12-12-HT12	36%	930.27	55½	1,409.7		

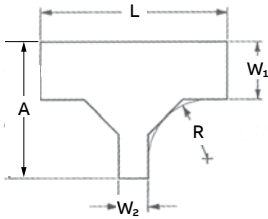

(*) Side Rail Height. Two pairs of fiberglass splice plates with SS6 hardware included. Dimensions for reference only; when critical, contact your ABB representative. Consult your ABB representative for availability of molded fittings. Standard rung spacing for fittings is 9¼" nominal (235mm). For other types of splice plates, see pages B38-B41.

Horizontal reducing tee – 24" (609.6mm) & 36" (914.4mm) radius

Tray width (W1)		Tray width (W2)		Cat. No.	24" (609.6mm) Radius				36" (914.4mm) Radius				
(in.) (mm)		(in.) (mm)			(**) Insert radius 24" or 36"		A (in.)	A (mm)	L (in.)	L (mm)	A (in.)	A (mm)	L (in.)
9	228.6	6	152.4	NM-M(*)-(Matl)-06-06-HT(**)	42%	1,082.55	74	1,879.6	54%	1,387.35	101¾	2,584.45	
12	304.8	6	152.4	NM-M(*)-(Matl)-09-06-HT(**)	45%	1,158.87	74	1,879.6	57%	1,463.55	101¾	2,584.45	
12	304.8	9	228.6	NM-M(*)-(Matl)-09-09-HT(**)	45%	1,158.87	83¾	2,114.55	57%	1,463.55	101¾	2,584.45	
18	457.2	6	152.4	NM-M(*)-(Matl)-12-06-HT(**)	48%	1,235.07	74	1,879.6	60%	1,540.00	101¾	2,584.45	
18	457.2	9	228.6	NM-M(*)-(Matl)-12-09-HT(**)	48%	1,235.07	83¾	2,114.55	60%	1,540.00	101¾	2,584.45	
18	457.2	12	304.8	NM-M(*)-(Matl)-12-12-HT(**)	48%	1,235.07	83¾	2,114.55	60%	1,540.00	111	2,819.4	

(*) Side Rail Height. (**) NOTE: Insert radius, 24" (609.6mm) or 36" (914.4mm). Two pairs of fiberglass splice plates with SS6 hardware included. Dimensions for reference only; when critical, contact your ABB representative. Consult your ABB representative for availability of molded fittings. Standard rung spacing for fittings is 9¼" nominal (235mm). For other types of splice plates, see pages B38-B41.

Sample mitered fitting



Fitting number selection

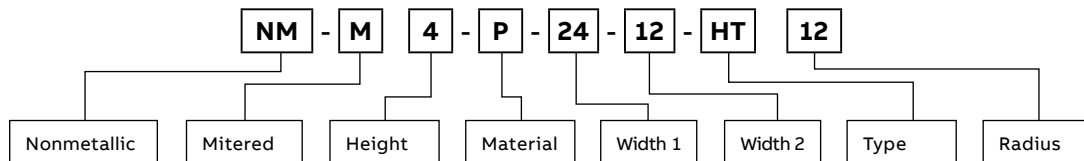

Nonmetallic - Cable tray fittings

3" (76.2mm), 4" (101.6mm), 6" (152.4mm) & 8" (203.2mm) - Horizontal expanding tee fittings

Horizontal expanding tee – 12" (304.8mm) & 24" (609.6mm) radius

Tray width (W1)		Tray width (W2)		Cat. No. (**) Insert radius 12" or 24"	12" (304.8mm) Radius				24" (609.6mm) Radius			
(in.)	(mm)	(in.)	(mm)		A (in.)	A (mm)	B (in.)	B (mm)	A (in.)	A (mm)	B (in.)	B (mm)
9	228.6	12	304.8	NM-M(*)-(Matl)-09-12-HT(**)	33%	854	55½	1,410	45%	1,159	83¼	2,115
9	228.6	18	457.2	NM-M(*)-(Matl)-09-18-HT(**)	33%	854	64¾	1,645	45%	1,159	92½	2,350
9	228.6	24	609.6	NM-M(*)-(Matl)-09-24-HT(**)	33%	854	74	1,880	45%	1,159	92½	2,350
9	228.6	30	762	NM-M(*)-(Matl)-09-30-HT(**)	33%	854	74	1,880	45%	1,159	101¾	2,584
9	228.6	36	914.4	NM-M(*)-(Matl)-09-36-HT(**)	33%	854	83¼	2,115	45%	1,159	111	2,819
12	304.8	18	457.2	NM-M(*)-(Matl)-12-18-HT(**)	36%	930	64¾	1,645	48%	1,235	92½	2,350
12	304.8	24	609.6	NM-M(*)-(Matl)-12-24-HT(**)	36%	930	74	1,880	48%	1,235	92½	2,350
12	304.8	30	762	NM-M(*)-(Matl)-12-30-HT(**)	36%	930	74	1,880	48%	1,235	101¾	2,584
12	304.8	36	914.4	NM-M(*)-(Matl)-12-36-HT(**)	36%	930	83¼	2,115	48%	1,235	111	2,819
18	457.2	24	609.6	NM-M(*)-(Matl)-18-24-HT(**)	42%	1,083	74	1,880	54%	1,387	92½	2,350
18	457.2	30	762	NM-M(*)-(Matl)-18-30-HT(**)	42%	1,083	74	1,880	54%	1,387	101¾	2,584
18	457.2	36	914.4	NM-M(*)-(Matl)-18-36-HT(**)	42%	1,083	83¼	2,115	54%	1,387	111	2,819
24	609.6	30	762	NM-M(*)-(Matl)-24-30-HT(**)	48%	1,235	74	1,880	60%	1,540	101¾	2,584
24	609.6	36	914.4	NM-M(*)-(Matl)-24-36-HT(**)	48%	1,235	83¼	2,115	60%	1,540	111	2,819
30	762	36	914.4	NM-M(*)-(Matl)-30-36-HT(**)	54%	1,387	83¼	2,115	66%	1,692	111	2,819

(*) Side Rail Height. * NOTE: Insert radius, 12" (304.8mm) or 24" (609.6mm). Two pairs of fiberglass splice plates with SS6 hardware included. Dimensions for reference only; when critical, contact your ABB representative. Consult your ABB representative for availability of molded fittings. Standard rung spacing for fittings is 9" (228.6mm). For other types of splice plates, see pages B38-B41.

Dimensions

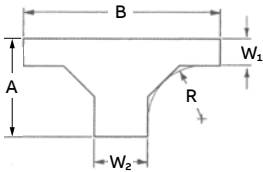

Sample mitered fitting



Fitting number selection

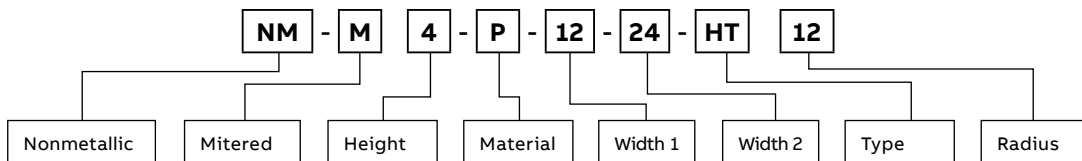

Nonmetallic - Cable tray fittings

3" (76.2mm), 4" (101.6mm), 6" (152.4mm) & 8" (203.2mm) - Horizontal expanding tee fittings

Horizontal expanding tee – 36" (914.4mm) radius

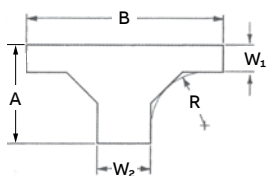

	Tray width (W1)		Tray width (W2)		Cat. No.	36" (914.4mm) Radius			
	(in.)	(mm)	(in.)	(mm)		A (in.)	A (mm)	B (in.)	B (mm)
9	228.6	12	304.8		NM-M(*)-(Matl)-09-12-HT36	57%	1,464	111	2,819
9	228.6	18	457.2		NM-M(*)-(Matl)-09-18-HT36	57%	1,464	111	2,819
9	228.6	24	609.6		NM-M(*)-(Matl)-09-24-HT36	57%	1,464	120¼	3,054
9	228.6	30	609.6		NM-M(*)-(Matl)-09-30-HT36	57%	1,464	129½	3,289
9	228.6	36	762		NM-M(*)-(Matl)-09-36-HT36	57%	1,464	129½	3,289
12	304.8	18	457.2		NM-M(*)-(Matl)-12-18-HT36	60%	1,540	111	2,819
12	304.8	24	609.6		NM-M(*)-(Matl)-12-24-HT36	60%	1,540	120¼	3,054
12	304.8	30	609.6		NM-M(*)-(Matl)-12-30-HT36	60%	1,540	129½	3,289
12	304.8	36	762		NM-M(*)-(Matl)-12-36-HT36	60%	1,540	129½	3,289
18	457.2	24	609.6		NM-M(*)-(Matl)-18-24-HT36	66%	1,692	120¼	3,054
18	457.2	30	609.6		NM-M(*)-(Matl)-18-30-HT36	66%	1,692	129½	3,289
18	457.2	36	762		NM-M(*)-(Matl)-18-36-HT36	66%	1,692	129½	3,289
24	609.6	30	609.6		NM-M(*)-(Matl)-24-30-HT36	72%	1,845	129½	3,289
24	609.6	36	762		NM-M(*)-(Matl)-24-36-HT36	72%	1,845	129½	3,289
30	762	36	762		NM-M(*)-(Matl)-30-36-HT36	78%	1,997	129½	3,289

(*) Side Rail Height. Two pairs of stainless steel SS6 splice plates with SS6 hardware included.
 Dimensions for reference only; when critical, contact your ABB representative. Consult your ABB representative for availability of molded fittings.
 Standard rung spacing for fittings is 9" (228.6mm). For other types of splice plates, see pages B38-B41.

Sample mitered fitting

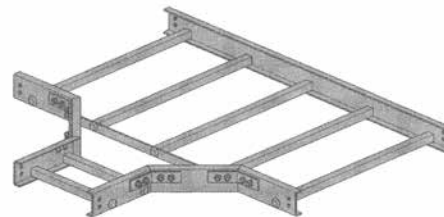

Fitting number selection

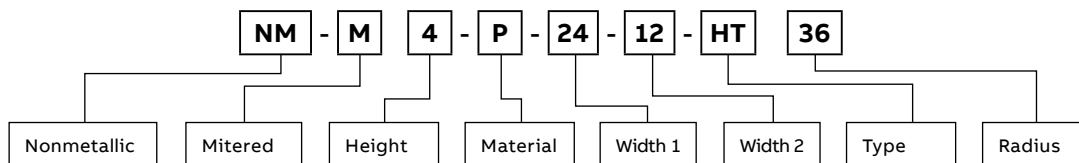

Nonmetallic - Cable tray fittings

3" (76.2mm), 4" (101.6mm), 6" (152.4mm) & 8" (203.2mm) - Horizontal expanding/reducing cross fittings

Horizontal expanding/reducing cross – 12" (304.8mm) & 24" (609.6mm) radius

Tray width (W1)		Tray width (W2)		Cat. No. *Insert radius (12" or 24")	12" (304.8mm) Radius				24" (609.6mm) Radius			
(in.)	(mm)	(in.)	(mm)		A (in.)	A (mm)	B (in.)	B (mm)	A (in.)	A (mm)	B (in.)	B (mm)
6	152.4	9	228.6	NM-M(*)-(Matl)-06-09-HX*	54¾	1,391	55½	1,410	78¾	2,000	83¾	2,115
6	152.4	12	304.8	NM-M(*)-(Matl)-06-12-HX*	54¾	1,391	55½	1,410	78¾	4,972	83¾	2,115
6	152.4	18	457.2	NM-M(*)-(Matl)-06-18-HX*	54¾	1,391	64¾	1,645	78¾	2,000	92½	2,350
6	152.4	24	609.6	NM-M(*)-(Matl)-06-24-HX*	54¾	1,391	74	1,880	78¾	2,000	92½	2,350
6	152.4	30	762	NM-M(*)-(Matl)-06-30-HX*	54¾	1,391	74	1,880	78¾	2,000	101¾	2,584
6	152.4	36	914.4	NM-M(*)-(Matl)-06-36-HX*	54¾	1,391	83¾	2,115	78¾	2,000	111	2,819
9	228.6	12	304.8	NM-M(*)-(Matl)-09-12-HX*	57¾	1,467	55½	1,410	81¾	2,076	83¾	2,115
9	228.6	18	457.2	NM-M(*)-(Matl)-09-18-HX*	57¾	1,467	64¾	1,645	81¾	2,076	92½	2,350
9	228.6	24	609.6	NM-M(*)-(Matl)-09-24-HX*	57¾	1,467	74	1,880	81¾	2,076	92½	2,350
9	228.6	30	762	NM-M(*)-(Matl)-09-30-HX*	57¾	1,467	74	1,880	81¾	2,076	101¾	2,584
9	228.6	36	914.4	NM-M(*)-(Matl)-09-36-HX*	57¾	1,467	83¾	2,115	81¾	2,076	111	2,819
12	304.8	18	457.2	NM-M(*)-(Matl)-12-18-HX*	60¾	1,543	64¾	1,645	84¾	2,153	92½	2,350
12	304.8	24	609.6	NM-M(*)-(Matl)-12-24-HX*	60¾	1,543	74	1,880	84¾	2,153	92½	2,350
12	304.8	30	762	NM-M(*)-(Matl)-12-30-HX*	60¾	1,543	74	1,880	84¾	2,153	101¾	2,584
12	304.8	36	914.4	NM-M(*)-(Matl)-12-36-HX*	60¾	1,543	83¾	2,115	84¾	2,153	111	2,819
18	457.2	24	609.6	NM-M(*)-(Matl)-18-24-HX*	66¾	1,695	74	1,880	90¾	2,305	92½	2,350
18	457.2	30	762	NM-M(*)-(Matl)-18-30-HX*	66¾	1,695	74	1,880	90¾	2,305	101¾	2,584
18	457.2	36	914.4	NM-M(*)-(Matl)-18-36-HX*	66¾	1,695	83¾	2,115	90¾	2,305	111	2,819
24	609.6	30	609.6	NM-M(*)-(Matl)-24-30-HX*	72¾	1,848	74	1,880	96¾	2,457	101¾	2,584
24	609.6	36	914.4	NM-M(*)-(Matl)-24-36-HX*	72¾	1,848	83¾	2,115	96¾	2,457	111	2,819
30	762	36	914.4	NM-M(*)-(Matl)-30-36-HX*	78¾	2,000	83¾	2,115	102¾	2,610	111	2,819

(* Side Rail Height. * NOTE: Insert radius, 12" (304.8mm) or 24" (609.6mm). Three pairs of fiberglass splice plates with SS6 hardware included. Dimensions for reference only; when critical, contact your ABB representative. Consult your ABB representative for availability of molded fittings. Standard rung spacing for fittings is 9¾" nominal (235mm). For other types of splice plates, see pages B38-B41.

Dimensions

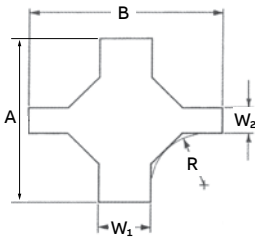

Sample mitered fitting

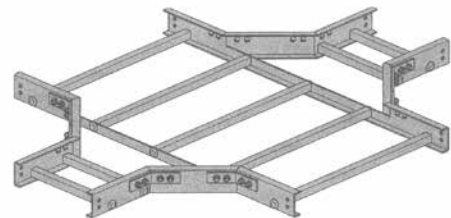

Fitting number selection

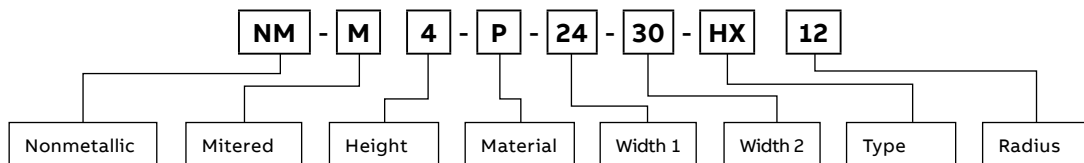

Nonmetallic - Cable tray fittings

3" (76.2mm), 4" (101.6mm), 6" (152.4mm) & 8" (203.2mm) - Horizontal expanding/reducing cross fittings

Horizontal expanding/reducing cross – 36" (914.4mm) radius

	Tray width (W1)		Tray width (W2)		Cat. No.	36" (914.4mm) Radius			
	(in.)	(mm)	(in.)	(mm)		A (in.)	A (mm)	B (in.)	B (mm)
	6	152.4	9	228.6	NM-M(*)-(Matl)-06-09-HX36	102¾	2,610	101¾	2,584
	6	152.4	12	304.8	NM-M(*)-(Matl)-06-12-HX36	102¾	2,610	111	2,819
	6	152.4	18	457.2	NM-M(*)-(Matl)-06-18-HX36	102¾	2,610	111	2,819
	6	152.4	24	609.6	NM-M(*)-(Matl)-06-24-HX36	102¾	2,610	120¾	3,054
	6	152.4	30	609.6	NM-M(*)-(Matl)-06-30-HX36	102¾	2,610	129½	3,289
	6	152.4	36	762	NM-M(*)-(Matl)-06-36-HX36	102¾	2,610	129½	3,289
	9	228.6	12	304.8	NM-M(*)-(Matl)-09-12-HX36	105¾	2,686	111	2,819
	9	228.6	18	457.2	NM-M(*)-(Matl)-09-18-HX36	105¾	2,686	111	2,819
	9	228.6	24	609.6	NM-M(*)-(Matl)-09-24-HX36	105¾	2,686	120¾	3,054
	9	228.6	30	609.6	NM-M(*)-(Matl)-09-30-HX36	105¾	2,686	129½	3,289
9	228.6	36	762	NM-M(*)-(Matl)-09-36-HX36	105¾	2,686	129½	3,289	
12	304.8	18	457.2	NM-M(*)-(Matl)-12-18-HX36	108¾	2,762	111	2,819	
12	304.8	24	609.6	NM-M(*)-(Matl)-12-24-HX36	108¾	2,762	120¾	3,054	
12	304.8	30	609.6	NM-M(*)-(Matl)-12-30-HX36	108¾	2,762	129½	3,289	
12	304.8	36	762	NM-M(*)-(Matl)-12-36-HX36	108¾	2,762	129½	3,289	
18	457.2	24	609.6	NM-M(*)-(Matl)-18-24-HX36	115¾	2,940	120¾	3,054	
18	457.2	30	609.6	NM-M(*)-(Matl)-18-30-HX36	115¾	2,940	129½	3,289	
18	457.2	36	762	NM-M(*)-(Matl)-18-36-HX36	115¾	2,940	129½	3,289	
24	609.6	30	609.6	NM-M(*)-(Matl)-24-30-HX36	120¾	3,067	129½	3,289	
24	609.6	36	762	NM-M(*)-(Matl)-24-36-HX36	120¾	3,067	129½	3,289	
30	762	36	762	NM-M(*)-(Matl)-30-36-HX36	126¾	3,219	129½	3,289	

(*) Side Rail Height. Three pairs of fiberglass splice plates with SS6 hardware included. Dimensions for reference only; when critical, contact your ABB representative. Consult your ABB representative for availability of molded fittings. Standard rung spacing for fittings is 9¼" nominal (235mm). For other types of splice plates, see pages B38-B41.

Sample mitered fitting

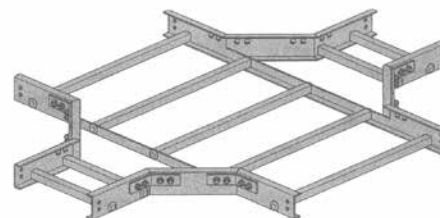

Fitting number selection

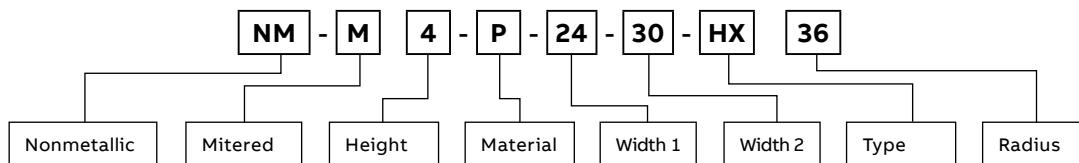

Nonmetallic - Cable tray fittings

3" (76.2mm), 4" (101.6mm), 6" (152.4mm) & 8" (203.2mm) - 90° Vertical inside/ outside bend fittings

90° Vertical inside bend fittings

					Vertical bend 90°				
					Vertical inside bend				
	Bend radius (R)		Tray Height		Cat. No.	A (in.)	A (mm)	L (in.)	L (mm)
	(in.)	(mm)	(in.)	(mm)					
	12	304.8	3	76.2	NM-M3-(Matl)-(*)-90VI12	18 5/16	465	25 15/16	659
	24	609.6			NM-M3-(Matl)-(*)-90VI24	30 5/16	770	42 7/8	1089
	36	914.4			NM-M3-(Matl)-(*)-90VI36	42 5/16	1075	59 7/8	1521
	12	304.8	4	101.6	NM-M4-(Matl)-(*)-90VI12	20 7/8	530	29 1/2	749
	24	609.6			NM-M4-(Matl)-(*)-90VI24	32 7/8	835	46 1/2	1181
	36	914.4			NM-M4-(Matl)-(*)-90VI36	44 5/8	1133	63 5/16	1608
	12	304.8	6	152.4	NM-M6-(Matl)-(*)-90VI12	20 7/8	530	29 1/2	749
	24	609.6			NM-M6-(Matl)-(*)-90VI24	32 7/8	835	46 1/2	1181
	36	914.4			NM-M6-(Matl)-(*)-90VI36	44 5/8	1133	63 5/16	1608
	12	304.8	8	203.2	NM-M8-(Matl)-(*)-90VI12	20 7/8	530	29 1/2	749
	24	609.6			NM-M8-(Matl)-(*)-90VI24	32 7/8	835	46 1/2	1181
	36	914.4			NM-M8-(Matl)-(*)-90VI36	44 5/8	1133	63 5/16	1608

(*) Cable tray Width offered in 6", 9", 12", 18", 24", 30", 36"
 One pair of fiberglass splice plates with SS6 hardware included.
 Dimensions for reference only; when critical, contact your ABB representative. Consult your ABB representative for availability of molded fittings.
 Standard rung spacing for fittings is 9 3/4" nominal (235mm). For other types of splice plates, see pages B38-B41.

90° Vertical outside bend fittings

					Vertical bend 90°				
					Vertical outside bend				
	Bend radius (R)		Tray Height		Cat. No.	A (in.)	A (mm)	L (in.)	L (mm)
	(in.)	(mm)	(in.)	(mm)					
	12	304.8	3	76.2	NM-M3-(Matl)-(*)-90VO12	18 15/16	481	26 3/4	679
	24	609.6			NM-M3-(Matl)-(*)-90VO24	30 15/16	786	43 3/4	1111
	36	914.4			NM-M3-(Matl)-(*)-90VO36	42 15/16	1091	60 11/16	1541
	12	304.8	4	101.6	NM-M4-(Matl)-(*)-90VO12	19 7/8	505	28 1/8	714
	24	609.6			NM-M4-(Matl)-(*)-90VO24	31 7/8	810	45 1/16	1145
	36	914.4			NM-M4-(Matl)-(*)-90VO36	43 7/8	1114	62 1/16	1576
	12	304.8	6	152.4	NM-M6-(Matl)-(*)-90VO12	21 7/8	556	30 15/16	786
	24	609.6			NM-M6-(Matl)-(*)-90VO24	33 7/8	860	47 15/16	1218
	36	914.4			NM-M6-(Matl)-(*)-90VO36	45 7/8	1165	64 7/8	1648
	12	304.8	8	203.2	NM-M8-(Matl)-(*)-90VO12	23 7/8	606	33 3/4	857
	24	609.6			NM-M8-(Matl)-(*)-90VO24	35 7/8	911	50 3/4	1289
	36	914.4			NM-M8-(Matl)-(*)-90VO36	47 7/8	1216	67 3/4	1721

(*) Cable tray Width offered in 6", 9", 12", 18", 24", 30", 36"
 One pair of fiberglass splice plates with SS6 hardware included.
 Dimensions for reference only; when critical, contact your ABB representative. Consult your ABB representative for availability of molded fittings.
 Standard rung spacing for fittings is 9 3/4" nominal (235mm). For other types of splice plates, see pages B38-B41.

Fitting number selection

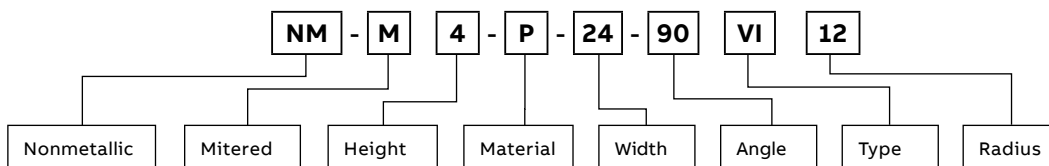

Nonmetallic - Cable tray fittings

3" (76.2mm), 4" (101.6mm), 6" (152.4mm) & 8" (203.2mm) - 45°/30° Vertical inside bend fittings

45° Vertical inside bend

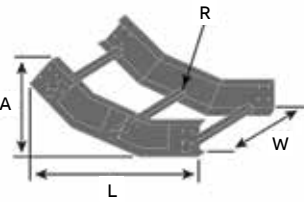
					Vertical bend 45°				
					Vertical inside bend				
	Bend radius (R)		Tray Height		Cat. No.	A (in.)	A (mm)	L (in.)	L (mm)
	(in.)	(mm)	(in.)	(mm)					
	12	304.8	3	76.2	NM-M3-(Matl)-(*)-45VI12	9 3/8	244	18 1/8	459
	24	609.6			NM-M3-(Matl)-(*)-45VI24	13 1/8	333	29 3/8	751
	36	914.4			NM-M3-(Matl)-(*)-45VI36	16 3/8	422	35 1/8	891
	12	304.8	4	101.6	NM-M4-(Matl)-(*)-45VI12	11 1/8	281	19 7/8	505
	24	609.6			NM-M4-(Matl)-(*)-45VI24	14 3/8	371	28 3/8	721
	36	914.4			NM-M4-(Matl)-(*)-45VI36	18 1/8	460	36 7/8	937
	12	304.8	6	152.4	NM-M6-(Matl)-(*)-45VI12	12 1/2	318	19 7/8	505
	24	609.6			NM-M6-(Matl)-(*)-45VI24	16	406	28 3/8	721
	36	914.4			NM-M6-(Matl)-(*)-45VI36	19 1/2	495	36 7/8	937
	12	304.8	8	203.2	NM-M8-(Matl)-(*)-45VI12	13 7/8	352	19 7/8	505
	24	609.6			NM-M8-(Matl)-(*)-45VI24	17 1/8	443	28 3/8	721
	36	914.4			NM-M8-(Matl)-(*)-45VI36	20 1/8	532	36 7/8	937

(*) Cable tray Width offered in 6", 9", 12", 18", 24", 30", 36"

One pair of fiberglass splice plates with SS6 hardware included.

Dimensions for reference only; when critical, contact your ABB representative. Consult your ABB representative for availability of molded fittings.

Standard rung spacing for fittings is 9 3/4" nominal (235mm). For other types of splice plates, see pages B38-B41.

30° Vertical inside bend

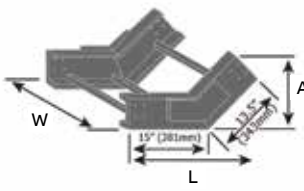
					Vertical bend 30°				
					Vertical inside bend				
	Bend radius (R)		Tray Height		Cat. No.	A (in.)	A (mm)	L (in.)	L (mm)
	(in.)	(mm)	(in.)	(mm)					
	12	304.8	3	76.2	NM-M3-(Matl)-(*)-30VI12	8	203	18	457
	24	609.6			NM-M3-(Matl)-(*)-30VI24	9	229	24	610
	36	914.4			NM-M3-(Matl)-(*)-30VI36	11	279	30	762
	12	304.8	4	101.6	NM-M4-(Matl)-(*)-30VI12	9	229	18	457
	24	609.6			NM-M4-(Matl)-(*)-30VI24	10	254	24	610
	36	914.4			NM-M4-(Matl)-(*)-30VI36	12	305	30	762
	12	304.8	6	152.4	NM-M6-(Matl)-(*)-30VI12	10	254	18	457
	24	609.6			NM-M6-(Matl)-(*)-30VI24	12	305	24	610
	36	914.4			NM-M6-(Matl)-(*)-30VI36	14	356	30	762
	12	304.8	8	203.2	NM-M8-(Matl)-(*)-30VI12	12	305	18	457
	24	609.6			NM-M8-(Matl)-(*)-30VI24	14	356	24	610
	36	914.4			NM-M8-(Matl)-(*)-30VI36	15	381	30	762

(*) Cable tray Width offered in 6", 9", 12", 18", 24", 30", 36"

One pair of fiberglass splice plates with SS6 hardware included.

Dimensions for reference only; when critical, contact your ABB representative. Consult your ABB representative for availability of molded fittings.

Standard rung spacing for fittings is 9 3/4" nominal (235mm). For other types of splice plates, see pages B38-B41.

Fitting number selection

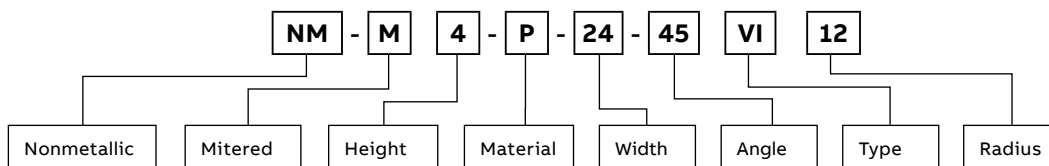

Nonmetallic - Cable tray fittings

3" (76.2mm), 4" (101.6mm), 6" (152.4mm) & 8" (203.2mm) - 35°/45° Vertical outside bend fittings

45° Vertical outside bend

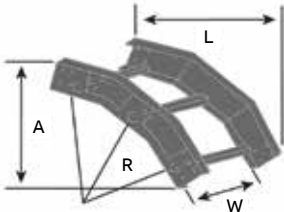
					Vertical bend 45°				
Bend radius (R)		Tray Height		Cat. No.	Vertical outside bend				
(in.)	(mm)	(in.)	(mm)		A (in.)	A (mm)	L (in.)	L (mm)	
	12	304.8	3	76.2	NM-M3-(Matl)-(*)-45VO12	9 ¾	248	18 ½	470
	24	609.6			NM-M3-(Matl)-(*)-45VO24	13 ½	338	27	686
	36	914.4			NM-M3-(Matl)-(*)-45VO36	16 13/16	427	35 ½	902
	12	304.8	4	101.6	NM-M4-(Matl)-(*)-45VO12	10 ¾	273	19 3/16	487
	24	609.6			NM-M4-(Matl)-(*)-45VO24	14 5/16	364	27 1/16	703
	36	914.4			NM-M4-(Matl)-(*)-45VO36	17 13/16	452	36 1/8	918
	12	304.8	6	152.4	NM-M6-(Matl)-(*)-45VO12	12 ¾	324	20 3/16	522
	24	609.6			NM-M6-(Matl)-(*)-45VO24	16 5/16	414	29 1/16	738
	36	914.4			NM-M6-(Matl)-(*)-45VO36	19 13/16	503	37 3/16	954
	12	304.8	8	203.2	NM-M8-(Matl)-(*)-45VO12	14 ¾	375	22	559
	24	609.6			NM-M8-(Matl)-(*)-45VO24	18 5/16	465	30 ½	775
	36	914.4			NM-M8-(Matl)-(*)-45VO36	21 13/16	554	39	991

(*) Cable tray Width offered in 6", 9", 12", 18", 24", 30", 36"

One pair of fiberglass splice plates with SS6 hardware included.

Dimensions for reference only; when critical, contact your ABB representative. Consult your ABB representative for availability of molded fittings.

Standard rung spacing for fittings is 9¾" nominal (235mm). For other types of splice plates, see pages B38-B41.

30° Vertical outside bend

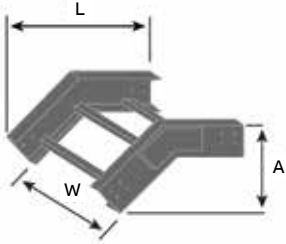
					Vertical bend 30°				
Bend radius (R)		Tray Height		Cat. No.	Vertical outside bend				
(in.)	(mm)	(in.)	(mm)		A (in.)	A (mm)	L (in.)	L (mm)	
	12	304.8	3	76.2	NM-M3-(Matl)-(*)-30VO12	7	178	17	432
	24	609.6			NM-M3-(Matl)-(*)-30VO24	9	229	23	584
	36	914.4			NM-M3-(Matl)-(*)-30VO36	11	279	29	737
	12	304.8	4	101.6	NM-M4-(Matl)-(*)-30VO12	8	203	17	432
	24	609.6			NM-M4-(Matl)-(*)-30VO24	10	254	23	584
	36	914.4			NM-M4-(Matl)-(*)-30VO36	12	305	29	737
	12	304.8	6	152.4	NM-M6-(Matl)-(*)-30VO12	10	254	18	457
	24	609.6			NM-M6-(Matl)-(*)-30VO24	12	305	24	610
	36	914.4			NM-M6-(Matl)-(*)-30VO36	14	356	30	762
	12	304.8	8	203.2	NM-M8-(Matl)-(*)-30VO12	10	254	18	457
	24	609.6			NM-M8-(Matl)-(*)-30VO24	12	305	24	610
	36	914.4			NM-M8-(Matl)-(*)-30VO36	14	356	30	762

(*) Cable tray Width offered in 6", 9", 12", 18", 24", 30", 36"

One pair of fiberglass splice plates with SS6 hardware included.

Dimensions for reference only; when critical, contact your ABB representative. Consult your ABB representative for availability of molded fittings.

Standard rung spacing for fittings is 9¾" nominal (235mm). For other types of splice plates, see pages B38-B41.

Fitting number selection

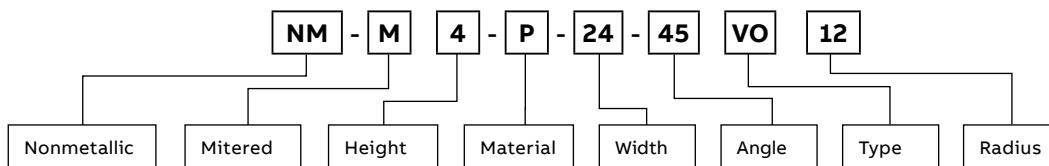

Nonmetallic - Cable tray fittings

3" (76.2mm), 4" (101.6mm), 6" (152.4mm) & 8" (203.2mm) - Vertical tee fittings

Vertical tee

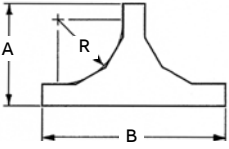
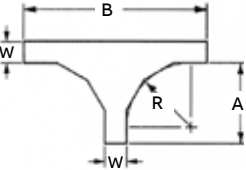
	Bend radius (R)		Tray Height			Vertical tee Up				Vertical tee Down				
	(in.)	(mm)	(in.)	(mm)		A (in.)	A (mm)	B(in)	B(mm)	A (in.)	A (mm)	B(in)	B(mm)	
 VTU vertical tee up	12	304.8	3	76.2	NM-M3-(Matl)-(*)-(**)	12	26 15/16	684	50 7/8	1292	23 15/16	608	50 7/8	1292
	12	304.8			NM-M4-(Matl)-(*)-(**)	12	23 1/4	591	42 1/2	1080	19 1/4	489	42 1/2	1080
	24	609.6	4	101.6	NM-M4-(Matl)-(*)-(**)	24	35 1/4	895	66 1/2	1689	31 3/4	794	66 1/2	1689
	36	914.4			NM-M4-(Matl)-(*)-(**)	36	41 3/4	1060	79 1/2	2019	37 3/4	959	79 1/2	2019
	12	304.8			NM-M6-(Matl)-(*)-(**)	12	32	813	58	1473	26	660	58	1473
	24	609.6	6	152.4	NM-M6-(Matl)-(*)-(**)	24	37 1/4	946	68 1/2	1740	31 1/4	794	68 1/2	1740
 VTD vertical tee down	36	914.4			NM-M6-(Matl)-(*)-(**)	36	49 1/2	1257	92 1/2	2350	43 1/2	1105	92 1/2	2350
	12	304.8			NM-M8-(Matl)-(*)-(**)	12	27 7/8	708	43 3/4	1111	19 1/2	495	43 3/4	1111
	24	609.6	8	203.2	NM-M8-(Matl)-(*)-(**)	24	33 7/8	860	61 3/4	1568	25 1/2	648	61 3/4	1568
	36	914.4			NM-M8-(Matl)-(*)-(**)	36	45 7/8	1165	85 3/4	2178	37 1/2	953	85 3/4	2178

(*) Cable tray Width offered in 6", 9", 12", 18", 24", 30", 36"

(**) Add: "VTD" for vertical tee down or "VTU" for vertical tee up to complete Cat. No. Two pairs of fiberglass splice plates with SS6 hardware included. Standard rung spacing for fittings is 9 1/2" nominal (235mm). For other types of splice plates, see pages 353-355

Fitting number selection

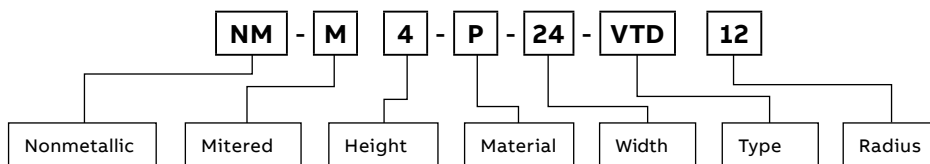

Nonmetallic - Cable tray

Splice plates

01 6" (152.4mm)
Splice plate (comes with nonmetallic hardware)

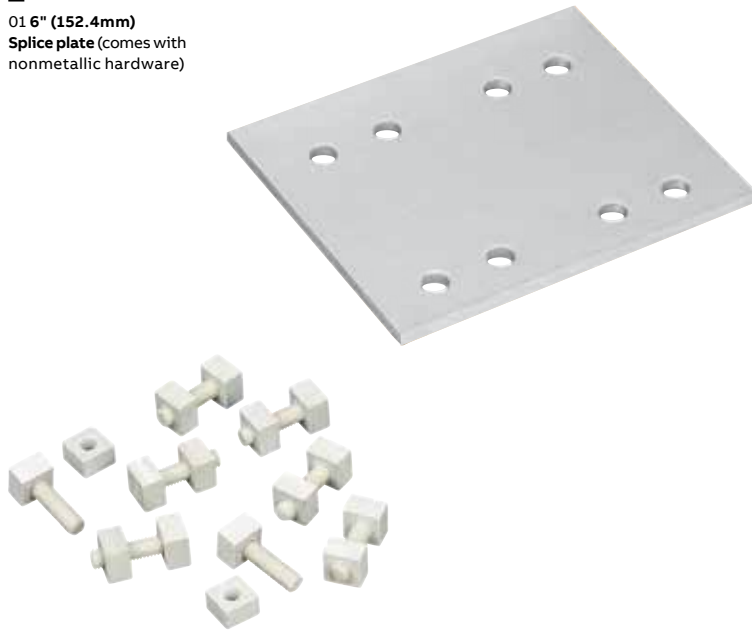

Splice plate number selection

Example:

NM-XSS4004SS6

- 316 stainless steel
- 4 holes supplied with 316 stainless steel hardware for a 4" (101.6mm) deep straight section.

NOTE: Splice plates shown on pages B38-B41 represent splices for 6" (152.4mm) side rail height. Number of holes may vary with other side rail heights.

01

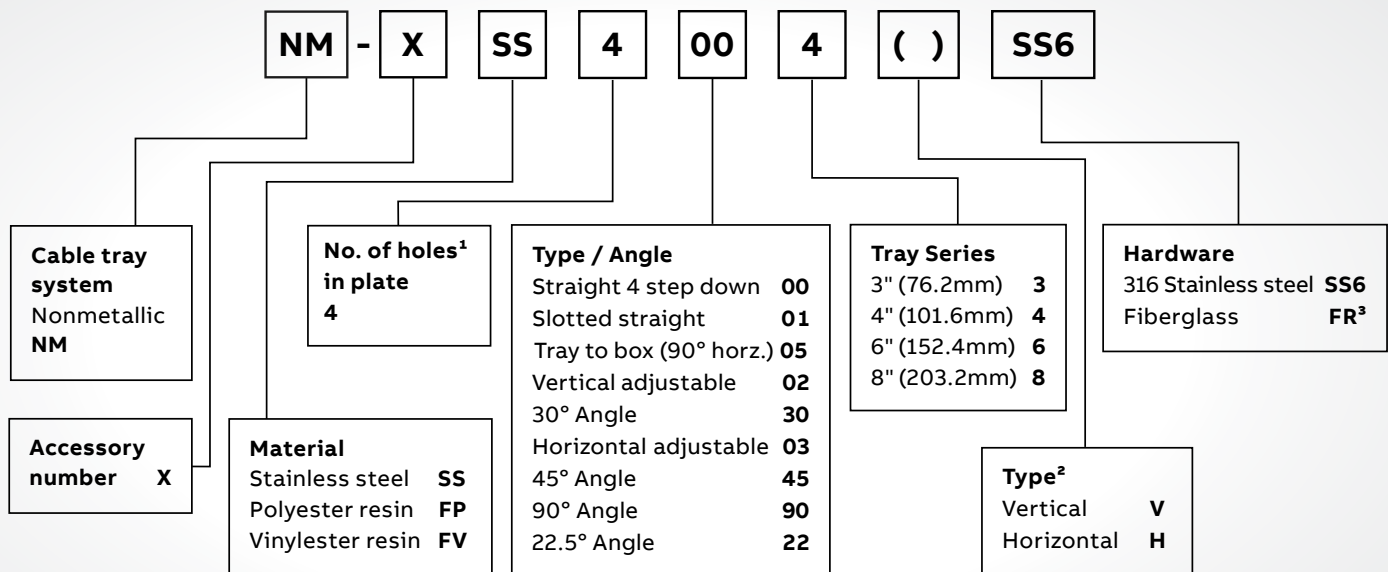

1 : 4 holes for series 3 and 4 only. 8 holes for series 6 and 8 only.
2 : Only noted for angled splice plates, do not include for straight, expansion and adjustable splice plates.
3 : Minimum order quantity of 7 is required.

Nonmetallic - Cable tray

Splice plates

Standard splice plates

	Cat. No.	Material	Height (in.)	Height (mm)
	NM-XSS-8008*	Stainless steel	8	203.2
	NM-XSS-4006*	Polyester resin	6	152.4
	NM-XSS-4004*	Vinylester resin	4	101.6
	NM-XSS-4003*		3	76.2

* Hardware suffix needed to complete catalog number. All splice plate hardware is 3/16". Quantity required supplied with each tray section. Order only pairs of splice plates needed for field modifications. SS6 hardware supplied as standard - use SS6 suffix. Other hardware available; specify by hardware suffix.

Expansion splice plates

	Cat. No.	Material	Height (in.)	Height (mm)
	NM-XSS-8018*	Stainless steel	8	203.2
	NM-XSS-8016*	Polyester resin	6	152.4
	NM-XSS-4014*	Vinylester resin	4	101.6
	NM-XSS-4013*		3	76.2

Allow for up to 1" (25.4mm) expansion or contraction of tray system. For correct gap setting procedure, see page B10.

* Hardware suffix needed to complete catalog number.

Horizontal adjustable splice plates

	Cat. No.	Material	Height (in.)	Height (mm)
	NM-XSS-8038*	Stainless steel	8	203.2
	NM-XSS-4036*	Polyester resin	6	152.4
	NM-XSS-4034*	Vinylester resin	4	101.6
	NM-XSS-4033*		3	76.2

Provide for changes in the horizontal direction that do not conform to standard fittings. Furnished in pairs.

* Hardware suffix needed to complete catalog number.

Vertical adjustable splice plates

	Cat. No.	Material	Height (in.)	Height (mm)
	NM-XSS-8028*	Stainless steel	8	203.2
	NM-XSS-4026*	Polyester resin	6	152.4
	NM-XSS-4024*	Vinylester resin	4	101.6
	NM-XSS-4023*		3	76.2

Provide for changes in elevation that do not conform to standard vertical fittings. Furnished in pairs.

* Hardware suffix needed to complete catalog number.

Nonmetallic - Cable tray

Splice plates

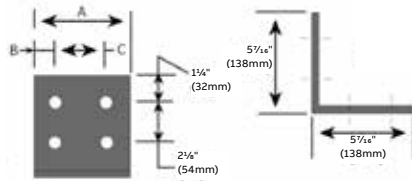

- Used to attach the end of a tray run to a distribution box or control center
- Furnished in pairs

Tray-to-box splice plates

Cat. No.	Cat. No.	Cat. No.	Height (in.)	Height (mm)
Stainless steel	Polyester resin	Vinylester resin		
NM-XSS8058*	NM-XFP8058*	NM-XFV8058*	8	203.2
NM-XSS4056*	NM-XFP4056*	NM-XFV4056*	6	152.4
NM-XSS4054*	NM-XFP4054*	NM-XFV4054*	4	101.6
NM-XSS4053*	NM-XFP4053*	NM-XFV4053*	3	76.2

Hardware other than SS6 is considered special. * Hardware supplied: 1 bolt and 1 springless strut nut 3/8 diameter.



- Easy-to-install design
- Compatible with all series of T&B Cable Tray
- Available in aluminum, pre-galvanized steel, hot-dipped galvanized steel and stainless steel 316
- Versatile use for strut and beam installations
- Functional in all cable tray positions including vertical installations

Combo hold down guide clamp

Cat. No.	Material	Hardware size (in.)	Std. pkg. qty.
SSWCHGC	Stainless steel type 316L	3/8	1
SSWCHGC-HDW*	Stainless steel type 316L	3/8	1

* Hardware supplied: 1 bolt and 1 springless strut nut 3/8 diameter.

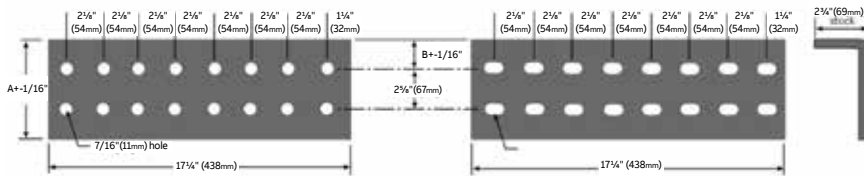

Heavy duty splice plate

Cat. No. Polyester resin	Description	Height (in.)	Height (mm)
NM-ESP-4C-180	Standard Splice Plate	4	101.6
NM-ESP-6C-180		6	152.4
NM-ESP-8C-180		8	203.2
NM-EEP-4C-180	Expansion Splice Plate	4	101.6
NM-EEP-6C-180		6	152.4
NM-EEP-8C-180		8	203.2

Nonmetallic - Cable tray

Splice plates

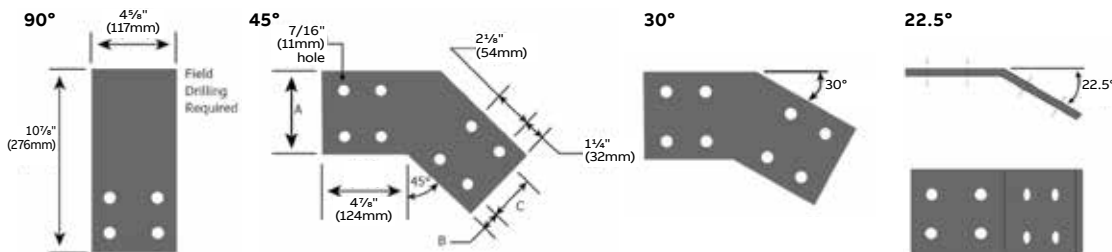

Vertical splice plate

Cat. No. Stainless steel	Cat. No. Polyester resin	Cat. No. Vinylester resin	Height (in.)	Height (mm)
90°				
NM-XSS-8908V*	NM-XFP-8908V*	NM-XFV-8908V*	8	203.2
NM-XSS-8906V*	NM-XFP-8906V*	NM-XFV-8906V*	6	152.4
NM-XSS-4904V*	NM-XFP-4904V*	NM-XFV-4904V*	4	101.6
NM-XSS-4903V*	NM-XFP-4903V*	NM-XFV-4903V*	3	76.2
45°				
NM-XSS-8458V*	NM-XFP-8458V*	NM-XFV-8458V*	8	203.2
NM-XSS-8456V*	NM-XFP-8456V*	NM-XFV-8456V*	6	152.4
NM-XSS-4454V*	NM-XFP-4454V*	NM-XFV-4454V*	4	101.6
NM-XSS-4453V*	NM-XFP-4453V*	NM-XFV-4453V*	3	76.2

* Hardware suffix needed to complete catalog number.

Cat. No. Stainless steel	Cat. No. Polyester resin	Cat. No. Vinylester resin	Height (in.)	Height (mm)
30°				
NM-XSS-8308V*	NM-XFP-8308V*	NM-XFV-8308V*	8	203.2
NM-XSS-8306V*	NM-XFP-8306V*	NM-XFV-8306V*	6	152.4
NM-XSS-4304V*	NM-XFP-4304V*	NM-XFV-4304V*	4	101.6
NM-XSS-4303V*	NM-XFP-4303V*	NM-XFV-4303V*	3	76.2
22.5°				
NM-XSS-8228V*	NM-XFP-8228V*	NM-XFV-8228V*	6	152.4
NM-XSS-8226V*	NM-XFP-8226V*	NM-XFV-8226V*	6	152.4
NM-XSS-4224V*	NM-XFP-4224V*	NM-XFV-4224V*	4	101.6
NM-XSS-4223V*	NM-XFP-4223V*	NM-XFV-4223V*	3	76.2

* Hardware suffix needed to complete catalog number.

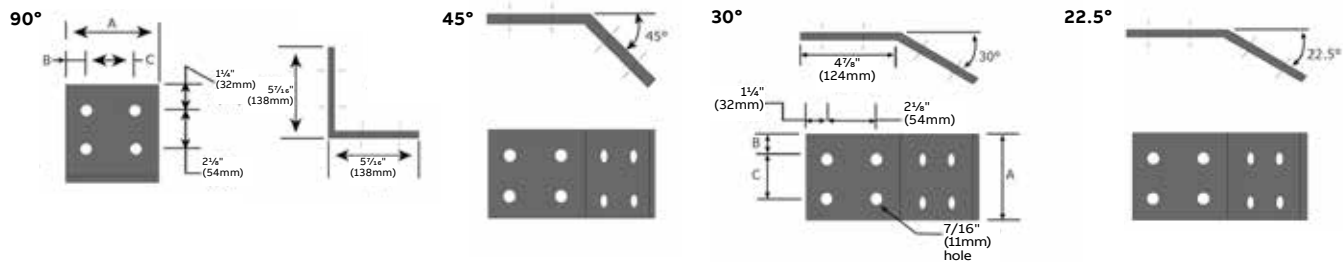

Horizontal splice plates

Cat. No. Stainless steel	Cat. No. Polyester resin	Cat. No. Vinylester resin	Height (in.)	Height (mm)
90°				
NM-XSS-8908H*	NM-XFP-8908H*	NM-XFV-8908H*	8	203.2
NM-XSS-8906H*	NM-XFP-8906H*	NM-XFV-8906H*	6	152.4
NM-XSS-4904H*	NM-XFP-4904H*	NM-XFV-4904H*	4	101.6
NM-XSS-4903H*	NM-XFP-4903H*	NM-XFV-4903H*	3	76.2
45°				
NM-XSS-8458H*	NM-XFP-8458H*	NM-XFV-8458H*	8	203.2
NM-XSS-8456H*	NM-XFP-8456H*	NM-XFV-8456H*	6	152.4
NM-XSS-4454H*	NM-XFP-4454H*	NM-XFV-4454H*	4	101.6
NM-XSS-4453H*	NM-XFP-4453H*	NM-XFV-4453H*	3	76.2

* Hardware suffix needed to complete catalog number.

Cat. No. Stainless steel	Cat. No. Polyester resin	Cat. No. Vinylester resin	Height (in.)	Height (mm)
30°				
NM-XSS-8308H*	NM-XFP-8308H*	NM-XFV-8308H*	8	203.2
NM-XSS-8306H*	NM-XFP-8306H*	NM-XFV-8306H*	6	152.4
NM-XSS-4304H*	NM-XFP-4304H*	NM-XFV-4304H*	4	101.6
NM-XSS-4303H*	NM-XFP-4303H*	NM-XFV-4303H*	3	76.2
22.5°				
NM-XSS-8228H*	NM-XFP-8228H*	NM-XFV-8228H*	6	152.4
NM-XSS-8226H*	NM-XFP-8226H*	NM-XFV-8226H*	6	152.4
NM-XSS-4224H*	NM-XFP-4224H*	NM-XFV-4224H*	4	101.6
NM-XSS-4223H*	NM-XFP-4223H*	NM-XFV-4223H*	3	76.2

* Hardware suffix needed to complete catalog number.

Nonmetallic - Cable tray systems

Drop outs and barrier strips

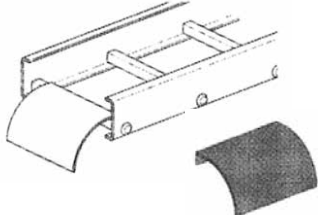

Ladder drop out

Specially designed ladder drop outs provide a rounded surface with adequate radius to protect cable as it exits from the tray, preventing damage to insulation.

Cat. No.	Material
NM-XDOP1104-W*	Pultruded fiberglass

* Supplied with a 4in. Radius
W = Tray width.

Barriers

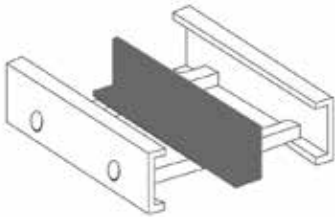

Cat. No.	Material	Side rail height (in.)	Side rail height (mm)
NM-BS08P-120	Polyester resin	8	203.2
NM-BS06P-120	Polyester resin	6	152.4
NM-BS04P-120	Polyester resin	4	101.6
NM-BS03P-120	Polyester resin	3	76.2
NM-BS08V-120	Vinylester resin	8	203.2
NM-BS06V-120	Vinylester resin	6	152.4
NM-BS04V-120	Vinylester resin	4	101.6
NM-BS03V-120	Vinylester resin	3	76.2

Barriers are provided in 10 ft. lengths and supplied for field installation using 3/16" SS rivets (ref. part # TPDR) or use of an adjustable clamp ref. part # XXX (for 3, 4, 6 and 8" deep ladder tray).

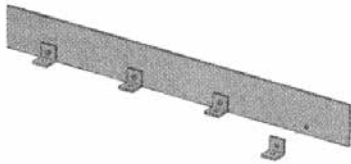

Flexible horizontal barrier kit

Kit contents

- 1 pc. 72" (1,828.8mm) straight barrier
- 4 pc. XF-9002 barrier strip clip
- 8 pc. SS6 pop rivets
- 4 pc. #10 x 3/4" stainless steel self-tapping screw
- Assembly required - directions included

Cat. No.	Material	Side rail height (in.)	Side rail height (mm)	Loading depth (in.)	Loading depth (mm)
NM-BS08P-90HBFL	Polyester resin	8	203.2	6 ¹¹ / ₁₆	169.86
NM-BS06P-90HBFL	Polyester resin	6	152.4	4 ¹¹ / ₁₆	119.06
NM-BS04P-90HBFL	Polyester resin	4	101.6	2 ¹¹ / ₁₆	68.26
NM-BS03P-90HBFL	Polyester resin	3	76.2	1 ³ / ₄	44.45
NM-BS08V-90HBFL	Vinylester resin	8	203.2	6 ¹¹ / ₁₆	169.86
NM-BS06V-90HBFL	Vinylester resin	6	152.4	4 ¹¹ / ₁₆	169.86
NM-BS04V-90HBFL	Vinylester resin	4	101.6	2 ¹¹ / ₁₆	68.26
NM-BS03V-90HBFL	Vinylester resin	3	76.2	1 ³ / ₄	44.45

One kit allows up to 38 (965.2mm) radius position of the barrier.
For larger than 38 (965.2mm) radius barrier position, two kits are required.

Nonmetallic - Cable tray systems

Barrier strips and blind end plates

Barrier mounting angle clips with fasteners

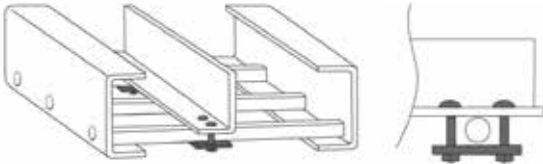
	Cat. No.	Material
	NM-PK-BAC	Pultruded fiberglass (polyester & vinylester)

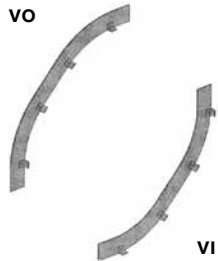

Vertical barrier

- Barriers for vertical fitting
- Please add angle (X) and radius (r) to catalog number
- Furnished with #10 x 3/4" self-tapping stainless steel screws

Cat. No.	Material	Height (in.)	Height (mm)
NM-BS08P(X)VI/VO	Polyester resin	8	203.2
NM-BS06P(X)VI/VO	Polyester resin	6	152.4
NM-BS04P(X)VI/VO	Polyester resin	4	101.6
NM-BS03P(X)VI/VO	Polyester resin	3	76.2
NM-BS08V(X)VI/VO	Vinylester resin	8	203.2
NM-BS06V(X)VI/VO	Vinylester resin	6	152.4
NM-BS04V(X)VI/VO	Vinylester resin	4	101.6
NM-BS03V(X)VI/VO	Vinylester resin	3	76.2

VI = inside vertical, VO = outside vertical.

Blind end plates

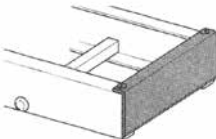
	Cat. No.	Material	Height (in.)	Height (mm)
	NM-XBE*1088W**	Polyester/ Vinylester	8	203.2
	NM-XBE*1086W**	Polyester/ Vinylester	6	152.4
	NM-XBE*1084W**	Polyester/ Vinylester	4	101.6
	NM-XBE*1083W**	Polyester/ Vinylester	3	76.2

Forms a closure for any tray that dead ends. Furnished as one plate.

* Material suffix, P=Polyester, V= Vinylester. ** Hardware suffix needed to complete catalog number.

W = Tray width

Nonmetallic - Cable tray covers

Covers

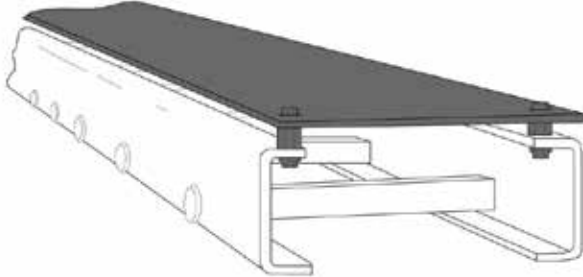

Covers for straight sections

- Material thickness: 1/8" (3.18mm)
- Standard cover length: 120" (10 ft.)
- 1/4" (6.35mm) diameter stainless fasteners with flat washers included

Covers for fittings

- Material thickness: 1/8" (3.18mm)
- 1/4" (6.35mm) diameter stainless fasteners with flat washers included

Covers for straight sections - Selection guide

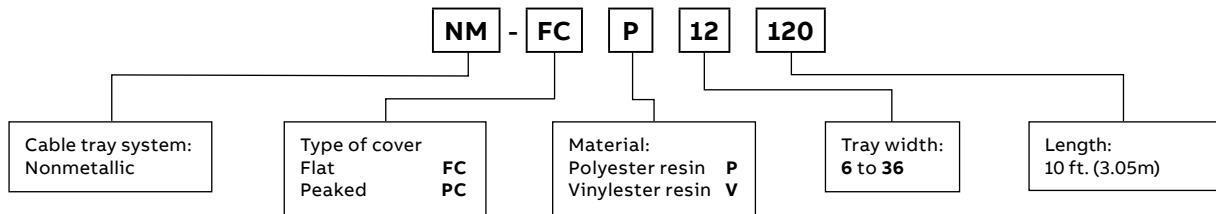

Covers for fittings - Selection guide

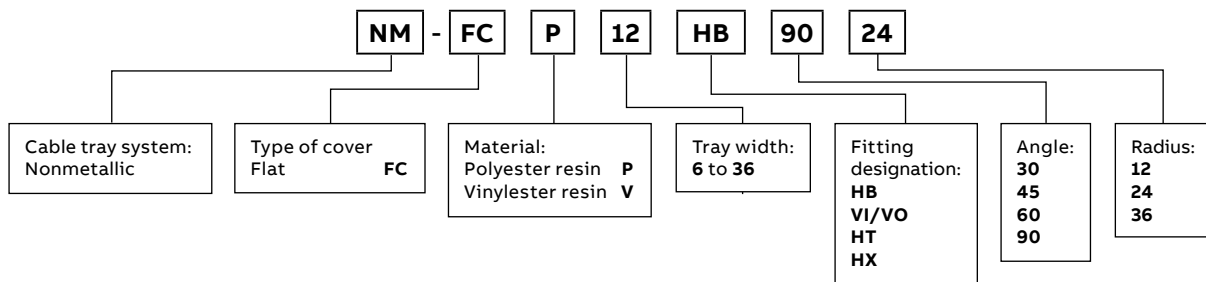

NOTE: Peaked fitting covers not available. Other fitting covers are available. Please consult your ABB representative.

Nonmetallic - Cable tray

Accessories

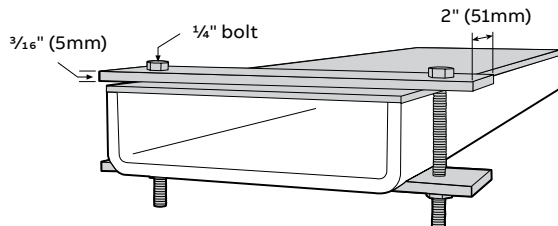

Heavy-duty cover clamp

- Recommended for outdoor service
- Heavy-duty cover clamp available for flat covers only
- Available in stainless steel only

Cat. No.	Material	Side rail width (in.)	Side rail width (mm)
NM-XWC-P-08-9034	Stainless steel	8	203.2
NM-XWC-P-W6-9034		6	152.4
NM-XWC-P-04-9034		4	101.6
NM-XWC-P-03-9034		3	76.2

Pop rivets

	Cat. No.	Material
	TPDR	Stainless steel
		Thermoplastic

Raised cover clamps available.
Please consult your ABB representative.



Kit contents

- Resin
- Catalyst
- Stir stick and applicator

Brush-on resin seal kit

Cat. No.	Description
NM-RSK-QT	946 ml

To reseal fiberglass after field modifications.
Vinylester resin.

Nonmetallic - Channel tray

Straight lengths

NOTE: Splice plates NOT included. See pages B38-B41 for type of splice plates available. Covers are available. Please consult your ABB representative.

Channel tray

ABB offers nonmetallic cable channel in solid or ventilated straight sections. Horizontal and vertical solid bottom fittings are also available to complete your system layout.

Channel tray fitting selection

Example:

NM-FCCVP04-120 for polyester resin cable channel, 4" (101.6mm) wide ventilated bottom, 120" (10 ft. / 3.05m) length. NOTE: Straights are provided without splice plate.



Specifications - Ventilated

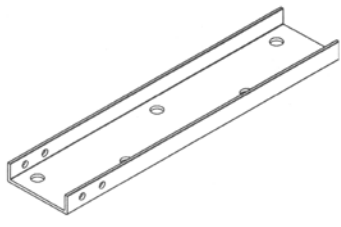

	Width		Height		Length		Material	
	(in.)	(mm)	(in.)	(mm)	(ft.)	(m)	Polyester	Vinylester
	3	76.2	1	25.4	10	3.05	NM-FCCVP-03-120	NM-FCCVV-03-120
	3	76.2	1	25.4	20	6.10	NM-FCCVP-03-240	NM-FCCVV-03-240
	4	101.6	1½	28.6	10	3.05	NM-FCCVP-04-120	NM-FCCVV-04-120
	4	101.6	1½	28.6	20	6.10	NM-FCCVP-04-240	NM-FCCVV-04-240
	6	152.4	1¾	41.3	10	3.05	NM-FCCVP-06-120	NM-FCCVV-06-120
	6	152.4	1¾	41.3	20	6.10	NM-FCCVP-06-240	NM-FCCVV-06-240
	8	203.2	2¾	55.6	10	3.05	NM-FCCVP-08-120	NM-FCCVV-08-120
	8	203.2	2¾	55.6	20	6.10	NM-FCCVP-08-240	NM-FCCVV-08-240

Specifications - Non-ventilated

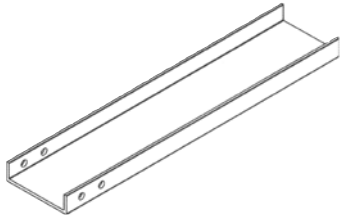

	Width		Height		Length		Material	
	(in.)	(mm)	(in.)	(mm)	(ft.)	(m)	Polyester	Vinylester
	3	76.2	1	25.4	10	3.05	NM-FCCNP-03-120	NM-FCCNV-03-120
	3	76.2	1	25.4	20	6.10	NM-FCCNP-03-240	NM-FCCNV-03-240
	4	101.6	1½	28.6	10	3.05	NM-FCCNP-04-120	NM-FCCNV-04-120
	4	101.6	1½	28.6	20	6.10	NM-FCCNP-04-240	NM-FCCNV-04-240
	6	152.4	1¾	41.3	10	3.05	NM-FCCNP-06-120	NM-FCCNV-06-120
	6	152.4	1¾	41.3	20	6.10	NM-FCCNP-06-240	NM-FCCNV-06-240
	8	203.2	2¾	55.6	10	3.05	NM-FCCNP-08-120	NM-FCCNV-08-120
	8	203.2	2¾	55.6	20	6.10	NM-FCCNP-08-240	NM-FCCNV-08-240

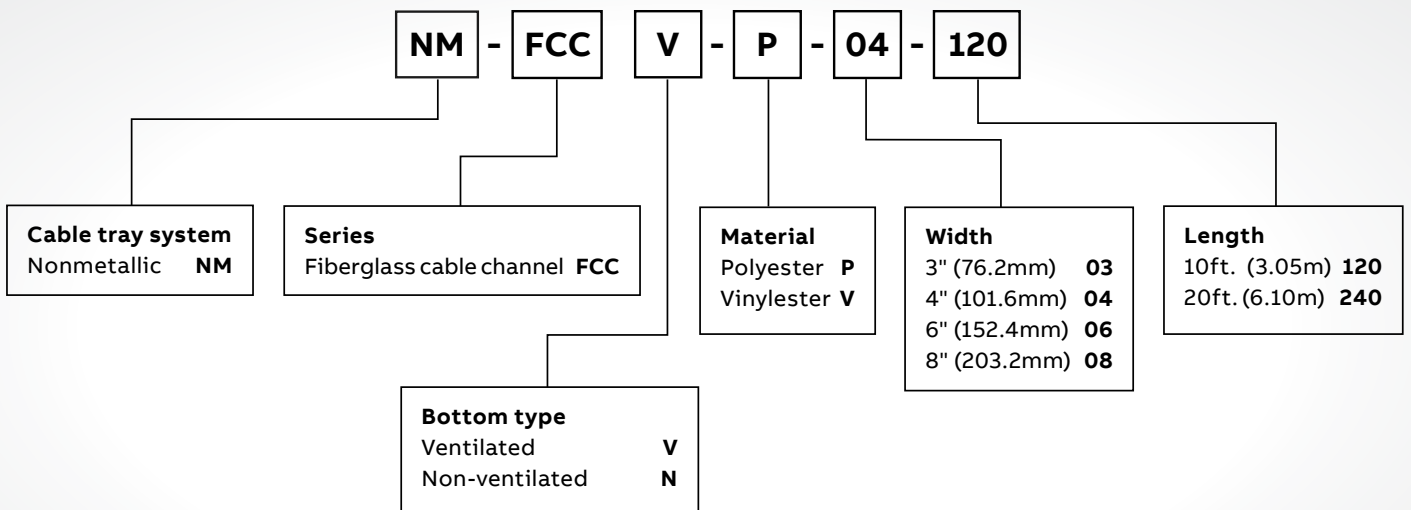

Nonmetallic - Channel tray fittings

Horizontal bends and vertical bend fittings

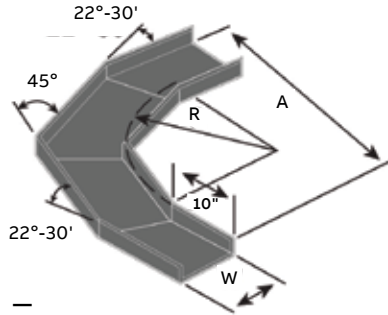

Horizontal bends

- One pair of splice plates included
- For vinylester resin, use “V” instead of “P” in catalog number
- Example: FCCNV-04-90HB12

Cat. No.	Material	Angle	Side rail width (in.)	Side rail width (mm)
NM-FCCNP-03-90HB12	Polyester / Vinylester resin	90°	3	76.2
NM-FCCNP-04-90HB12	Polyester / Vinylester resin	90°	4	101.6
NM-FCCNP-06-90HB12	Polyester / Vinylester resin	90°	6	152.4
NM-FCCNP-08-90HB12	Polyester / Vinylester resin	90°	8	203.2
NM-FCCNP-03-45HB12	Polyester / Vinylester resin	45°	4	76.2
NM-FCCNP-04-45HB12	Polyester / Vinylester resin	45°	4	101.6
NM-FCCNP-06-45HB12	Polyester / Vinylester resin	45°	6	152.4
NM-FCCNP-08-45HB12	Polyester / Vinylester resin	45°	8	203.2

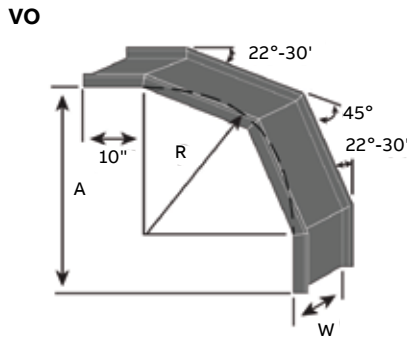

Vertical bends

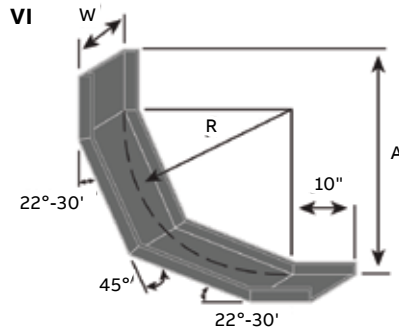

- One pair of splice plates included
- For vinylester resin, use “V” instead of “P” in catalog number
- Example: FCCNV-04-90VI12

Cat. No.	Material	Angle	Side rail width (in.)	Side rail width (mm)
NM-FCCNP-03-90VI12*	Polyester / Vinylester resin	90°	3	76.2
NM-FCCNP-04-90VI12*	Polyester / Vinylester resin	90°	4	101.6
NM-FCCNP-06-90VI12*	Polyester / Vinylester resin	90°	6	152.4
NM-FCCNP-08-90VI12*	Polyester / Vinylester resin	90°	8	203.2
NM-FCCNP-03-45VI12*	Polyester / Vinylester resin	45°	4	76.2
NM-FCCNP-04-45VI12*	Polyester / Vinylester resin	45°	4	101.6
NM-FCCNP-06-45VI12*	Polyester / Vinylester resin	45°	6	152.4
NM-FCCNP-08-45VI12*	Polyester / Vinylester resin	45°	8	203.2

* For vertical outside bends, replace VI with VO

Nonmetallic - Channel tray fittings

Horizontal tee and cross fittings

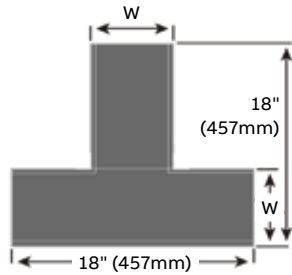

Horizontal tees

Cat. No.	Material	Side rail width (in.)	Side rail width (mm)
NM-FCCNP-03-HT12	Polyester / Vinylester resin	3	76.2
NM-FCCNP-04-HT12	Polyester / Vinylester resin	4	101.6
NM-FCCNP-06-HT12	Polyester / Vinylester resin	6	152.4
NM-FCCNP-08-HT12	Polyester / Vinylester resin	8	203.2

- Two pairs of splice plates included
- For vinylester resin, use “V” instead of “P” in catalog number
- Example: FCCNV-04-HT12

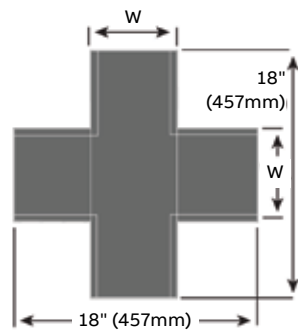

Horizontal crosses

Cat. No.	Material	Side rail height (in.)	Side rail height (mm)
NM-FCCNP-03-HX12	Polyester / Vinylester resin	3	76.2
NM-FCCNP-04-HX12	Polyester / Vinylester resin	4	101.6
NM-FCCNP-06-HX12	Polyester / Vinylester resin	6	152.4
NM-FCCNP-08-HX12	Polyester / Vinylester resin	8	203.2

- Three pairs of splice plates included
- For vinylester resin, use “V” instead of “P” in catalog number
- Example: FCCNV-04-HX12

Nonmetallic - Channel tray systems

Standard and horizontal 90°, 45°, 30° & 22.5° splice plates

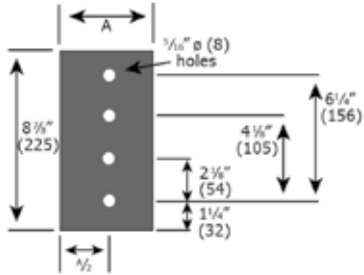

Standard splice plates

Cat. No.	Material
NM-XSS-1001-SS6	Stainless steel
NM-XFP-1001-SS6	Polyester resin
NM-XFV-1001-SS6	Vinylester resin

Supplied in pairs. Supplied with standard hardware, 1/4" stainless steel 316.

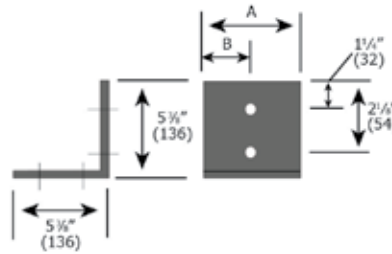

Horizontal 90° splice plates

Cat. No.	Material
NM-XSS-1901H-SS6	Stainless steel
NM-XFP-1901H-SS6	Polyester resin
NM-XFV-1901H-SS6	Vinylester resin

Supplied in pairs. Supplied with standard hardware, 1/4" stainless steel 316.

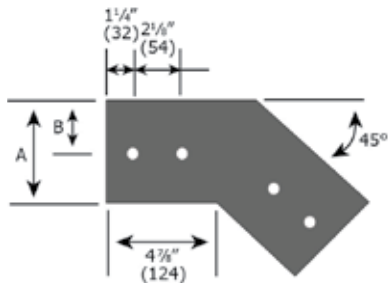

Horizontal 45° splice plates

Cat. No.	Material
NM-XSS-1451H-SS6	Stainless steel
NM-XFP-1451H-SS6	Polyester resin
NM-XFV-1451H-SS6	Vinylester resin

Supplied in pairs. Supplied with standard hardware, 1/4" stainless steel 316.

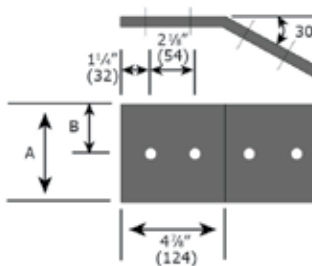

Horizontal 30° splice plates

Cat. No.	Material
NM-XSS-1301H-SS6	Stainless steel
NM-XFP-1301H-SS6	Polyester resin
NM-XFV-1301H-SS6	Vinylester resin

Supplied in pairs. Supplied with standard hardware, 1/4" stainless steel 316.

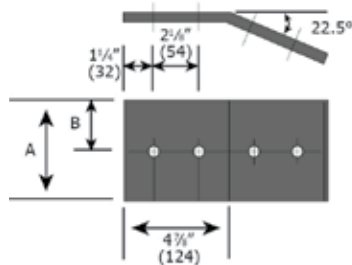

Horizontal 22.5° splice plates

Cat. No.	Material
NM-XSS-1221H-SS6	Stainless steel
NM-XFP-1221H-SS6	Polyester resin
NM-XFV-1221H-SS6	Vinylester resin

Supplied in pairs. Supplied with standard hardware, 1/4" stainless steel 316.

Nonmetallic - Channel tray systems

Expansion and vertical 90°, 45°, 30° & 22.5° splice plates

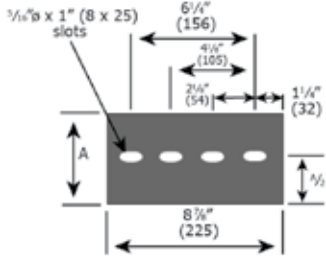

Expansion splice plates

Cat. No.	Material
NM-XSS-1011-SS6	Stainless steel
NM-XFP-1011-SS6	Polyester resin
NM-XFV-1011-SS6	Vinylester resin

Supplied in pairs. Supplied with standard hardware, 1/4" stainless steel 316.

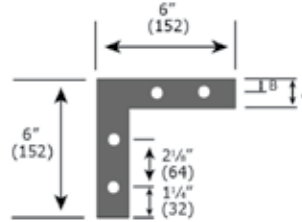

Vertical 90° splice plates

Cat. No.	Material
NM-XSS-1901V-SS6	Stainless steel
NM-XFP-1901V-SS6	Polyester resin
NM-XFV-1901V-SS6	Vinylester resin

Supplied in pairs. Supplied with standard hardware, 1/4" stainless steel 316.

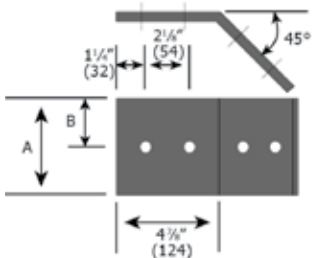

Vertical 45° splice plates

Cat. No.	Material
NM-XSS-1451V-SS6	Stainless steel
NM-XFP-1451V-SS6	Polyester resin
NM-XFV-1451V-SS6	Vinylester resin

Supplied in pairs. Supplied with standard hardware, 1/4" stainless steel 316.

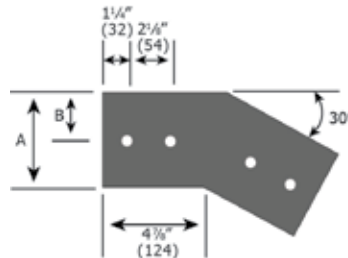

Vertical 30° splice plates

Cat. No.	Material
NM-XSS-1301V-SS6	Stainless steel
NM-XFP-1301V-SS6	Polyester resin
NM-XFV-1301V-SS6	Vinylester resin

Supplied in pairs. Supplied with standard hardware, 1/4" stainless steel 316.

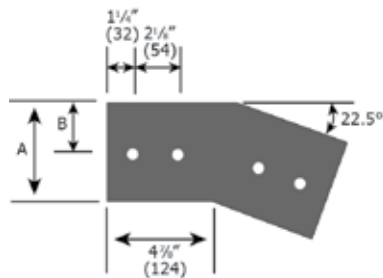

Vertical 22.5° splice plates

Cat. No.	Material
NM-XSS-1221V-SS6	Stainless steel
NM-XFP-1221V-SS6	Polyester resin
NM-XFV-1221V-SS6	Vinylester resin

Supplied in pairs. Supplied with standard hardware, 1/4" stainless steel 316.

Nonmetallic - Strut systems

Channels

Channels

ABB is proud of its line of nonmetallic strut and accessories. You'll find a complete selection of nonmetallic accessories, fasteners, hangers, pipe clamps and channels.

Most ABB strut products are available in a choice of resins – either vinylester or polyester. Our design and engineering staff is ready to help you select the material that best suits your needs.

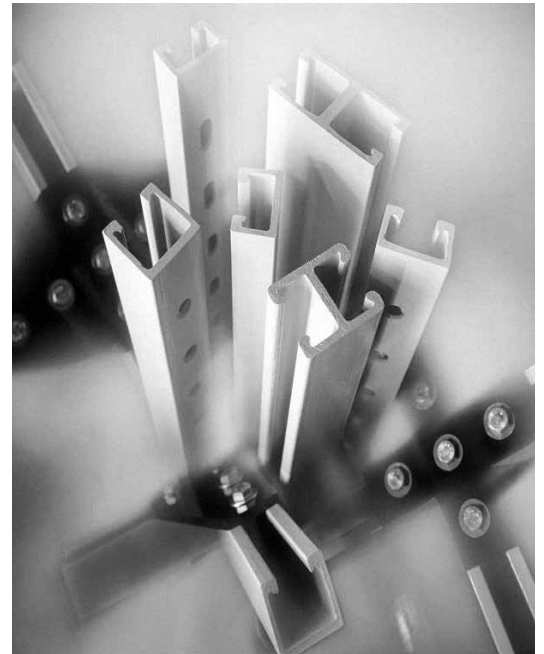

Channel fitting selection

Example:

NM-SSP-100-120, 1" (25.5mm) single strut, 120" (10 ft. / 3.05m) NOTE: Stocked in 120" (10 ft. / 3.05m) and 240" (20 ft. / 6.10m) lengths.

*NOTE: The U-style and H-style systems are interchangeable.

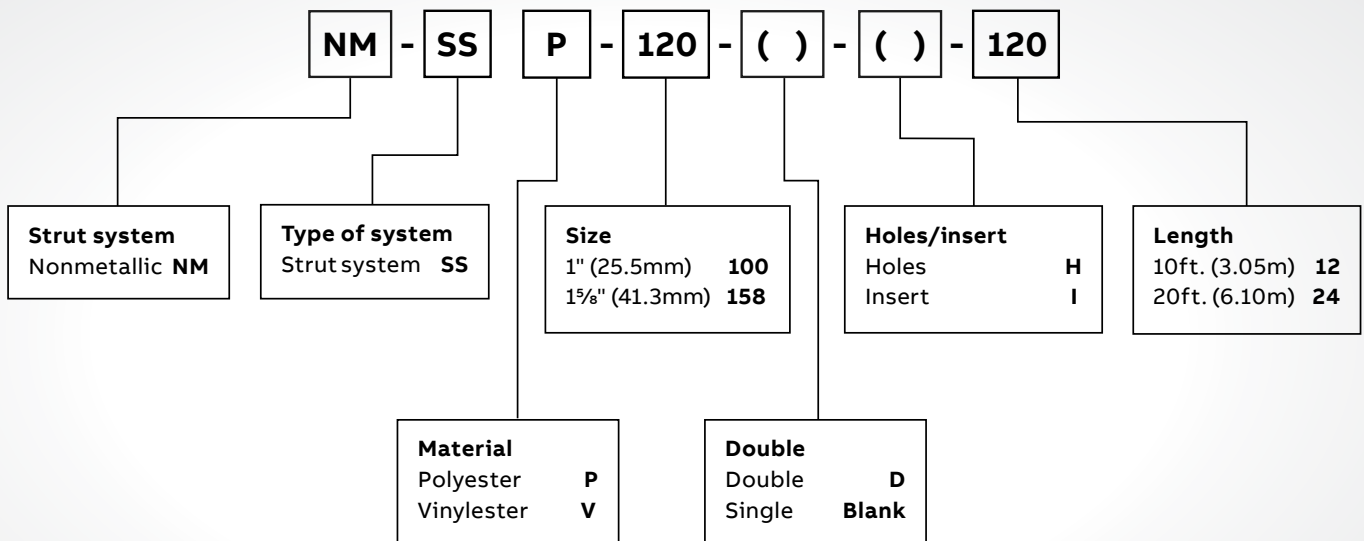

Nonmetallic - Strut systems

Channels - Combinations and hole pattern

Solid - Single strut

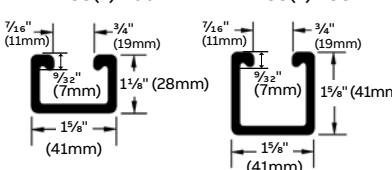
					Weight	
		Cat. No.	Material/resin	Color	(lb./ft.)	(kg/m)
	NM-SS(*)-100	NM-SSP-100-(L)	Polyester	Gray	0.47	0.70
	NM-SS(*)-158	NM-SSP-158-(L)	Polyester	Gray	0.63	0.94
		NM-SSV-100-(L)	Vinylester	Beige	0.47	0.70
		NM-SSV-158-(L)	Vinylester	Beige	0.63	0.94

*Add P for polyester or V for vinylester.
 (L) Add desired length 120 (10 ft.) or 240 (20 ft.)
 Cut-to-length channel also available.

Solid - Back to back

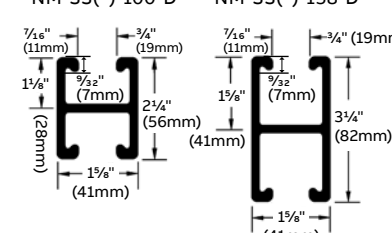
					Weight	
		Cat. No.	Material/resin	Color	(lb./ft.)	(kg/m)
	NM-SS(*)-100-D	NM-SSP-100-D-(L)	Polyester	Gray	0.86	1.28
	NM-SS(*)-158-D	NM-SSP-158-D-(L)	Polyester	Gray	1.17	1.75
		NM-SSV-100-D-(L)	Vinylester	Beige	0.86	1.28
		NM-SSV-158-D-(L)	Vinylester	Beige	1.17	1.75

*Add P for polyester or V for vinylester.
 (L) Add desired length 120 (10 ft.) or 240 (20 ft.)
 Cut-to-length channel also available.

Punched

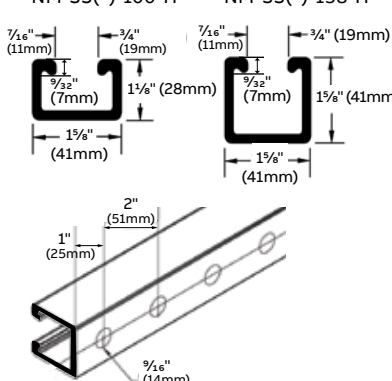
					Weight	
		Cat. No.	Material/resin	Color	(lb./ft.)	(kg/m)
	NM-SS(*)-100-H	NM-SSP-100-H-(L)	Polyester	Gray	0.47	0.67
	NM-SS(*)-158-H	NM-SSP-158-H-(L)	Polyester	Gray	0.63	0.91
		NM-SSV-100-H-(L)	Vinylester	Beige	0.45	0.67
		NM-SSV-158-H-(L)	Vinylester	Beige	0.61	0.91

*Add P for polyester or V for vinylester.
 (L) Add desired length 120 (10 ft.) or 240 (20 ft.)
 Cut-to-length channel also available.

Nonmetallic - Strut systems

Superstrut™ fittings and brackets

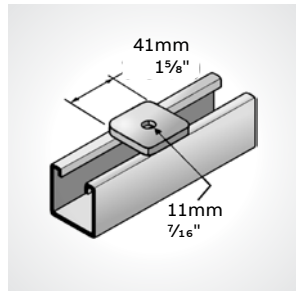

01

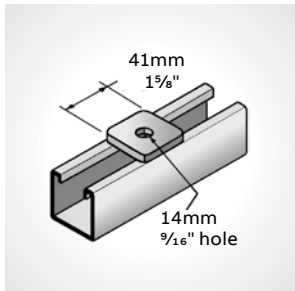

02

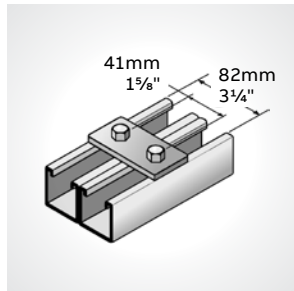

03

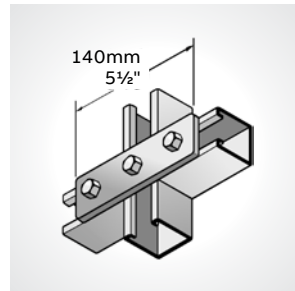

04

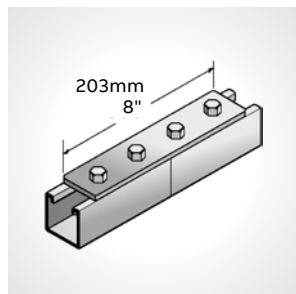

05

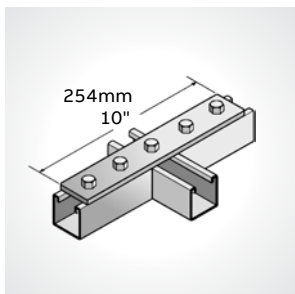

06

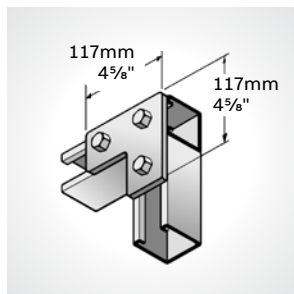

07

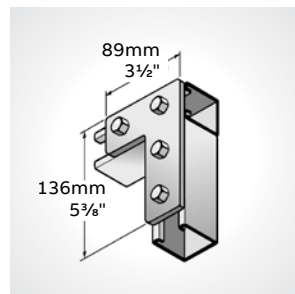

08

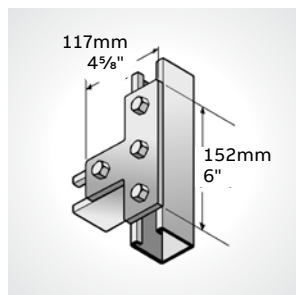

09

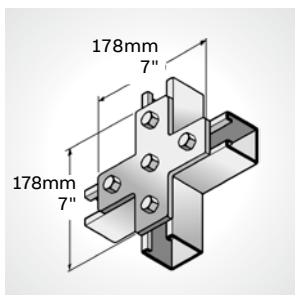

10

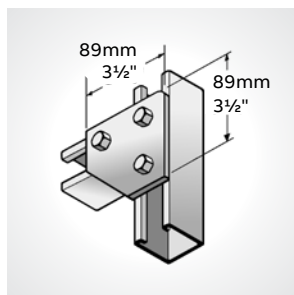

11

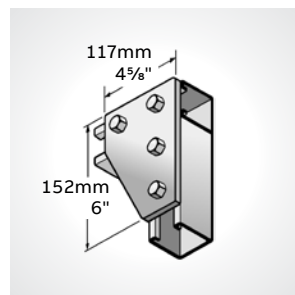

12

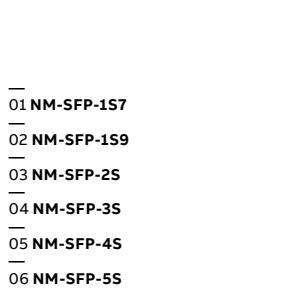

13

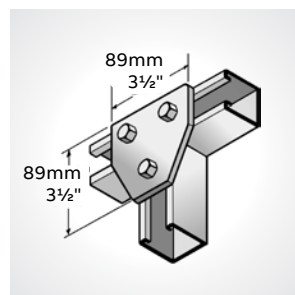

14

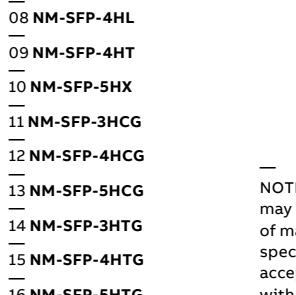

15

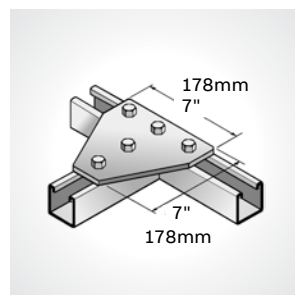

16

- 01 NM-SFP-1S7
- 02 NM-SFP-1S9
- 03 NM-SFP-2S
- 04 NM-SFP-3S
- 05 NM-SFP-4S
- 06 NM-SFP-5S
- 07 NM-SFP-3HL
- 08 NM-SFP-4HL
- 09 NM-SFP-4HT
- 10 NM-SFP-5HX
- 11 NM-SFP-3HCG
- 12 NM-SFP-4HCG
- 13 NM-SFP-5HCG
- 14 NM-SFP-3HTG
- 15 NM-SFP-4HTG
- 16 NM-SFP-5HTG

NOTE: Based on individual applications, changes may be required on dimension and thickness of material. All fittings are 3/4" (6mm) thick unless specified otherwise. All holes are drilled to accept 3/8" and 1/2" bolts with washers. Not supplied with hardware.

Nonmetallic - Strut systems

Superstrut fittings and brackets

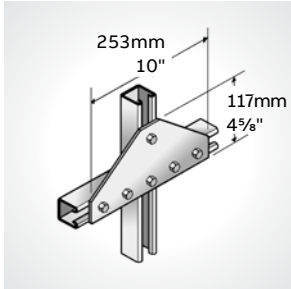

01*

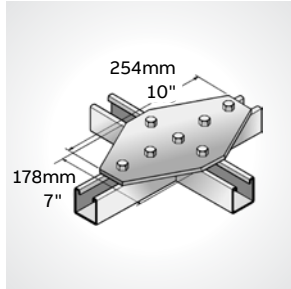

02*

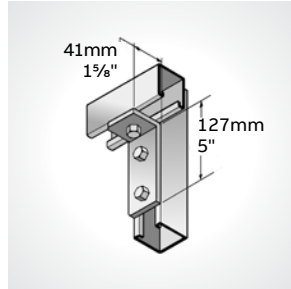

03*

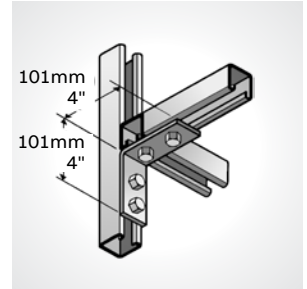

04*

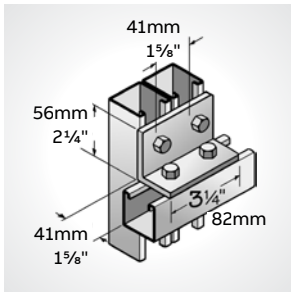

05*

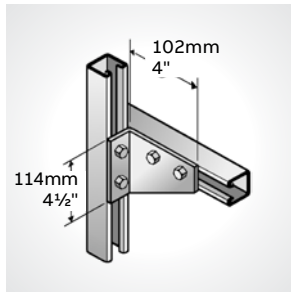

06*

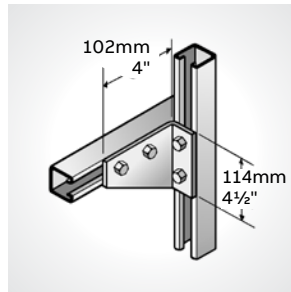

07*

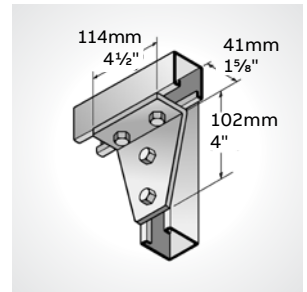

08*

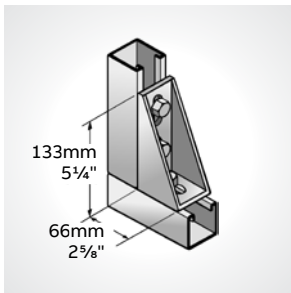

09

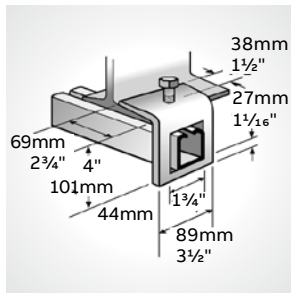

10

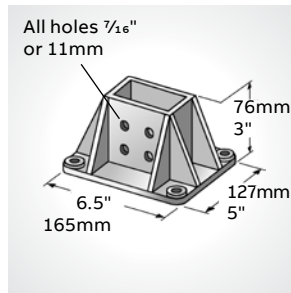

11

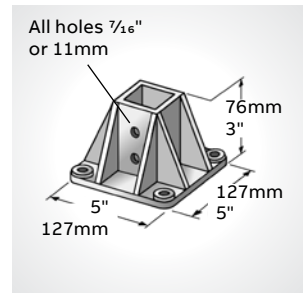

12

01 NM-SFP-6HTG

02 NM-SFP-7HXG

03 NM-SFP-3VL

04 NM-SFP-4VL

05 NM-SFP-4VLD

06 NM-SFP-4VGL

07 NM-SFP-4VGR

08 NM-SFP-4VTG

09 NM-SFP-3CB

10 NM-SWC-158

11 NM-SSV-DBASE

12 NM-SSV-SBASE

* Items 2 thru 8 (FRP angle components) will not support tensile loads or forces.

NOTE: Based on individual applications, changes may be required on dimension and thickness of material. All fittings are 1/4" (6mm) thick unless specified otherwise. All holes are drilled to accept 3/8" and 1/2" bolts with washers. Not supplied with hardware.

Nonmetallic - Strut systems

Nonmetallic threaded hardware

Hex head bolt

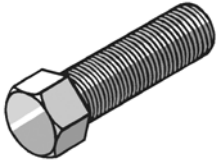

Cat. No.	Thread size	Bolt length (in.)	Design load		Max. torque		Weight / C	
			(lb)	N	in - lb	N - m	(lb)	(g)
NM-F516100	5/16" - 18	5/16 x 1	190	845	30	3.4	0.4	181
NM-F516114	5/16" - 18	5/16 x 1 1/4	190	845	30	3.4	0.4	181
NM-F38100	3/8" - 16	3/8 x 1	300	1,334	45	5.1	0.9	408
NM-F38114	3/8" - 16	3/8 x 1 1/4	300	1,334	45	5.1	1.1	499
NM-F38212	3/8" - 16	3/8 x 2 1/2	300	1,334	45	5.1	1.5	680
NM-F12100	1/2" - 13	1/2 x 1	490	2,180	110	12.4	1.4	635
NM-F12114	1/2" - 13	1/2 x 1 1/4	490	2,180	110	12.4	1.8	816
NM-F12212	1/2" - 13	1/2 x 2 1/2	490	2,180	110	12.4	3.7	1,678

Safety factor of 3 on design load.

Hex nut

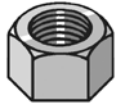

Cat. No.	Thread size	(in.)	Height		Weight / C	
			(mm)	(lb)	(g)	
NM-F38HN	3/8" - 16	2 1/64	8	0.69	136	
NM-F12HN	1/2" - 13	7/16	11	0.69	318	
NM-F58HN	5/8" - 11	3 5/64	14	0.69	635	

NOTE: 3/4" and 1" sizes are available.

Standard lengths are 4 ft. and 8 ft. Example: NM-F38HN-4.

All-thread rod

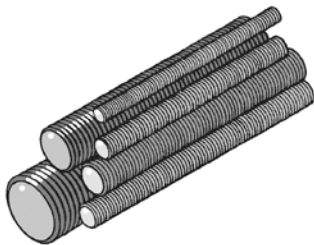

Cat. No.	Thread size	Design load		Max. torque		Weight / C	
		(lb)	N	in - lb	N - m	(lb)	(g)
NM-F38AT	3/8" - 16	425	1,890	45	5.1	0.08	36
NM-F12AT	1/2" - 13	750	3,336	110	12.4	0.13	59
NM-F58AT	5/8" - 11	950	4,226	230	26	0.21	95

Safety factor of 3 on design load. NOTE: 3/4" and 1" sizes are available.

Nonmetallic - Strut systems

Nonmetallic threaded hardware

All-thread rod hex nut

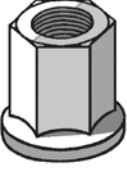
	Cat. No.	Thread size	Height		Weight / C	
			(in.)	(mm)	(lb)	(g)
	NM-F38ATHN	3/8" - 16	3/4	19	0.8	376
	NM-F12ATHN	1/2" - 13	7/8	22	1.7	771

Rod coupler

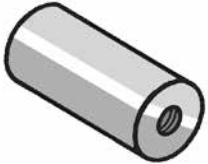
	Cat. No.	Thread size	Weight / C	
			(lb)	(kg)
	NM-FRC38	3/8" - 16	7.4	3.36
	NM-FRC12	1/2" - 13	11.3	5.13
	NM-FRC58	5/8" - 11	16.7	7.57

3/4" and 1" sizes are available.

Nonmetallic - Strut systems

Nonmetallic pipe hangers, brackets and beam clamps

Clevis hangers

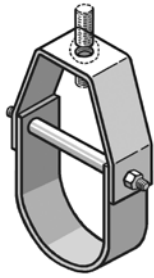

Cat. No.	Nominal pipe size		Max. O.D. range		Hanger rod size	Design load	
	(in.)	(mm)	(in.)	(mm)		(lb)	N
NM-SCH200	2	50.8	2½	63.5	½ - 13	90	0.40
NM-SCH212	2½	63.5	¾	82.6	½ - 13	120	0.54
NM-SCH300	3	76.2	¾	98.4	½ - 13	160	0.71
NM-SCH400	4	101.6	5	127	⅝ - 11	250	1.12
NM-SCH600	6	152.4	7	177.8	⅝ - 11	400	1.79
NM-SCH800	8	203.2	9	228.6	⅝ - 11	450	2.01
NM-SCH1000	10	250	11¾	288.9	⅝ - 11	500	2.24
NM-SCH1200	12	304.8	13½	342.9	⅝ - 11	600	2.69

Safety factor of 3 on design loads at 120°F (49°C). Insulation may be required at high temperatures. Order hanger rods and nuts separately.

Support brackets

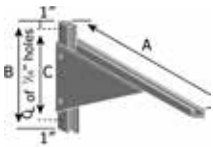

Cat. No.*	Dimension "A"		Dimension "B"		Dimension "C"		Design load	
	(in.)	(mm)	(in.)	(mm)	(in.)	(mm)	(lb)	N
SB 1								
NM-SB1-6P	10	254	12	304.8	10	254	1,600	7,117
NM-SB1-9P	13	330.2	12	304.8	10	254	1,100	4,893
NM-SB1-12P	16	406.4	12	304.8	10	254	850	3,781
NM-SB1-18P	22	558.8	12	304.8	10	254	725	3,225
NM-SB1-24P	28	711.2	12	304.8	10	254	480	2,135
NM-SB2-24P	26	660.4	21	533.4	15	381	750	3,336
NM-SB2-30P	32	812.8	21	533.4	15	381	750	3,336
NM-SB2-36P	38	965.2	21	533.4	15	381	750	3,336

*Substitute "V" for "P" when vinyl ester resin is needed. Design loads based on uniform. Allowable load is based on a total load, uniformly distributed over the length of the rack. Safety factor = 2.0 loading with a safety factor of 3.

Beam clamps

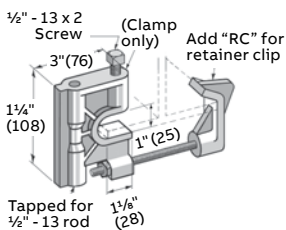

Cat. No.	Description	Design load	
		(lb./ft.)	(kg/m)
NM-SBC	Beam clamp	800	3.56
NM-SBC-RC	Beam clamp with retainer clip	800	3.56

Safety factor of 3 on design load.

Nonmetallic - Strut systems

Nonmetallic pipe hangers and hardware

U-bolt

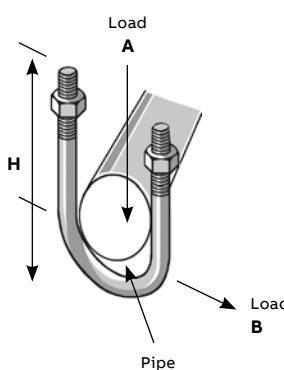

Cat. No.	Nominal pipe size		H	Design load A		Design load B		Max. torque		Weight / C	
	(in.)	(mm)	(in.)	(lb)	N	(lb)	N	in - lb	N - m	(lb)	(kg)
NM-FUB050	½	12.7	2.41	300	1,334	150	667	30	3.4	3.5	1.59
NM-FUB075	¾	19.1	2.60	300	1,334	150	667	30	3.4	3.9	1.77
NM-FUB100	1	25.4	2.85	300	1,334	150	667	30	3.4	4.4	2.00
NM-FUB114	1¼	31.8	3.16	300	1,334	150	667	30	3.4	4.8	2.18
NM-FUB112	1 ½	38.1	3.47	300	1,334	150	667	30	3.4	5.2	2.36
NM-FUB200	2	50.8	4.18	600	2,669	200	890	60	6.8	7.7	3.49
NM-FUB212	2½	63.5	4.68	600	2,669	200	890	60	6.8	10.2	4.63
NM-FUB300	3	76.2	5.31	600	2,669	200	890	60	6.8	12.6	5.72
NM-FUB312	3½	88.9	5.81	600	2,669	200	890	60	6.8	15.1	6.85
NM-FUB400	4	101.6	6.31	600	2,669	200	890	60	6.8	17.6	7.98

Safety factor of 3 on design load.

Channel nut



Part. No.	Thread size	Weight / C		Dimension "t"	
		(lb)	(g)	(in.)	(mm)
NM-FCN14	¼-20	5.58	2,531	1½/16	27
NM-FCN38	¾-16	5.31	2,408	1½/16	27
NM-FCN12	½-13	5.27	2,390	1½/16	27

Vinyl Ester resin is the standard. Channel nuts are self locking and designed for use with strut only. Resistance to slip = 450 Lbs. per bolt Pull out strength = 700 lb per bolt . Safety factor of 3 on design load.

Flat washer



Cat. No.	Hole size (in.)	Weight / C	
		(lb)	(g)
NM-F38W	¾	0.5	227
NM-F12W	½	0.5	227
NM-F58W	⅝	0.5	227
NM-F34W	¾	0.5	227
NM-F100W	1	0.5	227

Nonmetallic - Strut systems

Sealant



Kit contents

- Resin
- Catalyst
- Stir stick and applicator

Brush-on resin seal kit

Cat. No.	Description
NM-RSK-QT	946 ml

To reseal fiberglass after field modifications.
Vinylester resin.

Nonmetallic - Strut systems

Pipe clamps

Rigid pipe clamp*

Cat. No.	Nominal pipe size		Design load		Max. Torque		
	(in.)	(mm)	(lb)	(kg)	N	(in. - lb)	(N - m)
NM-SRPC050	½	12.7	300	136	1.33	10	1.13
NM-SRPC075	¾	19.1	300	136	1.33	10	1.13
NM-SRPC100	1	25.4	300	136	1.33	10	1.13
NM-SRPC114	1¼	31.8	300	136	1.33	10	1.13
NM-SRPC112	1½	38.1	300	136	1.33	10	1.13
NM-SRPC200	2	50.8	300	136	1.33	10	1.13
NM-SRPC212	2½	63.5	300	136	1.33	10	1.13
NM-SRPC300	3	76.2	300	136	1.33	10	1.13
NM-SRPC312	3½	88.9	300	136	1.33	10	1.13
NM-SRPC400	4	101.6	300	136	1.33	10	1.13

Safety factor of 3 on design load.
*Fastener is included

Conduit swivel clamp

Cat. No.	Description
NM-SCSC-(CTD)	Conduit swivel clamp

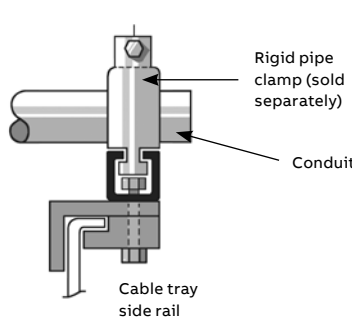

Cable tray designation (CTD) required. (Ex. 6CP series designates 6" deep polyester resin). Pipe clamps are a separate order item.

Nonmetallic - Strut systems

Channel Loading Chart

Loading information

Beam loads: The charts below list the total allowable uniform load for various simple spans based on a minimum safety factor of 2.

If the load is concentrated at center span, multiply the load by 0.5 and the corresponding deflection by 0.8.

Channel framing loading – Beam and column data: Polyester and vinyl ester resin base

Beam span in. / (mm)	Cat. No.	Maximum allowable uniform beam load		Deflection @ Maximum allowable uniform beam load		Uniform load @ Maximum deflection = 0.25 in. (6mm)		Uniform load @ Maximum Deflection = 0.50 in. (13mm)		Maximum allowable column load lb (kg)
		Poly lb (kg)	Vinyl lb (kg)	Poly lb (kg)	Vinyl (kg)	Poly lb (kg)	Vinyl lb (kg)	Poly lb (kg)	Vinyl lb (kg)	
12 (304.8)	NM-SSP-100	790 (358)	990 (449)	0.11 (3)	0.12 (3)	-	-	-	-	2,550 (1,156)
	NM-SSP-158	1,720 (780)	2,150 (975)	0.07 (2)	0.07 (2)	-	-	-	-	3,650 (1,655)
	NM-SSP-158-D	5,080 (2,301)	6,350 (2,880)	0.04 (1)	0.04 (1)	-	-	-	-	7,300 (3,111)
18 (457)	NM-SSP-100	530 (240)	670 (304)	0.24 (6)	0.27 (7)	-	620 (281)	-	-	2,350 (1,066)
	NM-SSP-158	1,150 (521)	1,440 (653)	0.15 (4)	0.17 (4)	-	-	-	-	3,370 (1,528)
	NM-SSP-158-D	5,080 (2,301)	4,240 (1,923)	0.09 (2)	0.10 (2)	-	-	-	-	6,740 (3,058)
24 (609.6)	NM-SSP-100	400 (181)	500 (227)	0.43 (11)	0.48 (12)	240 (109)	270 (122)	-	-	2,070 (939)
	NM-SSP-158	860 (390)	1,080 (490)	0.27 (7)	0.30 (8)	810 (367)	910 (412)	-	-	2,960 (1,342)
	NM-SSP-158-D	2,540 (1,152)	3,180 (1,442)	0.16 (4)	0.17 (4)	-	-	-	-	5,920 (2,685)
30 (762)	NM-SSP-100	320 (145)	400 (181)	0.67 (17)	0.75 (19)	120 (54)	140 (63)	240 (109)	270 (122)	1,710 (775)
	NM-SSP-158	690 (313)	870 (394)	0.42 (11)	0.48 (12)	410 (186)	460 (209)	-	-	2,450 (1,111)
	NM-SSP-158-D	2,040 (925)	2,550 (1,156)	0.24 (6)	0.27 (7)	2,000 (907)	2,350 (1,066)	-	-	4,900 (2,222)
36 (914.4)	NM-SSP-100	270 (122)	340 (154)	0.98 (25)	1.10 (28)	70 (31)	80 (36)	140 (63)	160 (72)	1,260 (571)
	NM-SSP-158	580 (263)	730 (331)	0.61 (15)	0.69 (19)	240 (109)	270 (122)	480 (217)	540 (245)	1,800 (816)
	NM-SSP-158-D	1,700 (771)	2,130 (966)	0.35 (9)	0.39 (10)	1,220 (553)	1,370 (621)	-	-	3,600 (1,633)
42 (1066.8)	NM-SSP-100	230 (104)	290 (131)	1.32 (34)	1.49 (38)	50 (22)	55 (25)	100 (45)	115 (52)	920 (417)
	NM-SSP-158	490 (222)	620 (281)	0.82 (21)	0.92 (23)	150 (68)	170 (77)	300 (136)	340 (154)	1,320 (598)
	NM-SSP-158-D	1,460 (662)	1,830 (830)	0.48 (12)	0.62 (16)	770 (349)	870 (394)	1,510 (650)	1,720 (530)	2,640 (1,197)
48 (1219.2)	NM-SSP-100	200 (91)	250 (113)	1.72 (44)	1.92 (49)	30 (13)	25 (16)	60 (27)	70 (31)	700 (317)
	NM-SSP-158	430 (195)	540 (245)	1.07 (27)	1.20 (30)	100 (45)	115 (52)	200 (90)	230 (104)	1,010 (458)
	NM-SSP-158-D	1,270 (576)	1,590 (721)	0.62 (16)	0.69 (17)	520 (236)	590 (267)	1,040 (471)	1,170 (780)	2,020 (916)
60 (1524)	NM-SSP-100	160 (72)	200 (91)	2.68 (68)	2.99 (76)	20 (9)	23 (10)	40 (18)	45 (20)	180 (81)
	NM-SSP-158	350 (158)	400 (200)	1.70 (43)	1.91 (48)	60 (27)	70 (32)	120 (54)	135 (61)	260 (118)
	NM-SSP-158-D	1,020 (462)	1,280 (580)	0.97 (25)	1.09 (28)	270 (122)	310 (140)	540 (245)	610 (276)	520 (235)
72 (1828.8)	NM-SSP-100	140 (63)	180 (81)	-	-	10 (4)	12 (5)	20 (9)	23 (10)	-
	NM-SSP-158	290 (131)	370 (168)	2.44 (62)	2.78 (71)	30 (13)	34 (15)	60 (27)	70 (32)	-
	NM-SSP-158-D	850 (385)	1,070 (485)	1.40 (35)	1.57 (40)	160 (72)	180 (81)	320 (145)	360 (163)	-
84 (2133.6)	NM-SSP-100	120 (54)	150 (68)	-	-	NR	-	12 (5)	15 (7)	-
	NM-SSP-158	250 (113)	320 (145)	-	-	20 (9)	23 (10)	40 (18)	45 (20)	-
	NM-SSP-158-D	730 (331)	920 (417)	1.91 (48)	2.15 (55)	100 (45)	115 (52)	200 (90)	230 (104)	-
96 (2438.4)	NM-SSP-100	100 (45)	130 (59)	-	-	NR	-	-	-	-
	NM-SSP-158	220 (100)	250 (113)	-	-	13 (6)	15 (7)	26 (12)	30 (13)	-
	NM-SSP-158-D	640 (290)	800 (363)	2.50 (63)	2.79 (71)	70 (32)	80 (36)	140 (63)	160 (72)	-

Temperature	Design load multiplier
75°F (24°C)	100%
100°F (38°C)	90%
125°F (52°C)	78%
150°F (66°C)	68%
175°F (79°C)	60%
200°F (93°C)	52%

Recommended guideline

Published design loads are based on usage at 70°F (21°C) and must be reduced for continuous exposure to higher temperatures. Refer to the chart opposite for high temperature applications.