

B

**Red Dot®/Carlson®/Iberville® -
Weatherproof boxes, covers, accessories
and FS/FD dry location boxes and covers**



—

B

Red Dot/Carlton/Iberville -
Weatherproof boxes, covers, accessories
and FS/FD dry location boxes and covers

Table of contents

Section B

Overview	B4
Red Dot Weatherproof metallic covers	B5
Red Dot Weatherproof nonmetallic covers	B9
Red Dot Weatherproof kits	B11
Red Dot Weatherproof metallic boxes	B13
Red Dot Flip-lid Weatherproof metallic covers	B18
Carlton Weatherproof nonmetallic boxes	B23
Carlton Weatherproof nonmetallic covers	B26
Iberville and Red Dot Weatherproof metallic boxes	B29
Red Dot Weatherproof metallic lampholders	B31
Iberville Weatherproof products	B36
Red Dot Weatherproof products	B42
Carlton Weatherproof fittings	B45
Dry location boxes	B46
Dry location covers	B47
Cross reference	B49

Overview

Weatherproof boxes, covers and lighting products

The industry's preferred choice for more than 50 years – Red Dot weatherproof boxes and covers withstand the harshest elements and ensure trouble-free installation and performance.



Boxes

Red Dot boxes are made from durable die-cast aluminum and available in single- and double-gang rectangular as well as round configurations – with a variety of hub sizes to meet all needs.



Lighting

Red Dot has a complete lighting package for general purpose outdoor lighting as well as vaportight lighting.



While-in-use

Red Dot offers a wide variety of both metallic and nonmetallic while-in-use covers. All of these covers help ensure that you meet the requirements of the Canadian Electrical Code.



Merchandisers

With your choice of various stock displays or a customized display to fit your needs, Red Dot makes it easy to increase your counter sales.



Covers

Red Dot die-cast flip-lid weatherproof covers protect any outdoor receptacle from the elements. Constructed from rugged die-cast zinc, these covers will last a lifetime. A full line of nonmetallic covers is also available.

Red Dot Weatherproof metallic covers

Wet or dry, all outlets can go undercover with Code Keeper™

Code Keeper

Code Keeper while-in-use applications

Weatherproof covers are required by the Canadian Electrical Code anyplace where water may come in contact with electrical outlets when a plug is in use. Code Keeper covers are also ideal anywhere to prevent accidental disconnects, reduce tampering and to provide a lockable cover that meets OSHA requirements.

Suggested applications:

- 1 Residential – holiday and landscape lighting, wells and sump pumps, sprinkler systems, plug-in timers, garages, patios.
- 2 Commercial – vending machines, car washes, outdoor signs, restaurant kitchens, greenhouses and nurseries, marinas, garages, lumberyards.
- 3 Industrial – manufacturing areas, food processing, water treatment plants, security cameras, laboratories, loading docks.
- 4 Recreational – pools and spas, parks, playgrounds, zoos, RV connections, athletic fields, ball parks, stadiums, outdoor stages, amphitheaters, golf courses.

Canadian Electrical Code, Rule 26-708

- 2) Receptacles of CSA configurations 5-15R, 5-20R, 5-20RA, 6-15R, 6-20R, and 6-20RA shall be provided with cover plates suitable for wet locations, whether or not a plug is inserted into the receptacle and marked “Extra Duty.”
- 3) Not with standing Subrules 1) and 2), cover plates marked “Wet Location Only When Cover Closed,” or the equivalent, shall be permitted for receptacles:
 - a) installed facing downward at an angle of 45° or less from the horizontal; or
 - b) located at least 1 m above finished grade or floor level and not in a wet location.

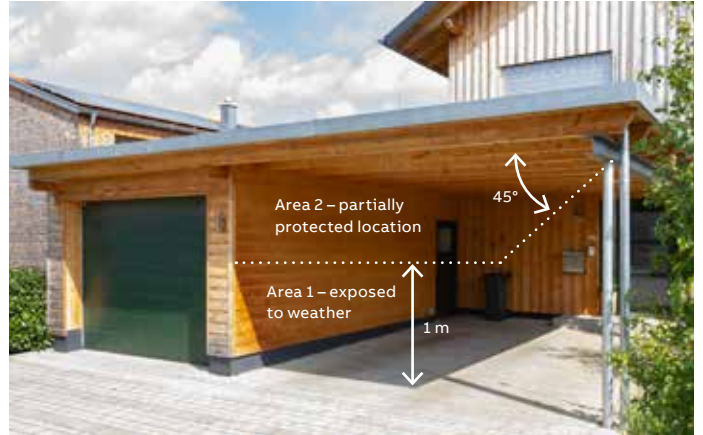

Code Keeper while-in-use covers are suitable for installation in Area 1 – exposed to weather.



Red Dot Code Keeper wet location cover is NEMA 3R rated, UL listed and CSA certified and meets all the requirements of CEC Rule 26-708 (2) (3). Code Keeper covers are rugged, corrosion-resistant metal or plastic construction that provide long-lasting durability and are not subject to cracking or breaking. Made with the same Red Dot quality that contractors know and trust. Code Keeper covers offer a lifetime of use and safety.

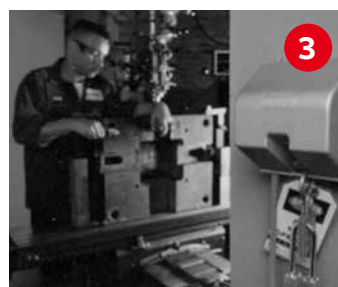

Red Dot Weatherproof metallic covers

Code Keeper metallic while-in-use covers

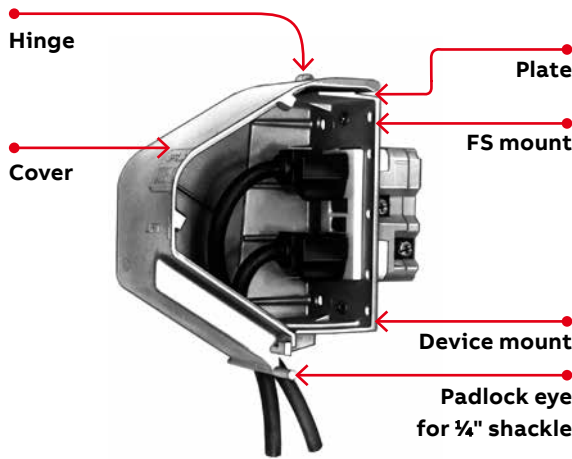

Features/Benefits:

- Copper-free* aluminum alloy provides increased corrosion resistance
- Die-cast, metal construction provides long-lasting durability
- NEMA 3R rating ensures protection against falling rain, sleet and external ice formation when used with appropriate device boxes
- Clear UL and CSA markings speed approval by inspectors
- Wide range of cover depths and receptacle configurations accommodate almost every common plug and cord size when combined with included adapter plates
- Combination box or device mounting design provides flexibility in installation
- Lockable for security, whether in use or not
- "Extra-Duty" per CEC Rule 26-708(2)
*Less than 0.004% copper content.

Applications:

- Protects receptacles, switches and plugs for single-gang and two-gang configurations in dry and wet locations
- Prevents accidental equipment disconnects, reduces tampering and deters theft and equipment removal
- Required by CEC Rule 26-708(2)(3), anywhere a receptacle of CSA configuration 5-15R, 5-20R, 5-20RA, 6-15R, 6-20R or 6-20RA is exposed to the weather (Area 1). See illustration on page B3.

Standard materials:

- Covers and plates: Die-cast aluminum alloy with less than 0.004% copper content (copper-free)
- Gaskets: Closed-cell foam

Standard finish:

- Powder-coated finish

Compliances:

- CEC Rule 26-702(2)(3)
- UL listed
- CSA certified



CKSUV



CKMU



CKMUV



2CKU

Red Dot Weatherproof metallic covers

Code Keeper metallic while-in-use covers – Single gang

“Extra-Duty” per CEC Rule 26-708(2)



CKSUV – Small vertical cover, 2¼" internal depth



Cat. no.	Colour	Std. ctn.
CKSUV	Grey	8

Diagrams

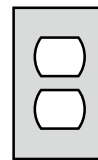

Duplex

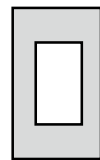

GFCI

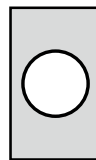

Single receptacle up to 1½"

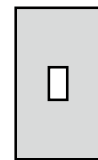

Switch

Use for any of these configurations

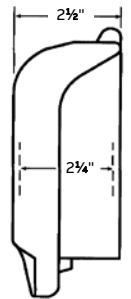

Note: Covers packed with gasket and screws.



CKMU – Medium horizontal cover, 3¼" internal depth



Cat. no.	Colour	Std. ctn.
CKMU	Grey	3

Diagrams

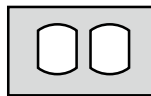

Duplex

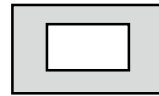

GFCI

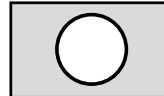

Single receptacle up to 1½"

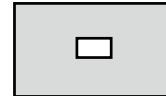

Switch

Use for any of these configurations

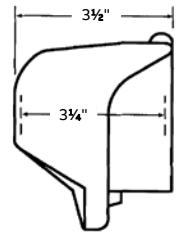

Note: Covers packed with gasket and screws.



CKMUV – Medium vertical cover, 3¼" internal depth



Cat. no.	Colour	Std. ctn.
CKMUV	Grey	6

Diagrams

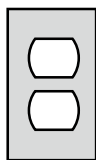

Duplex

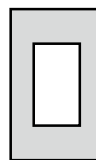

GFCI

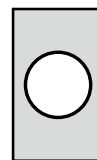

Single receptacle up to 1½"

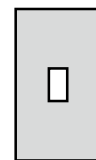

Switch

Use for any of these configurations

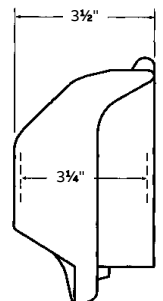

Note: Covers packed with gasket and screws.

Red Dot metallic covers

Code Keeper metallic while-in-use covers – Two-gang



2CKU – Regular cover, 4 1/4" internal depth



Cat. no.	Colour	Std. ctn.
2CKU	Grey	2

Diagrams

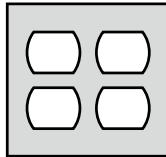

Two-duplex receptacle cover

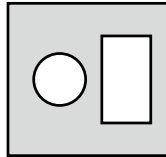

Single up to 1 1/2" and GFCI receptacle cover

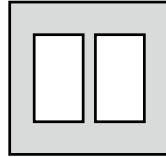

Two-GFCI receptacle cover

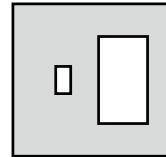

Toggle and GFCI receptacle cover

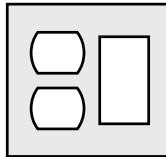
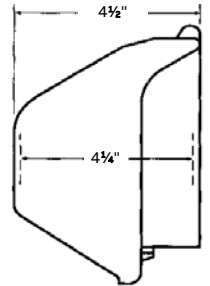

Duplex and GFCI receptacle cover

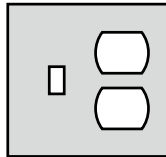

Toggle and duplex receptacle cover

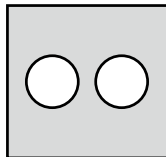

Two-single up to 1 1/2" receptacle cover

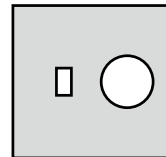

Toggle and single up to 1 1/2" receptacle cover

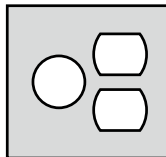

Single up to 1 1/2" and duplex receptacle cover

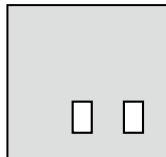

Two-toggle switch cover

Use for any of these configurations:

Note: Covers packed with gasket and screws.

Red Dot Weatherproof nonmetallic covers

Code Keeper extra-duty nonmetallic weatherproof while-in-use covers



CKPM-C-CN



2CKPM-C-CN

One cover handles GFCI, single, duplex or switch configurations

Red Dot Code Keeper extra-duty nonmetallic weatherproof while-in-use covers make it easier than ever to comply with Canadian Electrical Code (CEC) requirements for receptacles in wet locations. Weatherproof covers are often subject to bumps and impact through everyday use, but this reinforced design withstands abuse, featuring a stainless steel hinge pin for rugged cover attachment that's great for high-traffic areas.

Pre-configured for GFCI, each cover ships with adapter plates to accommodate single or duplex receptacles and switches. Now, contractors can handle any application they encounter without needing dozens of different covers.

- Complies with CEC Rule 26-708(2) for extra-duty outlet box hoods – required in wet locations (area 1)
- Robust stainless steel hinge pin – ideal for high-traffic areas
- Available in single- and two-gang configurations with a variety of cover depths
- Accommodates numerous receptacle configurations and almost every common plug and cord size
- Keyhole mounts make it fast and easy to install – just loosen existing device screws and slide cover over
- Combination box or device-mounting design provides flexibility in installation
- Lockable for security, whether in use or not
- Ships with adapter plates and pre-mounted gaskets
- Unique wasp guard included to keep out unwanted pests

Red Dot Code Keeper extra-duty nonmetallic while-in-use covers



Cat. no	Top colour	Bottom colour	Std. ctn.
Single-gang shallow – vertical or horizontal – 2¼" deep			
CKPS-C-CN	Clear	Grey	7
CKPS-G-CN	Grey	Grey	7
CKPS-W-CN	White	White	7
CKPS-BR-CN	Bronze	Bronze	7
Single-gang medium – vertical or horizontal – 2½" deep			
CKPM-C-CN	Clear	Grey	6
CKPM-G-CN	Grey	Grey	6
CKPM-W-CN	White	White	6
CKPM-BR-CN	Bronze	Bronze	6
Single-gang large – vertical or horizontal – 4¾" deep			
CKPL-C-CN	Clear	Grey	4
Two-gang medium – 2½" deep			
2CKPM-C-CN	Clear	Grey	4
2CKPM-G-CN	Grey	Grey	4
2CKPM-W-CN	White	White	4
2CKPM-BR-CN	Bronze	Bronze	4
Two-gang large – 4¾" deep			
2CKPL-C-CN	Clear	Grey	4

Red Dot nonmetallic covers

Code Keeper universal nonmetallic weatherproof while-in-use covers

Diagrams

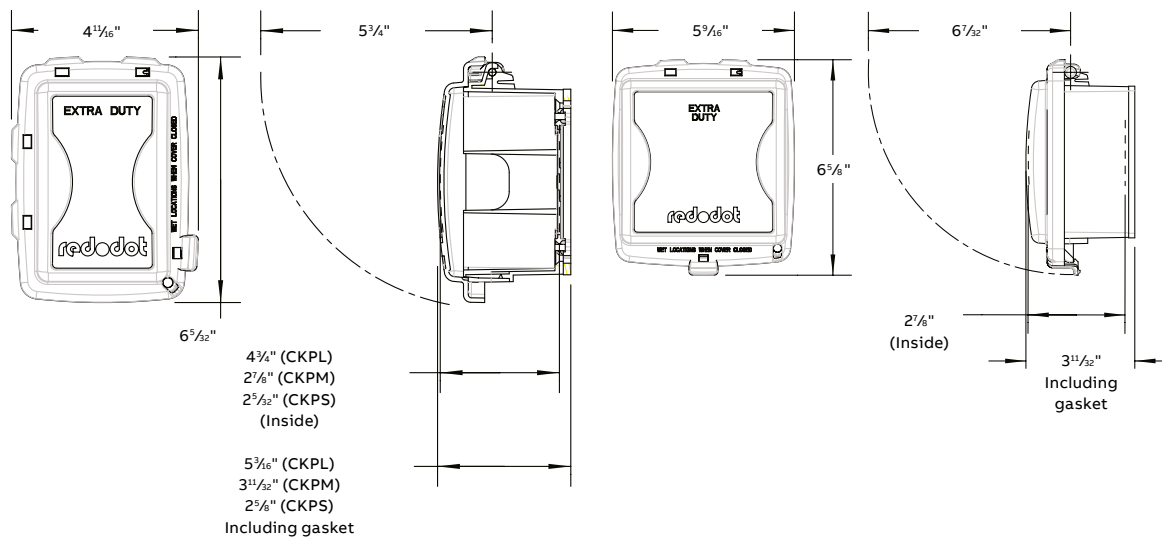
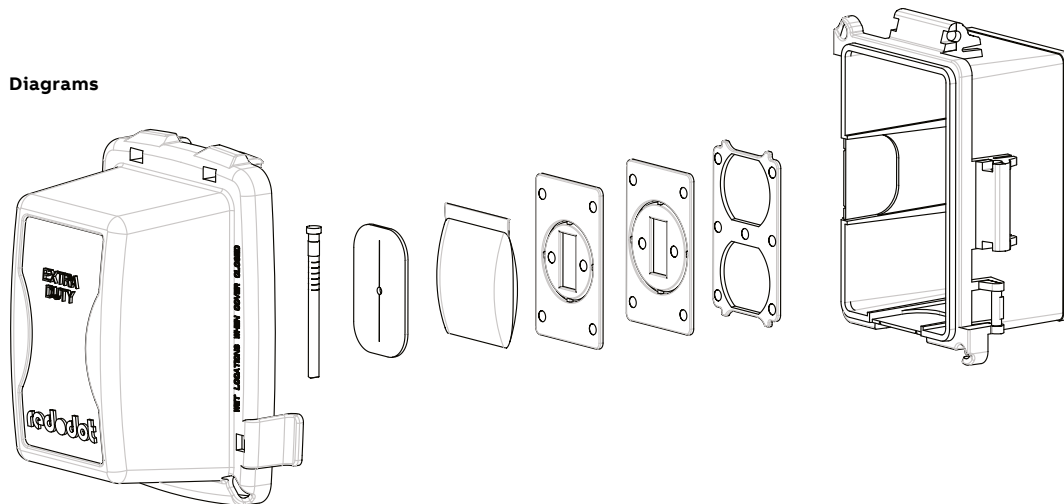

Single-gang (CKPM) – dimensions

Two-gang (2CKPM) – dimensions

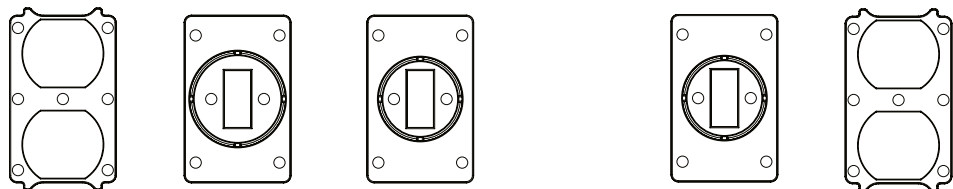



Single-gang base options
GFI, duplex, switch, up to 1 5/8" rounds

Two-gang base options
GFI, duplex, switch and 1 3/8" round receptacle





Red Dot Weatherproof kits

Metallic and nonmetallic

Metallic single-gang universal GFCI receptacle kit with “Extra-Duty” while-in-use cover, weather- and tamper-resistant, horizontal or vertical

	Cat. no.	Colour	Description	Std. ctn.
	S355E-CN	Grey box with grey cover	Metallic box with three ½ in. hubs, 17.3 cu. in., metallic cover, ground screw, vertical only	4
	S355P-CN	Grey box with clear cover	Metallic box with three ½ in. hubs, 17.3 cu. in., nonmetallic cover, ground screw	4

Nonmetallic “Extra-Duty” while-in-use kits with GFCI receptacle

	Cat. no.	Colour	Description	Std. ctn.
	CKPS-C-CN-KIT	Grey box with clear cover	Box and while-in-use cover kit. Single-gang device box, 2 in. deep, 3 hubs ½ in. Grey with mounting lugs, two closure plugs and ground screw. Single-gang while-in-use extra duty shallow cover, 2¼ in. Deep clear, nonmetallic and GFCI receptacle.	4
	CKPS-W-CN-KIT	White box with white cover	Box and while-in-use cover kit. Single-gang device box, 2 in. deep, 3 hubs ½ in. White with mounting lugs, two closure plugs and ground screw. Single-gang while-in-use extra duty shallow cover, 2¼ in. deep, white, nonmetallic and GFCI receptacle.	4
	CKPM-W-CN-KIT	White box with white cover	Box and while-in-use cover kit. Single-gang device box, 2 in. deep, 3 hubs ½ in. White with mounting lugs, two closure plugs and ground screw. Single-gang while-in-use extra duty medium cover, 2¾ in. deep, white, nonmetallic and GFCI receptacle.	4
	CKPS-BR-CN-KIT	Bronze box with bronze cover	Box and while-in-use cover kit. Single-gang device box, 2 in. deep, 3 hubs ½ in. Bronze with mounting lugs, two closure plugs and ground screw. Single-gang while-in-use extra duty shallow cover, 2¼ in. deep, bronze, nonmetallic and GFCI receptacle.	4
	CKPM-BR-CN-KIT	Bronze box with bronze cover	Box and while-in-use cover kit. Single-gang device box, 2 in. deep, 3 hubs ½ in. Bronze with mounting lugs, two closure plugs and ground screw. Single-gang while-in-use extra duty medium cover, 2¾ in. deep, bronze, nonmetallic and GFCI receptacle.	4

Red Dot Weatherproof kits

Metallic and nonmetallic

Nonmetallic "Extra-Duty" while-in-use kits with GFCI receptacle (continued)

	Cat. no.	Colour	Description	Std. ctn.
	CKPS-C-CN-PKIT	Grey box with clear cover	Box and while-in-use cover kit. Single-gang device PVC box grey, 3 threaded hubs ½ in. with ground screw. Single-gang while-in-use extra duty shallow cover, 2¼ in. deep clear, nonmetallic and GFCI receptacle.	4
	CKPS-W-CN-PKIT	White box with white cover	Box and while-in-use cover kit. Single-gang device PVC box white, 3 threaded hubs ½ in. with ground screw. Single-gang while-in-use extra duty shallow cover, 2¼ in. deep white, nonmetallic and GFCI receptacle.	4
	CKPM-C-CN-PKIT	Grey box with clear cover	Box and while-in-use cover kit. Single-gang device PVC box grey, 3 threaded hubs ½ in. with ground screw. Single-gang while-in-use extra duty medium cover, 2⅞ in. deep clear, nonmetallic and GFCI receptacle.	4
	CKPM-W-CN-PKIT	White box with white cover	Box and while-in-use cover kit. Single-gang device PVC box white, 3 threaded hubs ½ in. with ground screw. Single-gang while-in-use extra duty medium cover, 2⅞ in. deep white, nonmetallic and GFCI receptacle.	4
	CKPL-C-CN-PKIT	Grey box with clear cover	Box and while-in-use cover kit. Single-gang device PVC box, grey, 3 threaded hubs ½ in. with ground screw. Single-gang while-in-use extra duty large cover, 4¼ in. deep, clear, nonmetallic and GFCI receptacle.	3
	2CKPM-C-CN-PKIT	Grey box with clear cover	Box and while-in-use cover kit. Double-gang device PVC box, grey, 3 threaded hubs 1 x ½ in. 2 x ¾ in. With ground screw. Double-gang while-in-use extra duty cover, 2⅞ in. deep, clear, nonmetallic and 2 GFCI receptacles.	4

Red Dot Weatherproof metallic boxes

Universal boxes and covers

Applications:

- Dry-Tite boxes and covers protect wiring devices, switches, electronic components and terminal blocks in dry, damp and wet locations
- Accessible wiring chamber provides a convenient location to maintain or change a system, pull conductors and make splices
- Junction box for branch conduits

Features/benefits:

- Aluminum alloy, zinc alloy and stainless steel springs provide increased corrosion resistance
- Die-cast construction and industrial design combine to produce a rugged protective enclosure for devices on many applications
- Clean cover edges provide good gasket sealing
- Precision-cast and machined surfaces permit safer wire pulling
- Clear UL, CSA and cubic content markings speed approval by inspectors
- Convenient mounting lugs for a variety of mounting methods
- Securely fastened mounting plates reduce costly callbacks

Standard materials:

- Boxes: Die-cast aluminum alloy
- Cover plates: Stamped aluminum alloy or die-cast zinc alloy
- Cover lids: Die-cast zinc alloy

Standard finish:

- Powder-coated finish

Compliances:

- UL listed (UL File No. E-28688)
- Boxes: CSA certified with factory-installed ground screw
- Covers: CSA certified
- Covers suitable for use in wet locations with covers closed
- CCB and CCT series covers suitable for use in wet locations
- NEMA 3R rated

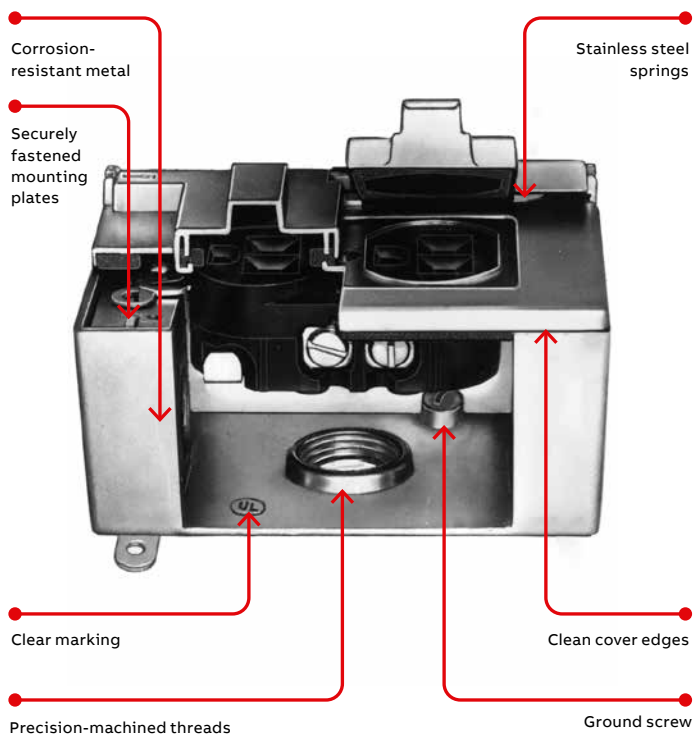

2CCT



2IH5-1



CCD



IH3-1-LM

Accessible wiring chamber provides a convenient location to pull conductors and make splices in dry, damp or wet locations.

- Maximum cubic capacity
- Securely fastened mounting plates
- Corrosion-resistant materials
- Powder-coated finish
- Ground screw included
- Precision-machined threads
- Clear UL, CSA and cubic volume marking

Red Dot Weatherproof metallic boxes

Universal boxes and covers

Single-gang – 2" deep



	Cat. no.	Hub size (in.)	Colour	Std. ctn.	
Three outlets					
	S105CN	IH3-1-LM•	½	Grey	50
		S100CN*	½	Grey	20
		S100BRCN*	½	Bronze	25
		S100WHCN*	½	White	25
		S105CN*	¾	Grey	25
D-PAK					
	DIH3-1-LM•	½	Grey	10	
	DIH3-1-LM-WH•	½	White	10	
	DIH3-2-LM•	¾	Grey	10	
	B13030G	1		10	

Four outlets

	IH4-1	IH4-1	½	Grey	50
		IH4-2	¾	Grey	50
		IH4-1-LM•	½	Grey	50
		IH4-2-LM•	¾	Grey	50
D-PAK					
	DIH4-2-LM•	¾	Grey	10	

Five outlets

	IH5-1	IH5-1-LM•	½	Grey	25
		IH5-2-LM•	¾	Grey	25
		S102CN*	½	Grey	20
		S107CN*	¾	Grey	16

Five outlets (2-side)

	B1501SGR	B1501SGR	½	Grey	16
		B1502SG	¾	Grey	25



Note: Raintight when used with appropriate Red Dot covers. Boxes supplied with 2 closure plugs and ground screw.

• With mounting lugs

* With mounting lugs and French/English retail packaging

Two-gang – 2" deep



	Cat. no.	Hub size (in.)	Colour	Std. ctn.	
Three outlets					
	S400CN	2IH3-2•	¾	Grey	10
		S400CN*	½	Grey	12
Four outlets					
	2IH4-1	2IH4-1•	½	Grey	10
		2IH4-2•	¾	Grey	10

Five outlets

	2IH5-1	2IH5-1•	½	Grey	10
		S401CN*	½	Grey	12
		S402CN*	¾	Grey	12

Five outlets (2-side)

	2IH5S2-1	2IH5S2-1•	½	Grey	10
		2IH5S2-2•	¾	Grey	10

Seven outlets

	2IH7-1	2IH7-1•	½	Grey	10
		2IH7-2•	¾	Grey	10

Seven outlets (2-side)

	2IH7S2-1	2IH7S2-1•	½	Grey	10
		2IH7S2-2•	¾	Grey	10

Note: Raintight when used with appropriate Red Dot covers. Boxes supplied with 2 closure plugs and ground screw.

• With mounting lugs

* With mounting lugs and French/English retail packaging

Red Dot Weatherproof metallic boxes

Universal boxes and covers

Deep boxes – Single- and multi-gang – 2 1/2" deep



	Cat. no.	Hub size (in.)	Colour	Std. ctn.
Three outlets				
	IHD3-1•	1/2	Grey	10
	IHD3-2•	3/4	Grey	10
	IHD3-3•	1	Grey	10

Four outlets

	Cat. no.	Hub size (in.)	Colour	Std. ctn.
	IHD4-1•	1/2	Grey	10
	IHD4-2•	3/4	Grey	10

Two-gang five outlets

	Cat. no.	Hub size (in.)	Colour	Std. ctn.
	2IHD5-1•	1/2	Grey	5
	2IHD5-2•	3/4	Grey	5
	2IHD5-3•	1	Grey	5

Three-gang seven outlets

	Cat. no.	Hub size (in.)	Colour	Std. ctn.
	B37D20G	3/4	Grey	5
	B37D30G	1	Grey	5

Note: Raintight when used with appropriate Red Dot covers. Boxes supplied with 2 closure plugs and ground screw.

• With mounting lugs

* With mounting lugs and French/English retail packaging

Close-up plugs – Zinc



	Cat. no.	Hub size (in.)	Colour	Material	Std. ctn.
	PLG-1-RD	1/2	Grey	Zinc	100
	PLG-2-RD	3/4	Grey	Zinc	100
	PLG-3-RD	1	Grey	Zinc	100

Red Dot Weatherproof metallic boxes

Universal boxes and covers

Extensions – Single-gang



Cat. no.	Hub size (in.)	Description	Colour	Std. ctn.
Four outlets – 1 1/8" deep				
S121E-R-CN	S121E-R-CN	1/2 4-hole extension ring for one-gang box with 4 plugs, gasket and screws	Grey	6



Two outlets, flanged – 1 1/8" deep add on

IHEF2-1	IHEF2-1	1/2 2-hole flanged box extension adapter with 1 plug gasket and screws	Grey	5
	IHEF2-2	3/4	Grey	5



Six outlets, flanged – 1 1/8" deep add on

IHEF6S2-1	IHEF6S2-1	1/2 6-hole flanged box extension adapter with 4 plugs, gasket and screws	Grey	5
	IHEF6S2-2	3/4	Grey	5



Mounting lugs



Cat. no.	Description	Colour	Std. ctn.
LM	2 Mounting lugs with self-tapping screws, for LM boxes only	Grey	100



Red Dot Weatherproof metallic boxes

Universal boxes and covers

Cat. no.	Hub size (in.)	Dimensions (in.)									
		A	B	C	D	E	F	G	H	J	CI
IH-1	1/2	4 9/16	2 13/16	2	5/8	-	-	3 1/4	1 1/8	1 1/2	17.3
IH-2	3/4	4 9/16	2 13/16	2	5/8	-	-	3 1/4	1 1/8	1 1/2	17.0
IH-LM-1	1/2	4 9/16	2 13/16	2	5/8	3 13/16	3 1/2	3 1/4	1 1/8	1 1/2	17.3
IH-LM-2	3/4	4 9/16	2 13/16	2	5/8	3 13/16	3 1/2	3 1/4	1 1/8	1 1/2	17.0
IH-S-1	1/2	4 9/16	2 13/16	2	5/8	3 13/16	3 1/2	3 1/4	1 1/8	1 1/2	17.0
IH-S-2	3/4	4 9/16	2 13/16	2	5/8	3 13/16	3 1/2	3 1/4	1 1/8	1 1/2	17.0
IHD3-1	1/2	4 9/16	2 13/16	2 5/8	5/8	3 13/16	3 1/2	3 1/4	1 1/8	1 1/2	24.8
IHD3-2	3/4	4 9/16	2 13/16	2 5/8	5/8	3 13/16	3 1/2	3 1/4	1 1/8	1 1/2	24.8
IHD3-3	1	4 9/16	2 13/16	2 5/8	3/4	3 13/16	3 1/2	3 1/4	1 1/8	1 1/2	23.5

Diagrams

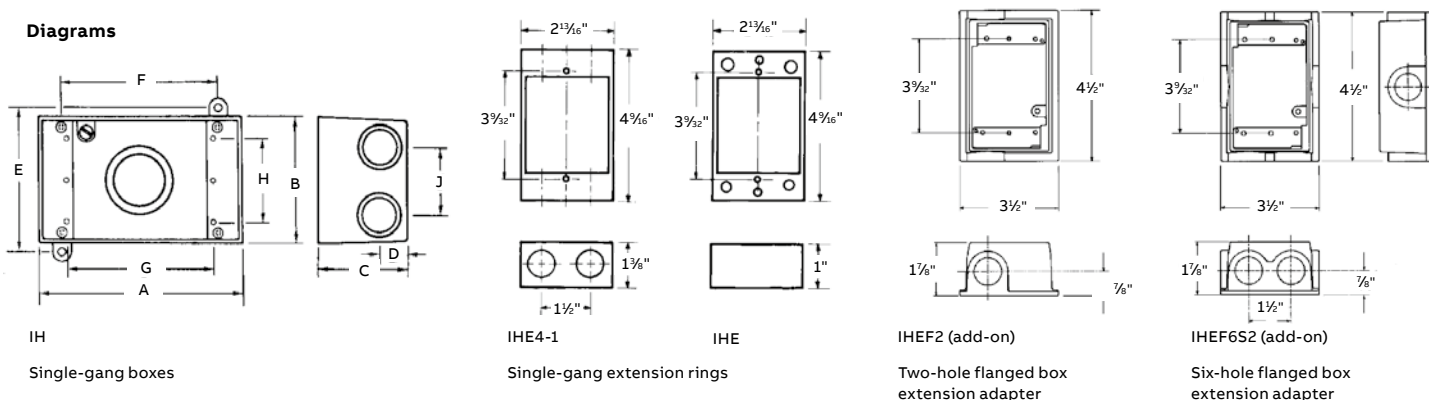

IH
Single-gang boxes

IHE4-1
Single-gang extension rings

IHE

IHEF2 (add-on)
Two-hole flanged box extension adapter

IHEF6S2 (add-on)
Six-hole flanged box extension adapter

Cat. no.	Dimensions (in.)												
	A	B	C	D	E	F	G	H	J	K	L	M	CI
2IH3	4 9/16	4 5/8	2 1/16	5/8	5	3 1/2	3 17/32	3 3/4	-	-	3 1/4	3 3/16	31.8
2IH4	4 9/16	4 5/8	2 1/16	5/8	5	3 1/2	3 17/32	3 3/4	1 1/2	-	3 1/4	3 3/16	31.8
2IH5	4 9/16	4 5/8	2 1/16	5/8	5	3 1/2	3 17/32	3 3/4	1 1/2	-	3 1/4	3 3/16	31.8
2IH5S2	4 9/16	4 5/8	2 1/16	5/8	5	3 1/2	3 17/32	3 3/4	-	-	3 1/4	3 3/16	31.8
2IH7	4 9/16	4 5/8	2 1/16	5/8	5	3 1/2	3 17/32	3 3/4	-	1 1/2	3 1/4	3 3/16	30.3
2IH7S2	4 9/16	4 5/8	2 1/16	5/8	5	3 1/2	3 17/32	3 3/4	1 1/2	-	3 1/4	3 3/16	32.0
2IHD5	4 9/16	4 5/8	2 17/32	3/4	5	3 1/2	3 17/32	3 3/4	1 3/16	-	3 1/4	3 3/16	40.3
B37D20G	4 9/16	6 7/16	2 11/16	1 3/16	6 13/16	3 1/2	3 3/4	5 5/8	-	1 1/2	3 1/4	3 3/16	54.8
B37D30G	4 9/16	6 7/16	2 11/16	1 3/16	6 13/16	3 1/2	3 3/4	5 5/8	-	1 1/2	3 1/4	3 3/16	54.8

Diagrams

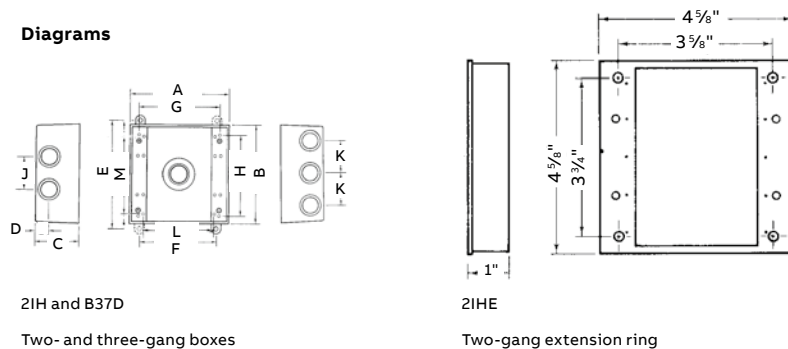

2IH and B37D
Two- and three-gang boxes

2IHE
Two-gang extension ring

Red Dot Weatherproof metallic covers

Universal flip-lid weatherproof covers



CCU

Universal design installs in both horizontal and vertical applications

Red Dot universal flip-lid weatherproof covers save you time and money by reducing the number of items you have to inventory to complete a job. Capable of mounting either vertically or horizontally, the covers provide added versatility with innovative adapter plates to support all of the most common installation configurations – 10 with the single-gang cover and 25 with the 2-gang cover. Choose from grey, bronze or white covers.

Features:

- Included adapter plates offer 10 installation options with single-gang cover and 25 installation options with 2-gang cover
- Keyhole openings on back enable easy installation on an existing outlet
- Durable, die-cast zinc-alloy construction
- Suitable for use in wet locations with cover closed
- Available in grey, bronze and white
- Lockable for security when not in use
- Easy access to outlet with 130° opening
- Preconfigured for GFCI – the industry’s most common outdoor application

Accommodates multiple outlet configurations (receptacles not included)



GFCI



Duplex



Single receptacle



Switch



Includes two adapter plates



Cat. no.	Description	Colour	Std. ctn.
CCU	Single-gang cover (installs vertically or horizontally)	Grey	50
DCCU	D-PAK – single-gang cover	Grey	25
DCCU-BR	D-PAK – single-gang cover	Bronze	25
DCCU-WH	D-PAK – single-gang cover	White	25
2CCU	2-Gang cover	Grey	10

Red Dot Weatherproof metallic covers

Universal flip-lid weatherproof covers

Single-gang device covers



	Cat. no.	Colour	Description	Std. ctn.
--	----------	--------	-------------	-----------

Duplex receptacle cover, horizontal

CCD	CCD	Grey	Device mount	50
-----	-----	------	--------------	----



Duplex receptacle cover, horizontal

S310	S310E-R	Grey	Device mount	20
	S310BRE	Bronze	Device mount	12
	S310WHE	White	Device mount	12



Duplex receptacle cover, vertical

CCDV	CCDV	Grey	Device mount	25
------	------	------	--------------	----



GFCI receptacle cover, horizontal

CCG	CCG	Grey	Device mount	25
	D-PAK			
	DCCG	Grey	Device mount	16
	DCCG-BR	Bronze	Device mount	16
	DCCG-WH	White	Device mount	16



GFCI receptacle cover, horizontal

S305	S305E	Grey	Device mount	24
	S305BRE	Bronze	Device mount	12
	S305WHE	White	Device mount	12



GFCI receptacle cover, vertical

CCGV	CCGV	Grey	Device mount	25
	CCGV-L	Grey	Device mount with lock option	25



	Cat. no.	Colour	Description	Std. ctn.
--	----------	--------	-------------	-----------

GFCI receptacle cover, vertical

S306	S306E	Grey	Device mount	24
	S306BRE	Bronze	Device mount	10
	S306WHE	White	Device mount	10



Note: All covers packed with gasket and screws.

Single receptacle cover, horizontal – 1.485" diameter opening

CCS	CCS	Grey	Device mount	25
-----	-----	------	--------------	----



Single receptacle cover, vertical – 1.59"/2.156" diameter opening

CCSV	CCSV	Grey	Device mount	25
	CCSV-L	Grey	Device mount with lock option	25
	CCPO	Grey	Power outlet cover with 2.156" diameter opening, box mount	25

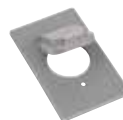

Universal cover for GFCI, single receptacle, duplex receptacle or switch, horizontal or vertical

DCCU	DCCU	Grey	Preconfigured for GFCI, supplied with 2 adapters and 2 screws, lockable	25
	DCCU-BR	Bronze		25
	DCCU-WH	White		25



Switch cover only

CCT	CCT	Grey	Device mount switch cover only, packed with spacers and screws	25
-----	-----	------	--	----



Note: Raintight when used with appropriate Red Dot boxes. All covers packed with gasket and screws.

Red Dot Weatherproof metallic covers

Universal flip-lid weatherproof covers

Single-gang device covers



	Cat. no.	Colour	Description	Std. ctn.
Switch cover with switch				
	CCT-1	Grey	Single-pole 15 A, 125 V	10
	CCT-1-20	Grey	Single-pole 20 A, 120-277 V	10
	SW1	Grey	One-gang cover with 10 A, 125 V single-pole switch	25
	S321E	Grey	One-gang cover with switch, packed with spacers	12

UL Listed E-18407.
CSA Certified LR-016807.

Single-gang gasket

	Cat. no.	Colour	Description	Std. ctn.
CCK	CCK	Black	Neoprene	40



	N° cat.	Couleur	Description	Ctn std
S620E-R	S620E-R	Noir	Néoprène	50

Two-gang device covers



	Cat. no.	Colour	Description	Std. ctn.
Two-duplex receptacle cover				
	2CCD	Grey	Device mount, aluminum	10
	S410E	Grey	Self-closing lids, zinc	9

Two-gang device-mount cover (zinc)

S413E	S413E	Grey	For two GFCI receptacles	8
-------	-------	------	--------------------------	---



Two-GFCI receptacle cover

2CCG	2CCG	Grey	Device mount	10
------	------	------	--------------	----



One duplex and one GFCI receptacle cover

2CCDG	2CCDG	Grey	Device mount	10
-------	-------	------	--------------	----



Two-single receptacle cover – 1.485" diameter opening

2CCS	2CCS	Grey	Device mount	10
------	------	------	--------------	----





Note: Raintight when used with appropriate Red•Dot boxes. All covers packed with gasket and screws.

Red Dot Weatherproof metallic covers

Universal flip-lid weatherproof covers



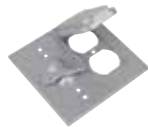

Two-gang device covers



	Cat. no.	Colour	Description	Std. ctn.
Double switch cover				
	2CCT	Grey	Cover only, packed with spacers	10
Switch and one duplex receptacle cover				
	2CCTD	Grey	Cover only, packed with spacers	10
Universal cover for GFCI, single receptacle, duplex receptacle or switch, horizontal or vertical (zinc)				
	2CCU	Grey	Preconfigured for GFCI, supplied with 4 adapters and 4 screws, lockable	10

Blank covers



	Cat. no.	Colour	Description	Std. ctn.
Single-gang				
	CCB*	Grey	Powder-coated steel device mount	100
	CCB-FS	Grey	Blank stamped aluminum cover, box mount	100
Single-gang device mount covers				
	S340E-R	Grey	Powder-coated steel device mount	20
	S340BRE-R-CN*	Bronze	Powder-coated steel device mount	20
	S340WHE-R-CN*	White	Powder-coated steel device mount	20
Two-gang				
	2CCB	Grey	Powder-coated steel device mount	50
Two-gang device mount covers				
	S440E-R	Grey	Blank cover, two gang (powder-coated steel)	20
Three-gang				
	3CCB	Grey	Powder-coated steel box mount	25

Note: Raintight when used with appropriate Red•Dot boxes. All covers packed with gasket and screws.

*cULus

Two-gang gasket

	Cat. no.	Colour	Description	Std. ctn.
	R104	Black	Two-gang gasket	100

Red Dot Weatherproof metallic covers

Universal flip-lid weatherproof covers

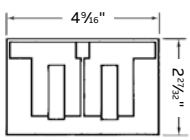

CCD

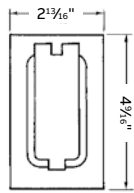

CCDV and CCGV

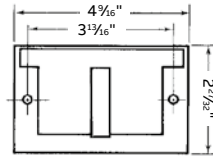

CCG

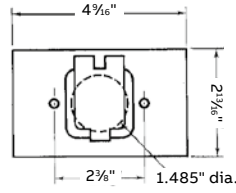

CCS

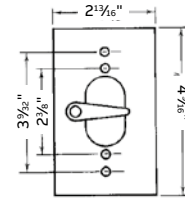

CCT

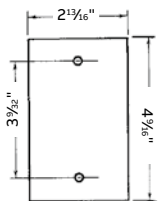

CCB

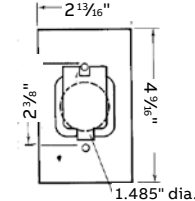

CCV

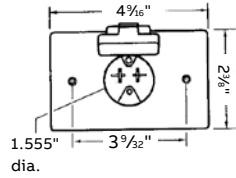

CCMB

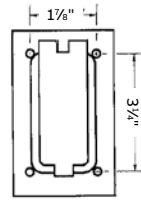

Typical FS mount hole pattern

Single-gang covers

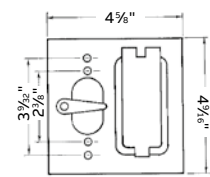

2CCTD

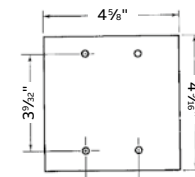

2CCB

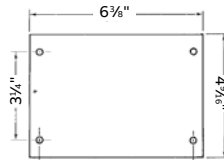

3CCB

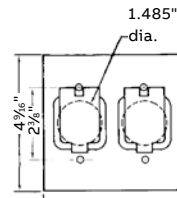

2CCS

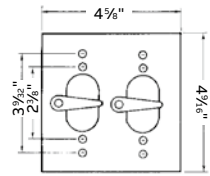

2CCT

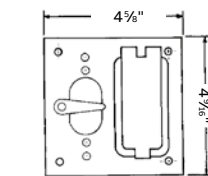

2CCTG-FS

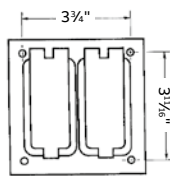

Typical FS mount hole pattern

Two- and three-gang covers

Carlson Weatherproof nonmetallic boxes

Nonmetallic weatherproof boxes



Type FSE single-gang box

- For dead-end terminations
- Mounting feet included
- 18 cu. in. volume
- Grounding strap included

FSEB-050



Cat. no.	Colour	Size (in.)	Std. ctn.
FSEB-050	Grey	½	12
FSEB-075	Grey	¾	12
FSEB-100	Grey	1	8



Type FSS single-gang box

- For multiple dead-end terminations or where additional support is required in stub-up applications
- Mounting feet included
- 18 cu. in. volume
- Grounding strap included

FSSB-050



Cat. no.	Colour	Size (in.)	Std. ctn.
FSSB-050	Grey	½	12
FSSB-075	Grey	¾	12
FSSB-100	Grey	1	8



Type FSC single-gang box

- For through terminations
- Mounting feet included
- 18 cu. in. volume
- Grounding strap included

FSCB-050



Cat. no.	Colour	Size (in.)	Std. ctn.
FSCB-050	Grey	½	12
FSCB-075	Grey	¾	12
FSCB-100	Grey	1	8



Type FSCC single-gang box

- For multiple through terminations or where additional support is required in stub-up applications
- Mounting feet included
- 18 cu. in. volume
- Grounding strap included

C979EFN



Cat. no.	Colour	Size (in.)	Std. ctn.
C979EFN	Grey	¾	15
C979FFN	Grey	1	15



Single-gang T box

- With three ½" threaded holes
- Mounting feet included
- Use with nonmetallic wiring systems only
- Grounding strap included
- Can be used with Red Dot lampholder

WPB-T050-G



Cat. no.	Colour	Size (in.)	Std. ctn.
WPB-T050-G	Grey	½	8
WPB-T050-W	White	½	5

Carlson Weatherproof nonmetallic boxes

Nonmetallic weatherproof boxes



Type FDE single-gang deep box

- For dead-end terminations where large device or where additional support is required
- Mounting feet included
- 25 cu. in. volume
- Grounding strap included

C9801EN



Cat. no.	Colour	Size (in.)	Std. ctn.
C9801DN	Grey	½	10
C9801EN	Grey	¾	10

Diagrams

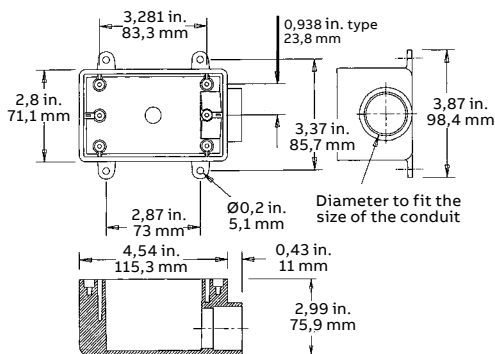

Type FDC single-gang deep box

- For through terminations where large device or where additional support is required
- Mounting feet included
- 25 cu. in. volume
- Grounding strap included

C9811EN



Cat. no.	Colour	Size (in.)	Std. ctn.
C9811EN	Grey	¾	10
C9811FN	Grey	1	10

Diagrams

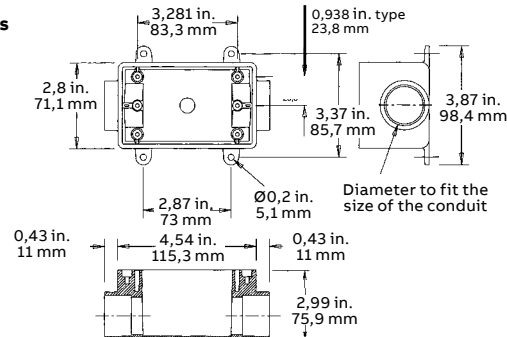

FDB-BLANK

Type FD single-gang deep box

- For terminations where hub requirements vary according to application
- Hubs can be added easily with flared wood bit or hole saw
- Mounting feet included
- 18 cu. in. volume
- Grounding strap included



Cat. no.	Colour	Size (in.)	Std. ctn.
FDB-BLANK	Grey	-	6

Diagrams

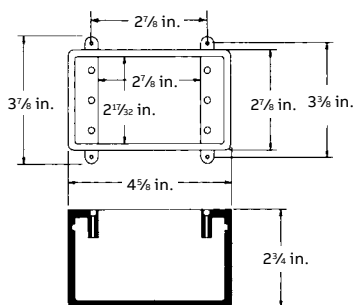

WPRB-T050-W

Round T box

- With five ½" threaded holes
- Mounting feet included
- Use with nonmetallic wiring systems only
- Grounding strap included
- Can be used with Red Dot lampholder



Cat. no.	Colour	Size (in.)	Std. ctn.
WPRB-T050-G	Grey	½	8
WPRB-T050-W	White	½	8



WPRNDCV-G

Round T box flat cover

- Gasket included



Cat. no.	Colour	Std. ctn.
WPRNDCV-G	Grey	20
WPRNDCV-W	White	20

Carlson Weatherproof nonmetallic boxes

Nonmetallic weatherproof boxes



Type FSE 2-gang box

- For dead-end terminations where two devices or additional capacity is required
- Mounting feet included
- 32 cu. in. volume
- Grounding strap included

FSEB2-075



Cat. no.	Colour	Size (in.)	Std. ctn.
FSEB2-050	Grey	½	5
FSEB2-075	Grey	¾	10
FSEB2-100	Grey	1	4

Diagrams

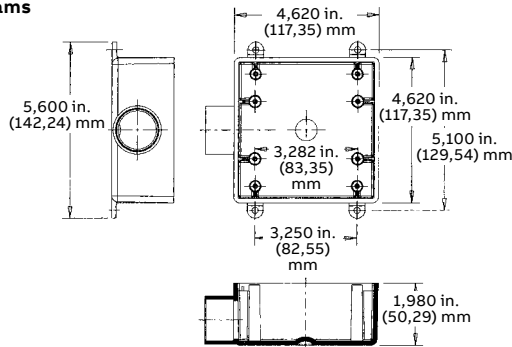

Type FSC 2-gang box

- For through terminations where two devices or additional capacity is required
- Mounting feet included
- 32 cu. in. volume
- Grounding strap included

FSCB2-050



Cat. no.	Colour	Size (in.)	Std. ctn.
FSCB2-050	Grey	½	4
FSCB2-075	Grey	¾	10
FSCB2-100	Grey	1	10

Diagrams

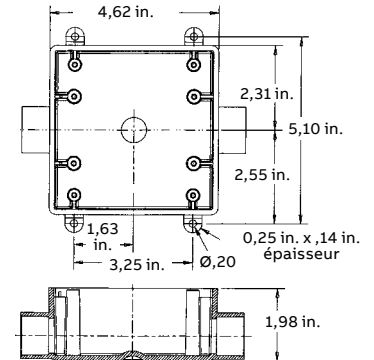

CE9802

Type FS 2-gang box

- For terminations where hub requirements vary according to application
- Hubs can be added easily with flared wood bit or hole saw
- Mounting feet included
- 32 cu. in. volume
- Grounding strap included

Cat. no.	Colour	Size (in.)	Std. ctn.
CE9802	Grey	-	10

Schémas

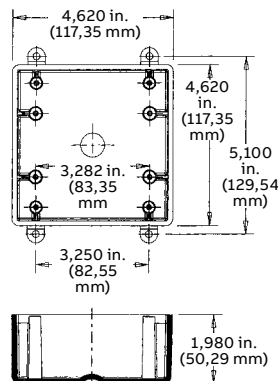

WPB2-T7550-G

2-Gang T box

- With three ½" and four ¾" threaded holes
- Mounting feet included
- Use with nonmetallic wiring systems only
- Grounding strap included
- Can be used with Red Dot lampholder



Cat. no.	Colour	Size (in.)	Std. ctn.
WPB2-T7550-G	Grey	½-¾	6
WPB2-T7550-W	White	½-¾	6

Carlton Weatherproof nonmetallic covers

Single gang – Vertical mount

- For use in wet/damp locations
- Mounts to a box or device
- Nonmetallic
- Paintable
- Easy to install

Single gang – Vertical mount



	Cat. no.	Colour	Std. ctn.
GFCI receptacle			
	WPCV-GFI-V-G	Grey	10
	WPCV-GFI-V-W	White	10
	WPCV-GFI-V-B	Bronze	10

Duplex receptacle

	Cat. no.	Colour	Std. ctn.
	WPCV-DUP-V-G	Grey	10
	WPCV-DUP-V-W	White	10

20-Amp receptacle

	Cat. no.	Colour	Std. ctn.
	E98G20N	Grey	20

For 20-amp or other single receptacle under 1.625" diameter

50-Amp receptacle

	Cat. no.	Colour	Std. ctn.
	WPCV-50A-G	Grey	10

For 50-amp or other single receptacle under 2.25" diameter

Toggle switch

	Cat. no.	Colour	Std. ctn.
	WPCV-TOG-G	Grey	5
	WPCV-TOG-W	White	5



	Cat. no.	Colour	Std. ctn.
Blank cover			
	WPCV-BLK-G	Grey	12
	WPCV-BLK-W	White	12

Supplied with gasket and stainless steel mounting screw

15-Amp receptacle

	Cat. no.	Colour	Std. ctn.
	WPCV-15A-G	Grey	10

For 15-amp or other single receptacle under 1.375" diameter

30-Amp receptacle

	Cat. no.	Colour	Std. ctn.
	E98G30N-CAR	Grey	10

For 30-amp or other single receptacle under 1.75" diameter

Single switch

	Cat. no.	Colour	Std. ctn.
	WPCV-SSW-G	Grey	10

Plunger switch

	Cat. no.	Colour	Std. ctn.
	E98PSC	Grey	20

Carlton Weatherproof nonmetallic covers

Single gang – Horizontal mount and two-gang

- For use in wet/damp locations
- Mounts to a box or device
- Nonmetallic
- Paintable
- Easy to install

Single gang – Horizontal mount



	Cat. no.	Colour	Std. ctn.
Duplex receptacle			
	WPCV-DUP-H-G	Grey	10
	WPCV-DUP-H-W	White	10

GFCI receptacle

	Cat. no.	Colour	Std. ctn.
	WPCV-DUP-V-G	Grey	10
	WPCV-GFI-H-W	White	10
	WPCV-GFI-H-B	Bronze	10

Two-gang



	Cat. no.	Colour	Std. ctn.
2-gang blank cover			
	WPCV2-BLK-G	Grey	10

Supplied with gasket and stainless steel mounting screw

Combination toggle / GFCI

	Cat. no.	Colour	Std. ctn.
	WPCV2-GFISWG	Grey	3

Double toggle

	Cat. no.	Colour	Std. ctn.
	WPCV2-TOG-G	Grey	3

Double duplex receptacle

	Cat. no.	Colour	Std. ctn.
	WPCV2-DUP-G	Grey	10
	WPCV2-DUP-W	White	

Combination toggle / duplex receptacle

	Cat. no.	Colour	Std. ctn.
	WPCV2-DUPSWG	Grey	10

Carlton Weatherproof nonmetallic covers

Cover plates for indoor use only

Single gang – Mount on box



	Cat. no.	Colour	Std. ctn.
--	----------	--------	-----------

Toggle switch

FSCV-SW-G	FSCV-SW-G	Grey	5
-----------	-----------	------	---



Duplex receptacle

FSCV-DUP-G	FSCV-DUP-G	Grey	5
------------	------------	------	---



Single gang – Mount on device

	Cat. no.	Colour	Std. ctn.
--	----------	--------	-----------

Toggle switch

E98TSCN	E98TSCN	Grey	100
---------	---------	------	-----



2-gang – Mount on box



	Cat. no.	Colour	Std. ctn.
--	----------	--------	-----------

Double toggle switch

FSCV2-SW-G	FSCV2-SW-G	Grey	5
------------	------------	------	---



Double duplex receptacle

FSCV2-DUP-G	FSCV2-DUP-G	Grey	5
-------------	-------------	------	---



Red Dot Weatherproof metallic boxes

Round boxes, extensions and covers



S-47



SE-48



Applications:

- Junction for branch conduits
- Spacious, accessible wiring chamber provides a convenient location to maintain or change a system, pull conductors and make splices

Features/benefits:

- Copper-free* aluminum provides increased corrosion resistance
- Precision-cast and machined surfaces permit safer wire pulling
- Clean cover edges provide good gasket sealing
- Precision NPT threads enable trouble-free field installation for rigid conduit or EMT fitting
- Deep-slotted zinc plated steel cover screws for faster installation
- Clear UL, CSA and cubic content markings speed approval by inspectors

Standard materials:

- Boxes: Die-cast aluminum alloy
- Cover: Stamped aluminum
- Gaskets: Composition

Standard finish:

- Powder-coated finish

Compliances:

- UL listed and CSA certified

* Less than 0.004% copper content.

Boxes



Cat. no.	Colour	Hub size (in.)	Description	Std. ctn.
Five outlets, 4 1/8" diameter				
S-47	Grey	1/2	5 Outlets, cast	36
S110CN	Grey	1/2	5 Outlets with ground screw	16
S110BRCN	Bronze	1/2	5 Outlets with ground screw	16
S110WHCN	White	1/2	5 Outlets with ground screw	16
S-48	Grey	3/4	Mounting lugs, 4 closure plugs	36
S48CFB	Grey	3/4	Ceiling fan box and cover rated for 50 lb fixture or 35 lb fan	10
D-PAK				
DS-47-BR	Bronze	1/2	5 Outlets	8
DS-47-WH	White	1/2	5 Outlets	8
DS-47B	Grey	1/2	With blank cover	8
DS-48B	Grey	3/4	With blank cover	8

Note: Boxes are raintight when used with appropriate Red Dot covers.

4 1/8" Round extensions



Cat. no.	Colour	Hub size (in.)	Description	Std. ctn.
Four outlets, 4 1/8" diameter, 1 1/2" deep				
S130E-CN	Grey	1/2	4 Outlets	8
SE-48	Grey	3/4	4 Closure plugs, gasket and screws	5

Iberville and Red Dot Weatherproof metallic boxes

Round boxes, extensions and covers



CIC-8444 /
CIC-8448



CIC-8495

Cat. no.	Hub size (in.)		No. of lugs	No. of plugs	Description	A	B	C	D	Volume (cu. in.)	
	Side	Bottom				(in.)	(in.)	(in.)	(in.)		
Weatherproof junction box kits (cast aluminum)											
CIC-8444	4 x 1/2	1/2	2	4 x 1/2	Includes cover, gasket, plugs and mounting screws	1 5/8	3 15/16	5	4 5/16	17.3	
CIC-8446	4 x 3/4	1/2	2	3 x 3/4	Includes cover, gasket, plugs and mounting screws	1 5/8	3 15/16	5	4 5/16	17.3	
	4 x 3/4	1/2	2	1 x 1/2	Includes cover, gasket, plugs and mounting screws	1 5/8	3 15/16	5	4 5/16	17.3	
CIC-8448	4 x 1	1/2	2	3 x 1	Includes cover, gasket, plugs and mounting screws	1 5/8	3 15/16	5	4 5/16	17.3	
	4 x 1	1/2	2	1 x 1/2	Includes cover, gasket, plugs and mounting screws	1 5/8	3 15/16	5	4 5/16	17.3	
Outlet box 4 1/2 dia. (cast aluminum)											
CIC-8495	6 x 1/2	1/2	2	5 x 1/2		-	1 1/2	3 15/16	4 5/8	4 5/16	17.3

Diagrams

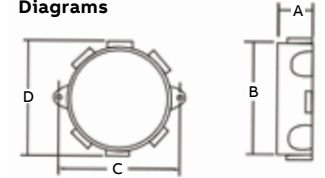

SS-B



CCRSB

Round blank covers



Cat. no.	Colour	Description	Std. ctn.
4 1/2" Diameter			
SS-B	Grey	Weatherproof cover with gasket and screws	15
5" Diameter			
CCRSB	White	Mounting holes 2 3/4" on center (not raintight)	50
CCRB	White	Mounting holes 3 1/2" on center (not raintight)	50

Note: Covers are raintight when used with appropriate Red Dot boxes. All covers packed with gasket and screws.



CIC-93 / S341E-R

Round blank covers



Cat. no.	Description
Weatherproof round cover – 4 3/16 in. dia. (stamped aluminum)	
CIC-93	For 4 in. weatherproof round box; includes gasket and mounting screws
S341E-R*	Round blank weatherproof box cover, colour grey

*cULus



S621E

Round gasket

Cat. no.	Colour	Description	Std. ctn.
S621E	Black	Round gasket	50



PLG-1-RD / PLG-2-RD / PLG-3-RD

Close-up plugs (zinc)



Cat. no.	Colour	Size (in.)	Description
PLG-1-RD	Grey	1/2	Close-up plugs
PLG-2-RD	Grey	3/4	Close-up plugs
PLG-3-RD	Grey	1	Close-up plugs



S603E-R

Nonmetallic plugs



Cat. no.	Colour	Size (in.)	Description
S603E-R	Grey	1/2	Close-up plugs bag/4
S603BRE-R	Bronze	1/2	Close-up plugs bag/4
S603WHE-R	White	1/2	Close-up plugs bag/4

Red Dot Weatherproof metallic lampholders

Lampholder covers

Round lampholder covers

- Heavy-duty die-cast construction
- Powder-coat finish in grey, bronze or white
- Three-hole cover is supplied with a 1/2" closure plug
- Supplied with sealing gasket and cover screw



S-12 S213E-R



S201E LC-21 S203E-R

Standard covers



Cat. no.	Colour	Hub size (in.)	Description	Std. ctn.
Gaskets and screws, 4 1/8" diameter				
S-12	Grey	3/4	One tapped hole	50
S211E	Grey	1/2	One tapped hole	18
S211BRE	Bronze	1/2	One tapped hole	12
S211WHE	White	1/2	One tapped hole	12
S213E-R	Grey	1/2	Three tapped holes	15
S213BRE	Bronze	1/2	Three tapped holes	9
S213WHE	White	1/2	Three tapped holes	9

Single-gang lampholder covers – standard 2 13/16" x 4 1/2"



Cat. no.	Colour	Size (in.)	Description	Std. ctn.
S201E*	Grey	1/2	One-hole device mount	20
S203E-R	Grey	1/2	Three-hole device mount	15
S203BRE	Bronze	1/2	Three-hole device mount	7
S203WHE	White	1/2	Three-hole device mount	7

*cULus



SJ-11 SJ-31

Jumbo covers



Cat. no.	Colour	Hub size (in.)	Description	Std. ctn.
Gaskets and screws, 4 1/2" diameter				
SJ-11	Grey	1/2	One tapped hole	36
SJ-31	Grey	1/2	Three tapped holes	36

Red Dot Weatherproof metallic lampholders

Dimensions and photometrics

Diagrams

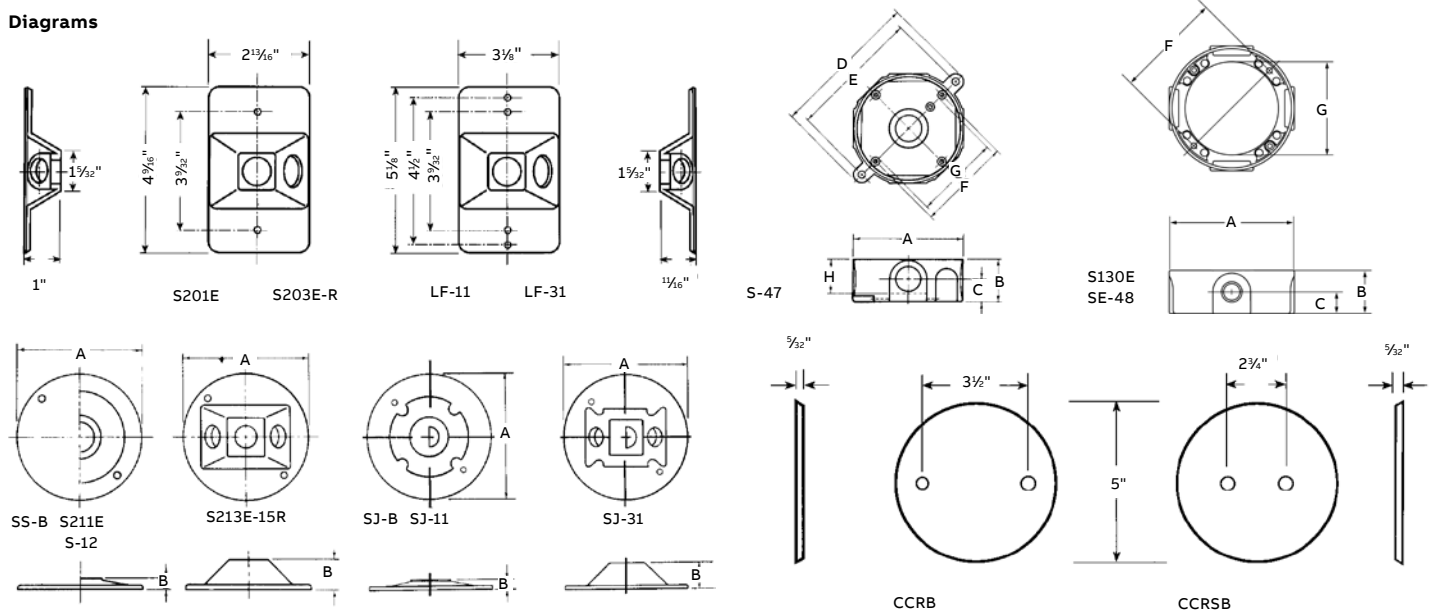

Cat. no.	Hub size	Dimensions (in.)								
		A	B	C	D	E	F	G	H	CI
S-47	1/2	4 1/8	1 5/8	3/4	5 9/16	4 15/16	3 1/2	3 3/8	1 1/4	16.0
S130E	1/2	4 1/8	1 5/8	13/16	-	-	3 1/2	3 1/16	-	18.3
S-48	3/4	4 1/8	1 5/8	7/8	5 9/16	4 15/16	3 1/2	3 3/8	1 1/4	17.0
SE-48	3/4	4 1/8	1 5/8	13/16	-	-	3 1/2	3 1/16	-	18.3
SS-B	-	4 1/8	3/64	-	-	-	-	-	-	-
S211E	1/2	4 1/8	13/32	-	-	-	-	-	-	-
S-12	3/4	4 1/8	3/8	-	-	-	-	-	-	-
S213E-15R	1/2	4 1/8	1 1/16	-	-	-	-	-	-	-
SJ-B	-	4 1/2	3/8	-	-	-	-	-	-	-
SJ-11	1/2	4 1/2	3/8	-	-	-	-	-	-	-
SJ-31	1/2	4 1/2	1	-	-	-	-	-	-	-

Red Dot Weatherproof metallic lampholders

Lampholders, garden lights and accessories

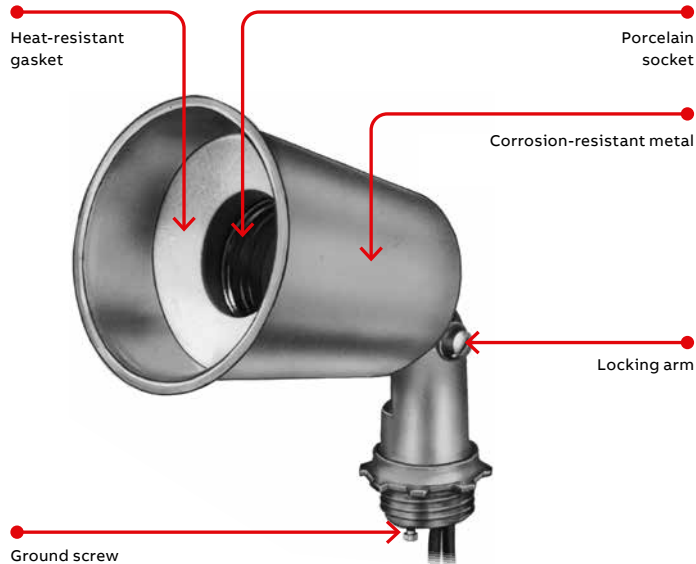

S500EG-CN



S513EG-CN

Applications:

- Security and general outdoor lighting fixture for residential and commercial applications
- Accent lighting fixture for highlighting outdoor signs and architectural details
- Compact outdoor lighting fixture that can be mounted easily in most places and aimed in any direction

Features/benefits:

- Clean lines and precision manufacturing result in a fixture that will enhance any application
- High-quality replaceable porcelain socket with high-temperature leads enables easy field maintenance
- Positive-locking mounting arm keeps fixture in aimed position to reduce costly callbacks
- Ground screw boss in arm

Standard materials:

- Fixture: Zinc die-cast alloy
- Gasket: Heat-resistant composition or high-temperature silicone
- Socket: Center contact, porcelain, medium base

Standard finish:

- Powder-coated finish

Compliances:

- UL listed and CSA certified
- Suitable for use in wet locations

Red Dot Weatherproof metallic lampholders

Lampholders and outlet box kits



S500EG-CN

Lampholders, die-cast zinc



Cat. no.	Colour	Wattage	Description	Std. ctn.
Standard				
S500BREG-CN	Bronze	150W• PAR 38 or R40	Heavy-duty slip-on gasket and ground screw	20
S500WHEG-CN	White	150W• PAR 38 or R40	Heavy-duty slip-on gasket and ground screw	20
S500EG-CN	Grey	150W• PAR 38 or R40	Heavy-duty slip-on gasket and ground screw	20



SPK6-P-GR

Spike lights (zinc)



Cat. no.	Finish	Description
SPK6-P-GR	Green	Portable lamp, 6' cord – metal
SPK6-P-BK	Black	Portable lamp, 6' cord – metal
SPK6-P-BR	Bronze	Portable lamp, 6' cord – metal



S513EG-CN

Decorative floodlight



Cat. no.	Colour	Wattage	Description	Std. ctn.
S513EG-CN	Grey	150W• PAR 38 or R40	Two lampholders, round cover, inside ground screws	8
S513BREG-CN	Bronze	150W• PAR 38 or R40	Two lampholders, round cover, inside ground screws	8
S513WHEG-CN	White	150W• PAR 38 or R40	Two lampholders, round cover, inside ground screws	8

Red Dot Weatherproof metallic lampholders

Lampholders, outlet box kits and vaportight lighting



B228E-R

—
Contemporary floodlight, aluminum



Cat. no.	Colour	Wattage	Description	Std. ctn.
B228E-R	Grey	150W	Two reflectors, round cover, gasket, hardware	2
B228BRE-R	Bronze	150W	Two reflectors, round cover, gasket, hardware	2
B228WHE-R	White	150W	Two reflectors, round cover, gasket, hardware	2



S212G-CN

—
Traditional floodlight



Cat. no.	Colour	Wattage	Description	Std. ctn.
S212G-CN	Grey	150W	Two lampholders, round cover, gasket, round box and hardware	4
S212BRG-CN	Bronze	150W	Two lampholders, round cover, gasket, round box and hardware	4
S212WHG-CN	White	150W	Two lampholders, round cover, gasket, round box and hardware	4



S312E-CN

—
Universal single-gang metallic duplex receptacle outlet box kit, weather- and tamper-resistant, horizontal or vertical

Cat. no.	Colour	Description	Std. ctn.
S312E-CN	Grey	Three ½ in. hubs, 18 cu. in.	4
S312BRE-CN	Bronze	Three ½ in. hubs, 18 cu. in.	4
S312WHE-CN	White	Three ½ in. hubs, 18 cu. in.	4



S315WHE-CN

—
Universal single-gang metallic GFCI receptacle outlet box kit, weather- and tamper-resistant, horizontal or vertical

Cat. no.	Colour	Description	Std. ctn.
S315E-CN	Grey	Three ½ in. hubs, 18 cu. in.	4
S315WHE-CN	White	Three ½ in. hubs, 18 cu. in.	4



MCL150C

MCL150W

—
Ceiling mount and wall mount



Cat. no.	Hub size (in.)	Wattage	Description
Ceiling mount (5 holes)			
MCL150C	1	150W	Can be surface mounted or mounted to a junction box. Kit includes: Aluminum housing, junction box, globe and guard assembly.
Wall mount (5 holes)			
MCL150W	1	150W	Can be surface mounted in a vertical position (globe pointed down only). Kit includes: Aluminum housing, junction box, globe and guard assembly.

Iberville FS and FD products



CIFDC-1/2



CIFST



CFSH-G



2CDR

Applications

- FS boxes are CSA approved
- FS device boxes are installed in applications that require a rugged unit to accept wiring devices, switches, electronic components and terminal blocks
- FS device boxes provide spacious accessible wiring chambers that are a convenient location to maintain or change a system; pull conductors; make splices or branch conduits
- Some FS device boxes, when used with an appropriate cover, provide a raintight installation
- Both weatherproof and dry location covers are available

Features/benefits

- FS device boxes are sand casted or die casted using copper free (less than 0.004% copper content) aluminum alloys.
- FS device boxes incorporate external hub design that provides maximum wiring capacity
- FS device boxes have precision threaded hubs allowing trouble-free field installation of rigid conduit
- FS device boxes are available in 1½ in. and 2½ in. depth
- Carlon nonmetallic weatherproof FS covers are UV-resistant, flame retardant and non-corrosive

Standard materials

- CIFS and CIFD device boxes: Sand-cast, copper-free aluminum (less than 0.004% copper content)
- CIFSU: Die-cast, copper-free aluminum (less than 0.004% copper content)
- FS covers: Die-cast aluminum, sand-cast aluminum or nonmetallic

Compliances



Compliances as noted on each page of the catalogue include:

- CSA certified
- UL listed

Iberville FS and FD products



FS boxes – 1 7/8 in. deep (cast aluminum)



	Cat. no.	Hub size (in.)	No. of gangs	No. of lugs	Std. ctn.
	CIFS-1G-1/2	1 x 1/2	1	3	20
	CIFS-1G-3/4	1 x 3/4	1	3	20
	CIFS-1G-1	1 x 1	1	3	20
	CIFS-2G-1/2	1 x 1/2	2	3	20
	CIFS-2G-3/4	1 x 3/4	2	3	20
	CIFS-2G-1	1 x 1	2	3	20
	CIFS-3G-1/2	1 x 1/2	3	3	10
	CIFS-3G-3/4	1 x 3/4	3	3	10

FSC boxes – 1 7/8 in. deep (cast aluminum)



	Cat. no.	Hub size (in.)	No. of gangs	No. of lugs	Std. ctn.
	CIFSC-1G-1/2	2 x 1/2	1	4	10
	CIFSC-1G-3/4	2 x 3/4	1	4	10
	CIFSC-1G-1	2 x 1	1	4	10
	CIFSC-2G-1/2	2 x 1/2	2	4	10
	CIFSC-2G-3/4	2 x 3/4	2	4	10
	CIFSC-2G-1	2 x 1	2	4	10
	CIFSC-3G-3/4	2 x 3/4	3	4	10

FSCC boxes – 1 7/8 in. deep (cast aluminum)



	Cat. no.	Hub size (in.)	No. of gangs	No. of lugs	Std. ctn.
	CIFSCC-1G-1/2	3 x 1/2	1	3	10
	CIFSCC-1G-3/4	3 x 3/4	1	3	10

Iberville FS and FD products

FDC boxes – 2 3/8 in. deep (cast aluminum)



	Cat. no.	Hub size (in.)	No. of gangs	No. of lugs	Std. ctn.
	CIFDC-1/2	2 x 1/2	1	2	10
	CIFDC-3/4	2 x 3/4	1	2	5
	CIFDC-1	2 x 1	1	2	5

FST box – 3 3/8 in. deep (cast aluminum)



	Cat. no.	Hub size (in.)	No. of gangs	No. of lugs	Std. ctn.
	CIFST (2 faces)	2	-	-	10

FSF box – 3 in. deep (cast aluminum)



	Cat. no.	Hub size (in.)	No. of gangs	No. of lugs	Std. ctn.
	CIFSF (1 face)	2	-	-	10

Mounting lugs for CIFSU



	Cat. no.	Description	Std. ctn.
	FG-09080	Mounting lugs for a 3-hole universal FSU box. 2 3/8 inches deep.	10

Iberville FS and FD products

FS boxes – 1 1/8 in. deep (cast aluminum)



Cat. no.	Hub size	A	B	C	D	E	F	G	H	CI
CIFS-1G-1/2	1 x 1/2	4 5/16	2 13/16	1 3/16	1 7/8	1 1/4	2 7/8	2 5/16	1 5/16	14.0
CIFS-1G-3/4	1 x 3/4	4 5/16	2 13/16	1 3/16	1 7/8	1 1/2	2 7/8	2 5/16	1 5/16	14.0
CIFS-1G-1	1 x 1	4 5/16	2 13/16	1 3/16	1 7/8	1 3/4	2 7/8	2 5/16	1 5/16	14.0
CIFS-2G-1/2	1 x 1/2	4 3/8	4 11/16	7/8	1 7/8	1 1/4	2 7/8	4 1/4	1 5/8	26.0
CIFS-2G-3/4	1 x 3/4	4 3/8	4 11/16	7/8	1 7/8	1 9/16	2 7/8	4 1/4	1 5/8	26.0
CIFS-2G-1	1 x 1	4 3/8	4 11/16	7/8	1 7/8	1 3/4	2 7/8	4 1/4	1 5/8	26.0
CIFS-3G-1/2	1 x 1/2	4 3/8	6 1/2	7/8	1 7/8	1 1/4	2 7/8	6 1/16	1 5/8	41.0
CIFS-3G-3/4	1 x 3/4	4 3/8	6 1/2	7/8	1 7/8	1 9/16	2 7/8	6 1/16	1 5/8	41.0

Diagrams

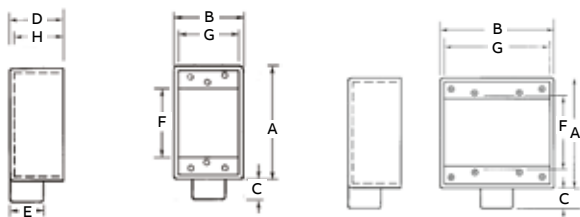

CIFS-1G

CIFS-2G

FSC boxes – 1 1/8 in. deep (cast aluminum)



Cat. no.	Hub size	A	B	C	D	E	F	G	H	CI
CIFSC-1G-1/2	2 x 1/2	4 5/16	2 13/16	2 7/32	1 7/8	1 1/4	2 7/8	2 5/16	1 5/16	14.0
CIFSC-1G-3/4	2 x 3/4	4 5/16	2 13/16	2 7/32	1 7/8	1 1/2	2 7/8	2 5/16	1 5/16	14.0
CIFSC-1G-1	2 x 1	4 5/16	2 13/16	2 7/32	1 7/8	1 3/4	2 7/8	2 5/16	1 5/16	14.0
CIFSC-2G-1/2	2 x 1/2	4 3/8	4 11/16	3 1/32	1 7/8	1 1/4	2 7/8	4 1/4	1 5/8	26.0
CIFSC-2G-3/4	2 x 3/4	4 3/8	4 11/16	3 1/32	1 7/8	1 9/16	2 7/8	4 1/4	1 5/8	26.0
CIFSC-2G-1	2 x 1	4 3/8	4 11/16	3 1/32	1 7/8	1 3/4	2 7/8	4 1/4	1 5/8	26.0
CIFSC-3G-3/4	2 x 3/4	4 3/8	6 1/2	2 9/32	1 7/8	1 9/16	2 7/8	6 1/8	1 5/8	41.0

Diagrams

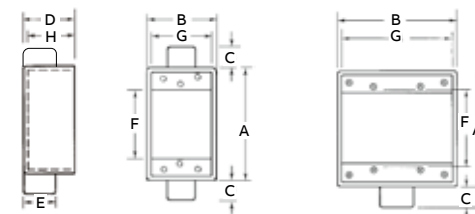

CIFSC-1G

CIFSC-3G-3/4

FSCC boxes – 1 1/8 in. deep (cast aluminum)



Cat. no.	Hub size	A	B	C	D	E	F	G	H	J	CI
CIFSCC-1G-1/2	3 x 1/2	4 5/16	2 13/16	2 7/32	1 7/8	1 1/4	2 7/8	2 5/16	1 5/16	1 1/16	14.0
CIFSCC-1G-3/4	3 x 3/4	4 5/16	2 13/16	2 7/32	1 7/8	1 1/2	2 7/8	2 5/16	1 5/16	1 3/4	14.0

Diagrams

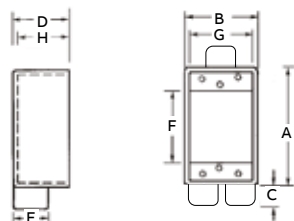

CIFSCC-1G

Iberville FS and FD products

— **FDC boxes – 2½ in. deep (cast aluminum)** 

Cat. no.	Hub size	A	B	C	D	E	F	G	H	CI
CIFDC-1/2	2 x ½	4 ⁵ / ₁₆	2 ¹³ / ₁₆	1 ⁵ / ₁₆	2 ⁵ / ₈	1 ³ / ₈	2 ⁷ / ₈	2 ³ / ₈	2 ⁵ / ₃₂	22.5
CIFDC-3/4	2 x ¾	4 ⁵ / ₁₆	2 ¹³ / ₁₆	1 ⁵ / ₁₆	2 ⁵ / ₈	1 ³ / ₈	2 ⁷ / ₈	2 ³ / ₈	2 ¹³ / ₃₂	22.5
CIFDC-1	2 x 1	4 ⁵ / ₁₆	2 ¹³ / ₁₆	1 ³ / ₈	2 ⁵ / ₈	1 ³ / ₈	2 ⁷ / ₈	2 ³ / ₈	2 ¹³ / ₃₂	22.5

Diagrams

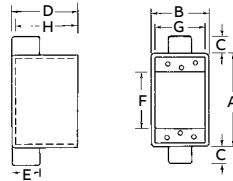

CIFDC-1/2

— **FSF box – 3 in. deep (cast aluminum)** 

Cat. no.	Hub size	A	B	C	D	E	F	G	H	J	CI
CIFSF	2	4 ⁵ / ₁₆	2 ³ / ₄	3 ¹ / ₂	2 ⁷ / ₈	2 ⁷ / ₈	2 ¹³ / ₁₆	2 ¹³ / ₁₆	1 ¹⁵ / ₃₂	–	30.5

Diagram

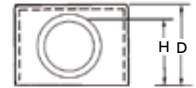

CIFSF (1 face)

— **FST box – 3½ in. deep (cast aluminum)** 

Cat. no.	Hub size	A	B	C	D	E	F	G	H	J	CI
CIFST	2	4 ⁵ / ₁₆	2 ³ / ₄	1 ³ / ₈	3 ³ / ₈	3	2 ⁷ / ₈	2 ⁵ / ₁₆	2 ¹³ / ₁₆	–	38.7

Diagram

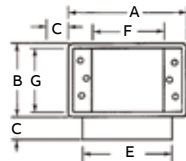

CIFST (2 faces)

Iberville FS and FD products

Single-gang blank covers (cast aluminum)



Cat. no.	Description	Std. ctn.
CIFS-100G	Blank – box mount (gasket glued on cover)	25



Single-gang switch covers (cast aluminum)



Cat. no.	Description	Std. ctn.
CFSTF	One lever switch – box mount	25



Single-gang switch covers (cast aluminum)



Cat. no.	A	B	F	G
CFSTF	$4\frac{3}{16}$	$2\frac{13}{16}$	$3\frac{1}{4}$	$1\frac{1}{8}$

Diagram

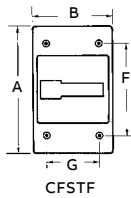

CFSTF

Red Dot Weatherproof products

FS and FD metallic covers

Single-gang horizontal covers (cast aluminum)

	Cat. no.	Description	Std. ctn.
	CCD-FS	Grey – box mount (zinc)	50

	CFSH-G	One GFCI receptacle – box mount	25
---	--------	---------------------------------	----

	CWPDR-FS	One duplex receptacle – box mount	25
---	----------	-----------------------------------	----

Single-gang horizontal covers (cast aluminum)

	Cat. no.	Description	Nominal size (in.)	Max. device face dia.	Std. ctn.
	CFSR-L	Single receptacle – box mount	1 ³ / ₁₆	1.600	25

*Gasket and screws included.

Single-gang (cast aluminum)

	Cat. no.	Description	Std. ctn.
	CFSB	Blank, box mount	100

Single-gang horizontal covers (cast aluminum)

Cat. no.	A	B	F	G	K	L
CCD-FS	2 ¹³ / ₁₆	4 ⁹ / ₁₆	1 ⁷ / ₈	3 ¹ / ₄	–	–
CFSH-G	2 ¹³ / ₁₆	4 ⁹ / ₁₆	1 ⁷ / ₈	3 ¹ / ₄	1 ¹¹ / ₃₂	2 ²¹ / ₃₂
CWPDR-FS	2 ¹³ / ₁₆	4 ⁹ / ₁₆	1 ⁷ / ₈	3 ¹ / ₄	–	–

Diagrams

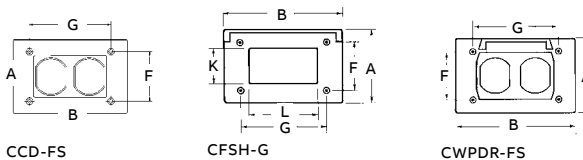

Single-gang vertical covers (cast aluminum)

	Cat. no.	Description	Std. ctn.
	CFSR-G	One GFCI receptacle – box mount	25

Red Dot Weatherproof products

FS and FD metallic covers

Single-gang vertical covers (cast aluminum)



Cat. no.	A	B	F	G	K	L
CFSR-G	4 ⁹ / ₁₆	2 ¹³ / ₁₆	3 ³ / ₄	1 ⁷ / ₈	2 ² / ₃₂	1 ¹¹ / ₃₂

Diagram

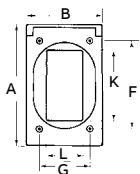

CFSR-G

Single-gang vertical covers (cast aluminum)



Cat. no.	A	B	F	G
CFSR-L	4 ⁹ / ₁₆	2 ¹³ / ₁₆	3 ³ / ₄	1 ⁷ / ₈

Diagram

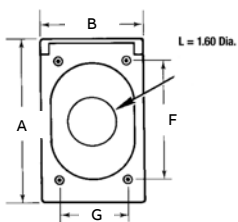

CFSR Series*

*Gasket and screws included.

Red Dot Weatherproof products

Deck grommet and stainless steel box and cover



—
Nonmetallic deck grommet

Cat. no.	Finish
DKG-CA	Black

All supplied receptacles are tamper-resistant



- 37.3 cu. in. capacity
- 316 stainless steel construction
- NEMA 3R rated
- NEMA 4X rated while not in use when properly installed
- NSF certified
- cULus Listed

—
Stainless steel while-in-use box and cover system



Cat. no.	Description	Std. ctn.
SSE	Stainless steel while-in-use box and cover system	1

Carlton Weatherproof fittings

Nonmetallic strain-relief multi-bushing fitting









Carlton indoor/outdoor nonmetallic strain-relief fittings are uniquely designed for high-performance reliability. Available for a variety of cables and applications. Carlton fittings make installations easier, faster and more secure... every time.

Features and benefits:

- Highly adaptable for use in indoor/outdoor, residential/commercial applications
 - Light arrays
 - Pools
 - AC/heat pump units
- Flexible elastomer bushings for a snug and secure fit on a variety of cable shapes and sizes
- NMWU cable compatible
- Unique overlapping compression fingers for an extra-strength grip around every bushing
- Hand-/plier-friendly gland nut for optimal ease-of-use
- Temperature rating to 85 °C
- Multiple trapezoidal nut threads for easy turning and added strength



	Cat. no.	Description	Trade size (in.)	Order quantity
	SRC-075	Nonmetallic unthreaded strain relief fitting	3/4	25 (min./mult.)
	SRTC-075	Nonmetallic threaded strain relief fitting	3/4	25 (min./mult.)
	SRTC-050	Nonmetallic threaded strain relief fitting	1/2	25 (min./mult.)

Bushing	NMD 90 cables (Loomex™-Romex™)	NMWU cables	Cord cable diameter range (in.)
	14/3	-	0.240-0.340
	12/3	14/3	0.340-0.450
	10/3	14/3	0.340-0.450
	8/3	12/3	0.450-0.590
	8/3	10/3	0.450-0.590
	14/2	14/2 and 12/2	-
	12/2	14/2 and 12/2	-
	10/2	14/2 and 12/2	-

Dry location boxes

347 volt FS box kits – 1½ in. deep (cast aluminum)



	Cat. no.	Hub size (in.)	No. of gangs	No. of lugs	Std. ctn.
CIFS-1G-1/2-HV	CIFS-1G-1/2-HV	1 x ½	1	3	5
CIFS-1G-3/4-HV	CIFS-1G-3/4-HV	1 x ¾	1	3	5



For dry location only

Includes stamped aluminum "CIFS-9HV" 347 V covers (not raintight)

347 volt FS box kits – 1½ in. deep (cast aluminum)



Cat. no.	Hub size	A	B	C	D	E	F	G	H	J	CI
CIFS-1G-1/2-HV	1 x ½	4 ¾	2 13/16	1 3/16	1 7/8	1 1/4	2 7/8	2 5/16	1 1/16	-	14.0
CIFS-1G-3/4-HV	1 x ¾	4 ¾	2 13/16	1 3/16	1 7/8	1 1/2	2 7/8	2 5/16	1 1/16	-	14.0

Diagrams

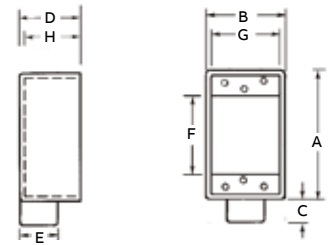

CIFS-1G-1/2-HV / CIFS-1G-3/4-HV

Includes stamped aluminum "CIFS-9HV" 347 V covers (not raintight)

Universal FSU boxes – 2 ¾ in. deep (cast aluminum)



	Cat. no.	Hub size (in.)	No. of gangs	No. of lugs	Std. ctn.
CIFSU	CIFSU-1/2	2 x ½	1	2	20
	CIFSU-3/4	2 x ¾	1	2	20



For dry location only

Supplied with close up plugs.

Universal FSU boxes – 2 ¾ in. deep (cast aluminum)



Cat. no.	Hub size	A	B	C	D	E	F	G	H	K	CI
CIFSU-1/2	2 x ½	4 5/16	2 ¾	1 3/16	2 7/8	1 7/8	2 13/16	2 1/2	1 29/32	7/16	18.5
CIFSU-3/4	2 x ¾	4 5/16	2 ¾	1 3/16	2 7/8	1 7/8	2 13/16	2 1/2	2	7/16	18.5

Diagrams

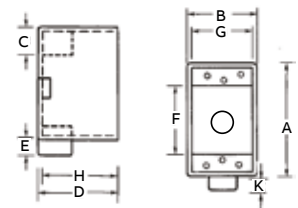

CIFSU

Supplied with close up plugs.

Dry location covers

Two-gang

	Cat. no.	Description	Std. ctn.
2CCB	2CCB*	Grey – device mount (grey paint)	50



*cULus

Three-gang

	Cat. no.	Description	Std. ctn.
3CCB	3CCB*	Blank cover, three gang device mount	25



Covers are approved for dry locations only
*cULus

Single-gang FS covers (stamped aluminum)



	Cat. no.	Description	Std. ctn.
CIFS-4	CIFS-4	Blank – single gang – box mount	25



CIFS-7 / CIFS-5	CIFS-5	15 A single receptacle – box mount	25
	CIFS-7	20 A single locking receptacle – box mount	25



CIFS-6	CIFS-6	One duplex receptacle – box mount	25
--------	--------	-----------------------------------	----



CIFS-8	CIFS-8	Single gang - Decora - box mount	25
--------	--------	----------------------------------	----



CIFS-9	CIFS-9	One toggle switch – box mount	25
--------	--------	-------------------------------	----



CIFS-9-HV	CIFS-9-HV	One toggle switch (347 V) – box mount	50
-----------	-----------	---------------------------------------	----



Two-gang (cast aluminum)

Cat. no.	A	B	F	G	K
2CCB	4 ⁹ / ₁₆	4 ⁵ / ₈	3 ⁹ / ₃₂	1 ¹³ / ₁₆	–

Diagram

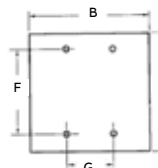

Three-gang (stamped aluminum)

Cat. no.	A	B	F	G
3CCB	4 ¹ / ₂	6 ³ / ₈	3 ¹ / ₄	5 ⁵ / ₈

Diagram

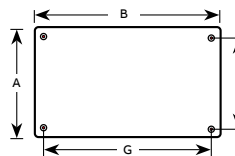

Covers are approved for dry locations only

Single-gang FS covers (stamped aluminum)



Cat. no.	A	B	F	G	K
CIFS-4	4 ⁹ / ₁₆	2 ³ / ₄	3 ¹ / ₄	1 ⁷ / ₈	–
CIFS-7	4 ⁹ / ₁₆	2 ³ / ₄	3 ¹ / ₄	1 ⁷ / ₈	1 ¹⁹ / ₃₂
CIFS-5	4 ⁹ / ₁₆	2 ³ / ₄	3 ¹ / ₄	1 ⁷ / ₈	1 ¹³ / ₃₂
CIFS-6	4 ⁹ / ₁₆	2 ³ / ₄	3 ¹ / ₄	1 ⁷ / ₈	–
CIFS-8	4 ⁹ / ₁₆	2 ³ / ₄	3 ¹ / ₄	1 ⁷ / ₈	–
CIFS-9	4 ⁹ / ₁₆	2 ³ / ₄	3 ¹ / ₄	1 ⁷ / ₈	–
CIFS-9-HV	4 ⁹ / ₁₆	2 ³ / ₄	3 ¹ / ₄	1 ⁷ / ₈	–

Diagrams

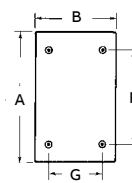

CIFS-4

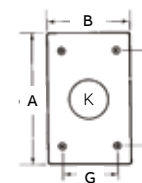

CIFS-7 / CIFS-5

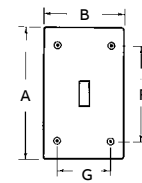

CIFS-9 / CIFS-9-HV

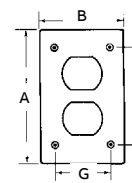



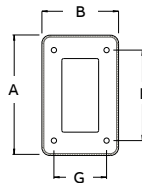



CIFS-6







CIFS-8

Dry location covers

Two-gang FS covers (stamped aluminum) 

Cat. no.	Description	Std. ctn.
CIFS-42	Blank – two gang – box mount	20
		
CIFS-62	Two duplex receptacles – box mount	20
		
CIFS-69	One duplex receptacles, one toggle switch – box mount	20
		
CIFS-82	Two gang - Decora - box mount	20
		
CIFS-92	Two toggle switches – box mount	20
		

Three-gang FS covers (stamped aluminum) 

Cat. no.	Description	Std. ctn.
CIFS-43	Blank – three gang – box mount	10
		
CIFS-63	Three gang – duplex receptacles – box mount	10
		
CIFS-83	Three gang – Decora – box mount	10
		
CIFS-93	Three gang - toggle switches – box mount	10
		

Two-gang FS covers* (stamped aluminum) 

Cat. no.	A	B	F	G
CIFS-42*	4 ⁵ / ₁₆	4 ⁵ / ₁₆	3 ¹ / ₄	3 ²³ / ₃₂
CIFS-62*	4 ⁵ / ₁₆	4 ⁵ / ₁₆	3 ¹ / ₄	3 ²³ / ₃₂
CIFS-69*	4 ⁵ / ₁₆	4 ⁵ / ₁₆	3 ¹ / ₄	3 ²³ / ₃₂
CIFS-82*	4 ⁵ / ₁₆	4 ⁵ / ₁₆	3 ¹ / ₄	3 ²³ / ₃₂
CIFS-92*	4 ⁵ / ₁₆	4 ⁵ / ₁₆	3 ¹ / ₄	3 ²³ / ₃₂

Diagrams

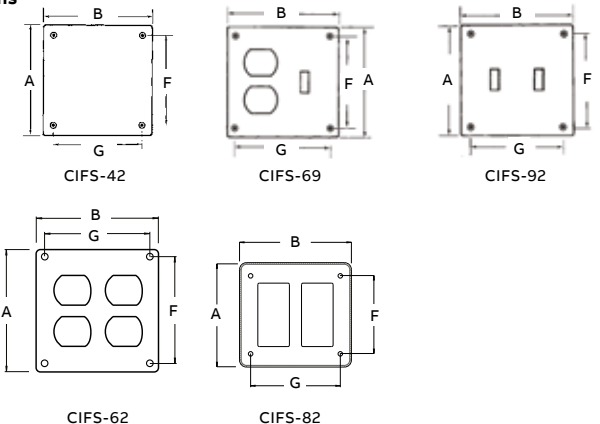

The diagrams show the physical layout of the covers with dimension lines. CIFS-42 is a blank cover with four mounting holes. CIFS-69 has one duplex receptacle and one toggle switch. CIFS-92 has two toggle switches. CIFS-62 and CIFS-82 have two duplex receptacles. Dimensions A, B, F, and G are indicated for each cover.

* CIFS covers are CSA approved only

Three-gang FS covers* (stamped aluminum) 

Cat. no.	A	B	F	G	K
CIFS-43	4 ⁵ / ₁₆	6 ⁷ / ₁₆	3 ¹ / ₄	5 ⁵ / ₈	–
CIFS-63	4 ⁵ / ₁₆	6 ⁷ / ₁₆	3 ¹ / ₄	5 ⁵ / ₈	–
CIFS-83	4 ⁵ / ₁₆	6 ⁷ / ₁₆	3 ¹ / ₄	5 ⁵ / ₈	–
CIFS-93	4 ⁵ / ₁₆	6 ⁷ / ₁₆	3 ¹ / ₄	5 ⁵ / ₈	–

Diagrams

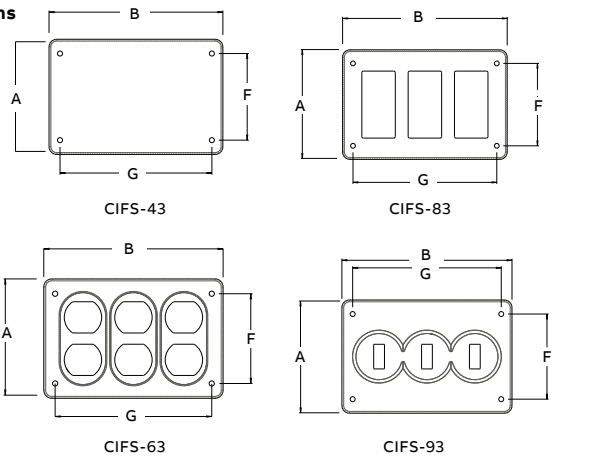

The diagrams show the physical layout of the covers with dimension lines. CIFS-43 is a blank cover with six mounting holes. CIFS-83 has three Decora-style receptacles. CIFS-63 and CIFS-93 have three duplex receptacles. Dimensions A, B, F, G, and K are indicated for each cover.

Cross reference

Cat. no.	Description	Taymac/Hubbell/ Bell catalog number	RAB	EATON Crouse- Hinds Cooper Industries	Intermatic
Single-gang cover – 2¼" internal depth (aluminum)					
CKSUV	Small vertical cover universal Code Keeper accommodates duplex, GFCI, single receptacle and toggle switch – lockable	MX4280SCN	–	–	WP3110MXD
Single-gang cover – 3¼" internal depth (aluminum)					
CKMU	Medium horizontal cover universal Code Keeper accommodates duplex, GFCI, single receptacle and toggle switch – lockable	MX3300CN/MX4380SCN	–	–	WP1010HMXD
CKMUV	Medium vertical cover universal Code Keeper accommodates duplex, GFCI, single receptacle and toggle switch – lockable	MX3200CN/MX4280SCN	–	–	WP1010MXD
Two-gang cover – 4¼" internal depth (aluminum)					
2CKU	Regular cover universal code keeper accommodates various configurations – lockable	MX6200CN/ MX7280SCN	–	–	WP1250MXD
CKPS-C-CN	Single-gang shallow – vertical or horizontal	–	–	TP7495 1 GANG	WP3100C/ WP3103C/ WP5000C
CKPS-G-CN	Single-gang shallow – vertical or horizontal	ML450GCN/ ML500G	–	TP7488	WP5000G
CKPS-W-CN	Single-gang shallow – vertical or horizontal	ML450WCN/ ML500W	–	TP7488W	WP5000W
CKPS-BR-CN	Single-gang shallow – vertical or horizontal	ML450ZCN/ ML500Z	–	–	WP5000BR
CKPM-C-CN	Single-gang medium – vertical or horizontal	MM420C/ MM410CACN	–	TP7490	WP1110C/ WP5110C
CKPM-G-CN	Single-gang medium – vertical or horizontal	MM420G/ MM410GCN	–	TP7491	WP1110GC/ WP5110G
CKPM-W-CN	Single-gang medium – vertical or horizontal	MM420W/ MM420W	–	TP7491W	WP1110WC/ WP5110W
CKPM-BR-CN	Single-gang medium – vertical or horizontal	MM410WCN	–	–	WP5110BR
CKPL-C-CN	Single-gang large – vertical or horizontal	MM710CCN/ MM720C	–	–	WP1150C
2CKPM-C-CN	Two-gang medium	MM2410CCN/ MM2420C	–	TP7495 2 GANG	WP1020C/ WP5225C
2CKPM-G-CN	Two-gang medium	MM2410GCN/ MM2420G	–	TP7489	WP1020GC/ WP5225G
2CKPM-W-CN	Two-gang medium	–	–	TP7489W	WP1020WC/ WP5225W
2CKPM-BR-CN	Two-gang medium	–	–	–	WP5225BR
2CKPL-C-CN	Two-gang large	MM7440CCN	–	–	WP1050
FS boxes – 1½" deep (cast aluminum)					
CIFS-1G-1/2	1 x ½	FS-1	–	FSM1	–
CIFS-1G-3/4	1 x ¾	FS-2	–	FSM2	–
CIFS-1G-1	1 x 1	FS-3	–	FSM3	–
CIFS-2G-1/2	1 x ½	2FS-1	–	FS12	–
CIFS-2G-3/4	1 x ¾	2FS-2	–	FS22	–
CIFS-2G-1	1 x 1	2FS-3	–	FS32	–
CIFS-3G-1/2	1 x ½	3FS-P1	–	–	–
CIFS-3G-3/4	1 x ¾	3FS-P2	–	FS23	–

Cross reference

Cat. no.	Description	Taymac/Hubbell/ Bell catalog number	EATON Crouse-Hinds		
			RAB	Cooper Industries	Intermatic
347 Volt FS box kits – 1$\frac{1}{8}$" deep (cast aluminum)					
CIFS-1G-1/2-HV	1 x $\frac{1}{2}$	-	-	-	-
CIFS-1G-3/4-HV	1 x $\frac{3}{4}$	-	-	-	-
FS boxes – 1$\frac{1}{8}$" deep (cast aluminum)					
CIFSC-1G-1/2	2 x $\frac{1}{2}$	FSC-1	-	FSCM1	-
CIFSC-1G-3/4	2 x $\frac{3}{4}$	FSC-2	-	FSCM2	-
CIFSC-1G-1	2 x 1	FSC-3	-	FSCM3	-
CIFSC-2G-1/2	2 x $\frac{1}{2}$	2FSC-1	-	FSC12	-
CIFSC-2G-3/4	2 x $\frac{3}{4}$	2FSC-2	-	FSC222	-
CIFSC-2G-1	2 x 1	-	-	FSC32	-
CIFSC-3G-3/4	2 x $\frac{3}{4}$	-	-	-	-
FSCC boxes – 1$\frac{1}{8}$" deep (cast aluminum)					
CIFSCC-1G-1/2	3 x $\frac{1}{2}$	FSCC-1	-	-	-
CIFSCC-1G-3/4	3 x $\frac{3}{4}$	FSCC-2	-	-	-
FDC boxes – 2$\frac{1}{8}$" deep (cast aluminum)					
CIFDC-1/2	2 x $\frac{1}{2}$	FDC-1	-	FDM1	-
CIFDC-3/4	2 x $\frac{3}{4}$	FDC-2	-	FDM2	-
CIFDC-1	2 x 1	FDC-3	-	FDM3	-
Universal FSU boxes – 2$\frac{1}{8}$" deep (cast aluminum)					
CIFSU-1/2	2 x $\frac{1}{2}$	-	-	-	-
CIFSU-3/4	2 x $\frac{3}{4}$	-	-	-	-
FSF box – 3" deep (cast aluminum)					
CIFSF	2	-	-	-	-
FST box – 3$\frac{1}{8}$" deep (cast aluminum)					
CIFST	2	-	-	-	-
Single-gang horizontal covers (cast aluminum)					
CCD-FS	Grey – box mount (zinc)	5094-0	C01	TP7206	-
CFSH-G	One GFCI receptacle – box mount	5102-0	-	TP7236	-
CWPDR-FS	One duplex receptacle – box mount	5094-0	-	TP7232	-
Single-gang vertical covers (cast aluminum)					
CFSR-G	One GFCI receptacle – box mount	5104-0	-	TP7240	-
CWPV-G	One GFCI receptacle – device mount	5104-0	-	TP7240	-
Single-gang switch covers (cast aluminum)					
CFSTF	One lever switch – box mount	FZ8648	-	-	-
Single-gang blank covers (cast aluminum)					
CCB	Grey – device mount (stamped aluminum)	5173-0/ 1FBC	FS-C	TP7292	-
CCB-FS	Grey – box mount (stamped aluminum)	5174-0/ FSBC	-	FBCM1/FBCA1	-
CFSB	Blank – box mount	5174-0/ FSBC	-	FBCM1/FBCA1	-
CIFS-100G	Blank – box mount (gasket glued on cover)	-	-	FBCM1/FBCA1	-
Single-gang vertical covers (cast aluminum)					
CFSR-L	Single receptacle – box mount	FCLG	-	TP7214	-

Cross reference

Cat. no.	Description	Taymac/Hubbell/ Bell catalog number	RAB	EATON Crouse-Hinds Cooper Industries	Intermatic
Two-gang (cast aluminum)					
2CCB	Grey – device mount (stamped aluminum)	5175-0/2FBC	FS-2C	S1002G SA	–
Single-gang FS covers (stamped aluminum)					
CIFS-4	Blank – single gang – box mount	FSBC	–	FBCS1	–
CIFS-5	15 A single receptacle – box mount	–	–	–	–
CIFS-6	One duplex receptacle – box mount	1FAC	–	RCM1	–
CIFS-7	20 A single locking receptacle – box mount	–	–	–	–
CIFS-8	Single gang - Decora - box mount	–	–	–	–
CIFS-9	One toggle switch – box mount	1FTC	–	SWCS1	–
CIFS-9-HV	One toggle switch (347 V) – box mount	–	–	–	–
Two-gang FS covers* (stamped aluminum)					
CIFS-42	Blank – two gang – box mount	2FBC	FS-2C	S1002G SA	–
CIFS-62	Two duplex receptacles – box mount	2FAC	X	S232	–
CIFS-69	One duplex receptacles, one toggle switch – box mount	2FTAC	X	S32232	–
CIFS-82	2 gang - Decora - box mount	–	–	–	–
CIFS-92	Two toggle switches – box mount	2FTC	X	S32232	–
Three-gang FS covers* (stamped aluminum)					
CIFS-43	Blank – three gang – box mount	–	–	–	–
CIFS-63	Three gang – duplex receptacles – box mount	–	–	–	–
CIFS-83	Three gang – Decora – box mount	–	–	–	–
CIFS-93	Three gang - toggle switches – box mount	–	–	–	–
Weatherproof junction box kits (cast aluminum)					
CIC-8444	4 x ½	–	1/2DVXJ/C	TP7146	–
CIC-8446	4 x ¾	–	3/4DVXJ/C	TP7150	–
CIC-8448	4 x 1	–	–	–	–
Outlet box 4½ dia. (cast aluminum)					
CIC-8495	6 x ½	–	–	–	–
Weatherproof round cover – 4¾" dia. (stamped aluminum)					
CIC-93	For 4 " weatherproof round box Includes gasket and mounting screws	5653-1	XCS	TP7158	–
Outlet covers – 4⅞" dia. (cast aluminum)					
S211E	Round standard lamp holder cover, grey, aluminum,	5193-0	DC100	TP7300	–
S-12	Round standard lamp holder cover, grey, aluminum	–	–	–	–
S-213E-R		5197-0	CR-3	TP7308	–
Single-gang outlet boxes – 2" deep (cast aluminum)					
S100CN	Single-gang universal standard outlet box	5320-0	D5613	TP7010	–
S100BRCN	Single-gang universal standard outlet box, bronze, aluminum	5320-2	–	TP7012	–
S100WHCN	Single-gang universal standard outlet box, white, aluminum	5320-6	–	TP7011	–
S105CN	Single-gang universal weatherproof box, grey, aluminum	5320-0	D5633	TP7018	–
B1303OG	Single-gang universal weatherproof box, grey, aluminum	–	–	–	–
IH3-1-LM	Single-gang universal weatherproof box, grey, aluminum	5320-0/ 5320-9	D5613	TP7010	–

Cross reference

Cat. no.	Description	Taymac/Hubbell/ Bell catalog number	RAB	EATON Crouse- Hinds Cooper Industries	Intermatic
IH4-1-LM	Single-gang universal weatherproof box, grey, aluminum	5321-0	D5614	TP7026	-
IH4-2-LM	Single-gang universal weatherproof box, grey, aluminum	5330-0	D5634	TP7034	-
S101E	Single-gang universal standard outlet box, grey, aluminum	5321-0	D5614	TP7026	-
S102CN	Single-gang universal standard outlet box, grey, aluminum	5322-0	D5616/D5615	TP7042	-
S107CN	Single-gang universal weatherproof box, grey, aluminum	5331-0	D5635	TP7050	-
B1501SGR	Single-gang universal weatherproof box, grey, aluminum	5323-0	D5616/D5615	TP7042	-
B1502SG	Single-gang universal weatherproof box, hub, grey, aluminum	5332-0	D5635	TP7052	-
DIH3-1-LM	Single-gang universal weatherproof box, grey, aluminum	5320-0/ 5320-5	DDB23P	TP7010	-
DIH3-1-LM-WH	Single-gang universal weatherproof box, white, aluminum	5320-1/ 5320-6	-	TP7011	-
DIH3-2-LM	Single-gang universal weatherproof box, white, aluminum	5324-0	-	TP7011	-
IH3-1	Single-gang universal weatherproof box, white, aluminum	5320-1/ 5320-6	-	TP7011	-
IH4-1	Single-gang universal weatherproof box, white, aluminum	5321-1/ 5321-6	-	-	-
IH4-2	Single-gang universal weatherproof box, white, aluminum	-	-	-	-
IH5-1-LM	Single-gang universal weatherproof box, white, aluminum	5322-0	-	-	-
IH5-2-LM	Single-gang universal weatherproof box, white, aluminum	5331-0/ 5332-0	-	-	-
Single-gang outlet boxes – 2$\frac{5}{8}$" deep (cast aluminum)					
IHD3-1	Single-gang deep universal weatherproof box, 2 $\frac{5}{8}$ " deep, grey, aluminum	5385-0	DDB23P	TP7074	-
IHD31GDC	Single-gang deep universal weatherproof box, 2 $\frac{5}{8}$ " deep, grey, aluminum	5385-0	DDB23P	TP7074	-
IHD3-2	Single-gang deep universal weatherproof box, 2 $\frac{5}{8}$ " deep, grey, aluminum	5386-0	DDB33P	TP7078	-
IHD3-3	Single-gang deep universal weatherproof box, 2 $\frac{5}{8}$ " deep, grey, aluminum	5387-0	-	TP7082	-
IHD4-1	Single-gang deep universal weatherproof box, 2 $\frac{5}{8}$ " deep, grey, aluminum	-	-	-	-
IHD4-2	Single-gang deep universal weatherproof box, 2 $\frac{5}{8}$ " deep, grey, aluminum	-	-	-	-
Two-gang outlet boxes – 2" deep (cast aluminum)					
S400CN	Two-gang universal weatherproof box, grey, aluminum, with ground screw	5333-0	D5313	TP7086	-
2IH3-2	Two-gang universal weatherproof box, grey, aluminum, with ground screw	5341-0	D5333	TP7090	-
2IH4-1	Two-gang universal weatherproof box, grey, aluminum, with ground screw	5335-0	-	TP7094	-
2IH4-2	Two-gang universal weatherproof box, grey, aluminum, with ground screw	5343-0	-	TP7098	-
S401CN	Two-gang universal weatherproof box, grey, aluminum, with ground screw	5337-0	D5317	TP7102	-
S402CN	Two-gang universal weatherproof box, grey, aluminum, with ground screw	5342-0	-	TP7106	-
2IH5-1	Two-gang universal weatherproof box, grey, aluminum, with ground screw	5337-0	-	TP7102	-
2IH5S2-1	Two-gang universal weatherproof box, grey, aluminum, with ground screw	5334-0	-	TP7102	-

Cross reference

Cat. no.	Description	Taymac/ Hubbell/Bell catalog number	RAB	EATON Crouse- Hinds Cooper Industries	Intermatic
2IH5S2-2	Two-gang universal weatherproof box, grey, aluminum, with ground screw	5342-0	–	TP7106	–
2IH7-1	Two-gang universal weatherproof box, grey, aluminum, with ground screw	5340-0	D5317	TP7110	–
2IH7-2	Two-gang universal weatherproof box, grey, aluminum, with ground screw	5348-0	D5337	TP7114	–
2IH7S2-1	Two-gang universal weatherproof box, grey, aluminum, with ground screw	5338-0	D5317	TP7110	–
2IH7S2-2	Two-gang universal weatherproof box, grey, aluminum, with ground screw	5346-0	D5337	TP7114	–
Two-gang outlet boxes – 2½" deep (cast aluminum)					
2IHD5-1	(5) ½" hubs	–	DDB252P/ DB252P	TP7126	–
2IHD5-2	(5) ¾" hubs	5388-0	–	TP7130	–
2IHD5-3	(5) 1" hubs	5389-0	–	TP7134	–
Three-gang outlet boxes – 2½" deep (cast aluminum)					
B37D20G	7 ¾"	5390-0	DDB373	TP7143	–
B37D30G	7 1"	–	–	TP7144	–
Single-gang extensions ring (cast aluminum)					
IHE	Single-gang universal box extension adapter, 1" deep, with gasket and screws	5406-0	DXR-1	TP7120	–
S121E-R-CN	Single-gang universal box extension adapter, 1¾" deep, with gasket, screws and ground screws	–	–	TP7173	–
IHEF6S2-1	Single-gang flanged extension adapter, 1⅞" deep, with gasket and screws	5414-0	–	–	–
IHEF6S2-2	Single-gang flanged extension adapter, 1⅞" deep, with gasket and screws	5415-0	–	–	–
Two-gang extensions ring (cast aluminum)					
2IHE	Two-gang universal box extension ring, grey, aluminum, gaskets and screws include	5407-0	DXR-2	TP7123	–
Single-gang device mount covers – horizontal (zinc)					
S310BRE	For duplex receptacle – bronze	5180-2	–	TP7209	–
S310E-R	For duplex receptacle – grey	5180-0	CO1	TP7207	–
S310WHE	For duplex receptacle – white	5180-1	–	TP7208	–
S305BRE	For GFCI receptacle – bronze	5101-2	–	TP7238	–
S305E	For GFCI receptacle – grey	5101-5	GFI-H	TP7236	–
S305WHE	For GFCI receptacle – white	5101-6	–	TP7237	–
CCG	GFCI receptacle box cover	5101-0	–	TP7240	–
CCS	For single receptacle, horizontal	5152-0	–	TP7214	–
DCCG-BR	GFCI receptacle, horizontal – bronze	5101-2	–	TP7238	–
DCCG-WH	GFCI receptacle, horizontal – white	5101-1	–	TP7237	–

Cross reference

Cat. no.	Description	Taymac/ Hubbell/Bell catalog number	RAB	EATON Crouse- Hinds Cooper Industries	Intermatic
Single-gang device mount covers – vertical (zinc)					
S306BRE	For GFCI receptacle – bronze	5301-2	–	TP7242	–
S306E	For GFCI receptacle – grey	5103-5	GFI-V	TP7240	–
S306WHE	For GFCI receptacle – white	5103-6	–	TP7241	–
CCGV	GFCI Receptacle Box Cover – grey	5103-0	–	TP7240	–
CCGV-L	For GFCI receptacle with lock option	–	–	–	–
CCSV	For single receptacle	5155-0	–	TP7202	–
Single-gang device mount cover – horizontal and vertical (zinc)					
DCCU	Flip-lid cover – for GFCI, single, duplex or switch configuration supplied with 2 adapters and 2 screws, lockable – grey	MX1050S	–	TP7214	–
DCCU-BR	Flip-lid cover – for GFCI, single, duplex or switch configuration supplied with 2 adapters and 2 screws, lockable – bronze	MX1050Z	–	–	–
DCCU-WH	Flip-lid cover – for GFCI, single, duplex or switch configuration supplied with 2 adapters and 2 screws, lockable – white	MX1050W	–	–	–
Single-gang device mount covers					
S340E-R	Blank cover (painted steel) – grey	5173-0	FS-C	TP7292	–
S340BRE-R-CN	Blank cover (painted steel) – bronze	5173-2/ 5173-7	–	TP7294	–
S340WHE-R-CN	Blank cover (painted steel) – white	5173-6/ 5173-1	–	TP7293	–
Single-gang device mount covers (zinc)					
CCPO	Power outlet cover for 30 A and 50 A receptacles box mount	–	–	TP7218	–
S321E	For switch packed with spacers	–	–	TP7256	–
CCT	Switch receptacle cover	–	–	TP7256	–
CCT-1	Switch cover with single pole switch 15 A, 125 V AC	5121-0	–	TP7260	–
CCT-1-20	Switch cover with single pole 20A switch, 120 V, 277 V AC	5128-0	–	–	–
SW1	Switch box cover with lever switch. Single pole. 10 A 125 V	–	–	–	–
Lampholder rectangular covers (zinc)					
S201E	One ½" tapped hole, grey	5186-0	–	TP7312	–
S203E-R	Three ½" tapped holes, grey	5189-0	R14-3	TP7320	–
S203BRE	Three ½" tapped holes, bronze	5189-2	R14-3-R	TP7322	–
S203WHE	Three ½" tapped holes, white	5189-1	R14-3-W	TP7321	–

Cross reference

Cat. no.	Description	Taymac/ Hubbell/Bell catalog number	RAB	EATON Crouse- Hinds Cooper Industries	Intermatic
Two-gang device mount covers (zinc)					
S410E	For two duplex receptacles	5148-0	-	TP7222	-
2CCD	2-duplex receptacle box cover	5148-0	-	TP7228	-
2CCS	For two single receptacles	5157-0	-	TP7220	-
2CCT	Switch receptacle cover	5125-0	-	TP7268	-
2CCTD	Switch and one duplex receptacle cover	-	-	-	-
2CCDG	One duplex and one GFCI receptacle	5133-0	-	TP7248	-
2CCG	GFCI receptacle box cover-horizontal	5145-0	-	TP7252	-
R104	Two-gang gasket	5020-0	-	GASK434	-
Two- and three-gang device mount covers (zinc)					
S413E	For two GFCI receptacles	5145-0	-	TP7252	-
Two- and three-gang device mount covers (stamped aluminum)					
S440E-R	Blank cover, two gang (stamped aluminum) – grey	5175-0	FS-2C	TP7296	-
3CCB	Blank cover, three gang	5177-0	-	-	-
Two-gang covers (zinc)					
2CCU	Flip-lid cover for GFCI, duplex or single switch configurations supplied with 4 adapters and 4 screws lockable (lock not included)	MX2050S	-	TP7252	-
Outlet boxes – 4½" dia. (cast aluminum)					
S110CN	Round outlet box, 17 cu. in., grey, aluminum, with ground screws	5361-0	1/2DVXJ/LC	TP7146	-
S110BRCN	Single-gang universal standard outlet box, 17.3 cu. in., bronze, aluminum, with ground screws	5361-2	-	TP7149	-
S110WHCN	Single-gang universal standard outlet box, 17.3 cu. in., white, aluminum, with ground screws	5361-1	-	TP7148	-
DS-47-BR	Round outlet box, 17 cu. in., bronze, aluminum	5361-2	-	-	-
DS-47-WH	Round outlet box, 17 cu. in., white, aluminum	5361-1	-	-	-
S-48	Round outlet box, 16 cu. in., grey, aluminum	5372-0	3/4DVXJ/LC	TP7158	-
S-47	Round outlet box, 17 cu. in., grey, aluminum	5361-0	1/2DVXJ/LC	-	-
Outlet box extension – 4½" dia. (cast aluminum)					
SE-48	Round extension ring, grey, aluminum, gaskets and screws	-	-	TP7152	-
S130E-CN	Round extension adapter, grey, aluminum, with ground screws	5363-0	-	TP7152	-

Cross reference

Cat. no.	Description	Taymac/Hubbell/ Bell catalog number	RAB	EATON Crouse- Hinds Cooper Industries	Intermatic
Outlet box kits – 4¹/₈" dia. (cast aluminum)					
DS-47B	Round outlet box, grey, aluminum, blank cover	–	1/2DVXJC/C - DC100	TP7147	–
S47CFB	Ceiling fan outlet box, grey, aluminum	–	1/2DVXJC/C	–	–
DS-48B	Round outlet box, grey, aluminum, blank cover	5372-0	3/4DVXJC/C -DC100	TP7151	–
Spike light (zinc)					
SPK6-P-GR	Green	–	HRG-ST	–	–
SPK6-P-BK	Black	–	HRB-ST	–	–
SPK6-P-BR	Bronze	SL101B	–	–	–
Economy style – internal gasket (zinc)					
S500BREG-CN	Bronze	5606-2	LFP38-A	TP7165	–
S500EG-CN	Grey	5606-0	–	TP7163	–
S500WHEG-CN	White	5606-1	LFP38-W	TP7164	–
Double economy style lampholder with round cover (zinc)					
S513EG-CN	Grey	5625-0	HR-2	TP7330	–
S513BREG-CN	Bronze	5625-2	HRR-2	TP7332	–
S513WHEG-CN	White	5625-6	HRW-2	TP7331	–
Contemporary lampholder kits					
B228E-R	Grey	5876-5	R201	–	–
B228BRE-R	Bronze	5876-7	R201R	–	–
B228WHE-R	White	5876-6	R201W	–	–
Ceiling mount (5 holes)					
MCL150C	1	–	VX1F	TP7800	–
Wallmount (5 holes)					
MCL150W	1	–	VXBR1F	TP7820	–
Traditional 2-lamp round box kits					
S212G-CN	Grey	5876-5	R201	TP7330	–
S212BRG-CN	Bronze	5876-7	R201R	TP7332	–
Duplex weatherproof outlet device kits					
S312E-CN		5839-5	–	–	–
S312BRE-CN		5839-7	–	–	–
S312WHE-CN		5839-6	–	–	–
GFCI weatherproof outlet device kit					
S315E-CN		5874-5	–	–	–
S315WHE-CN		5874-6	–	–	–
GFCI weatherproof outlet device kit					
S355E-CN		5874-5	–	–	–
S355P-CN		–	–	–	–
Nonmetallic deck grommet					
DKG-CA		–	–	–	–

Cross reference

Cat. no.	Description	Taymac/ Hubbell/Bell catalog number	RAB	EATON Crouse- Hinds Cooper Industries	Intermatic
Weatherproof accessories – gaskets, plugs					
CCK		5019-0	–	–	–
R104		5020-0	–	–	–
S621E		5017-0	–	–	–
PLG-1-RD		5269-0	–	TP7940	–
PLG-2-RD		5270-0	–	TP7944	–
PLG-3-RD		5171-0	–	–	–
S603E-R		5269-5	–	TP7940	–
S603BRE-R		5269-7	–	TP7942	–
S603WHE-R		5269-6	–	–	–
Outlet covers – 4¹/₈" dia. (cast aluminum)					
S341E-R	Round blank weatherproof box cover, colour grey	–	XCS	TP7158	–
SS-B	Round blank weatherproof cover, grey, aluminum, with gasket and screws	–	XCS	TP7158	–
S211E	Round standard lamp holder cover, grey, aluminum,	5193-0	DC100	TP7300	–
S211BRE	Round standard lamp holder cover, bronze, aluminium	5193-2	DC100-R	TP7302	–
S211WHE	Round standard lamp holder cover, white, aluminium	5193-1	DC100-W	TP7301	–
S-12	Round standard lamp holder cover, grey, aluminum	5193-5	–	–	–
S213E-R	Round standard lamp holder cover, grey, aluminum, with gasket, screws and plugs	5197-0	DC103	TP7308	–
S213BRE	Round standard lamp holder cover, bronze, aluminum, with gasket, screws and plugs	5197-2	DC103-R	TP7310	–
S213WHE	Round standard lamp holder cover, white, aluminum, with gasket, screws and plugs	5197-1	DC103-W	TP7309	–
Type FSE nonmetallic					
FSEB-050	For dead-end terminations	–	–	–	–
FSEB-075		–	–	–	–
FSEB-100		–	–	–	–
Type FSS nonmetallic					
FSSB-050	For multiple dead-end circuit terminations or where additional support is required in stub-up applications	X	–	–	–
FSSB-075		X	–	–	–
FSSB-100		X	–	–	–
Type FSC nonmetallic					
FSCB-050	For through terminations	PBSB37550GY	–	–	–
FSCB-075		PBSB37550GY	–	–	–
FSCB-100		X	–	–	–
Type FSCC nonmetallic					
C979EFN		X	–	–	–
C979FFN		X	–	–	–
FSCB-050	For terminations where hub requirements vary according to application – hubs easily made with flared wood bit or hole saw	X	–	6080	–

Cross reference

Cat. no.	Description	Taymac/Hubbell/ Bell catalog number	RAB	EATON Crouse- Hinds Cooper Industries	Intermatic
Type FDC nonmetallic					
C9811EN	For terminations where hub requirements vary according to application – hubs easily made with flared wood bit or hole saw	X	–	–	–
C9811FN		X	–	–	–
Type FDE nonmetallic					
C9801DN	For dead-end terminations where large devices or additional wiring capacity is required	X	–	–	–
C9801EN	For dead-end terminations where large devices or additional wiring capacity is required	X	–	–	–
Type 2FSC nonmetallic					
FSCB2-050	For through terminations where two devices or additional wiring capacity is required	X	–	–	–
FSCB2-075		X	–	–	–
FSCB2-100		X	–	–	–
Type 2FSE nonmetallic					
FSEB2-50	For dead-end terminations where two devices or additional wiring capacity is required	X	–	–	–
FSEB2-75		X	–	–	–
FSEB2-100		X	–	–	–
Type FS nonmetallic					
CE9802	For terminations where hub requirements vary according to application - hubs easily made with flared wood bit or hole saw	X	–	–	–
Single-gang vertical covers (nonmetallic)					
WPCV-15A-G	For 15 A or other single receptacles under 1.375" dia.	X	–	–	–
WPCV-20A-G	For 20 A or other single receptacles under 1.625" dia.	X	–	–	–
E98G30N-CAR	For 30 A or other single receptacles under 1.750" dia.	X	–	–	–
Single-gang vertical covers (nonmetallic)					
WPCV-SSW-G	Single switch	X	–	–	–
WPCV-DUP-V-G	Duplex receptacle	X	–	–	–
WPCV-GFI-V-G	GFCI receptacle – device opening dimensions: 2 ⁵ / ₁₆ H x 1 ⁵ / ₁₆ W	X	–	S2966	–
Single-gang vertical covers (nonmetallic)					
WPCV-TOG-G	Toggle switch	PTC100GY	–	S2983	–
WPCV-BLK-G	Supplied with stainless steel mounting screws and gasket	PBC100GY	–	–	–
WPCV-BLK-W	Supplied with stainless steel mounting screws and gasket	PBC100WH	–	–	–
Single-gang horizontal covers (nonmetallic)					
WPCV-DUP-H-G	Duplex receptacle	–	–	–	–
WPCV-GFI-H-G	GFCI horizontal	–	–	–	–
Two-gang covers (nonmetallic)					
WPCV2-DUP-G	Double duplex	–	–	–	–
WPCV2-TOG-G	Double toggle	PTC200GY	–	–	–
WPCV2-BLK-G	Supplied with stainless steel mounting screws and gasket	PBC200GY	–	–	–
WPCV2-GFISWG	Combination toggle/GFCI	PTC521GY	–	–	–
WPCV2-DUPSWG	Combination toggle/duplex receptacle	–	–	–	–

Cross reference

Cat. no.	Description	Taymac/Hubbell/ Bell catalog number	RAB	EATON Crouse- Hinds Cooper Industries	Intermatic
Lampholder with round covers – internal gasket (nonmetallic)					
WPRB-T050-G	Grey	PRB57550GY	-	-	-
WPRB-T050-W	White	PRB57550WH	-	-	-