

Access floor modules



Steel City access floor modules from ABB eliminate the clutter of power, voice and data lines by keeping everything out of sight but conveniently close at hand. Our easy-to-install access floor modules are designed to blend with any decor, while providing the durability and versatility you need to meet the growing demands of today's high-tech offices.

You can use our access floor modules with virtually any type of raised floor. Our system is designed to provide a simple, strong and adaptable solution to even the most demanding wire-management needs.

Range of box sizes designed to meet the needs of any application. Now and later.

With five sizes to choose from, our access floor modules handle a broad range of wiring needs, from single power lines to complex data and voice systems. In fact, our largest unit offers 325 cu. in. of space. And, because our modules are easy to install and relocate, you can easily change box sizes or reposition modules as office configurations change.

New, low-profile box fits right in with shallower raised floors.

For installations where shallower raised floors are needed, ABB has developed a low-profile access floor modules to provide the same accessibility and convenience where space is at a premium. Just 2½-inches deep, it can still accommodate a variety of power, voice and data connections.

Wide variety of interchangeable power and data panels adapt to changing demands.

Our extensive line of panels and connection devices maximizes the versatility of our access floor modules. All our panels are designed to be easy to connect, disconnect and rearrange to reduce on-site installation time. And ABB is continually developing new configurations to meet the requirements of virtually any installation, especially for the fast-growing needs of voice and data communication.

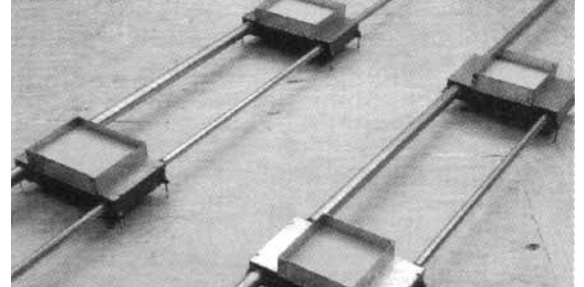

Durable, solid steel covers support heavy loads to protect important connections.

We've reinforced the resilient nylon covers of our modules with a ½" steel plate to prevent buckling under heavy furniture and equipment. The beveled sides enable quick and unobstructed installation in the raised floor.

In addition, our retractable exit not only helps prevent tripping, but protects cable connections by sealing out dust and debris. And, as with all ABB products, our access floor modules are constructed to meet your high standards for durability, safety and reliability.

Steel City access floor modules provide outstanding performance without standing out.

The hinged service top on our modules sits flush with the floor and provides complete access to the connections within. The nylon frame comes in grey, brown, beige and black.





Our access floor modules keep wire connections close at hand but not under foot. The wide variety of box sizes, panels and devices provides exceptional versatility for changing office needs.

Look below the surface and see how Steel City Access floor modules can manage all your power, voice and data connections – today and tomorrow.

AFM-2 Series access floor module

Nonmetallic covers included

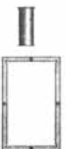

AFM	Power panels	
AFM-2- BLK AFM-2- GRY AFM-2- BRN AFM-2- BGE	AFP-2A* Single duplex	AFP-2B Single duplex
		
Data panel	Accessories	
AFD-2 3RJ 3 T&B Omnijacks or Keystone-style jacks	AFT-2 Power tunnel	
	AFR-2** Mounting trim	

* (1) supplied with box.

** Used to correct opening in floor. Not required for all installations.

AFM-2 Access floor module

Access floor module size	AFM-2
AFM depth	4"
Access floor cut-out	7 ¹ / ₈ " x 4 ¹ / ₈ "
AFM cover size	6 ³ / ₄ " x 3 ⁷ / ₈ "
AFM cover access area	17 sq. in.
Box volume (less panels)	75 cu. in.
Device compartment volume – 45° power	16.2 cu. in.
Base opening	—

* Special panels available — consult factory.
** Devices not included.



Access floor module size	AFM-2
Power panel included**	AFP-2A
Closure panel included	—
Cover/carpet flange material	Polycarbonate
Body material	14-ga. galvanized steel
Prewiring available	Yes*
Max. no. of device panels	2

Diagrams

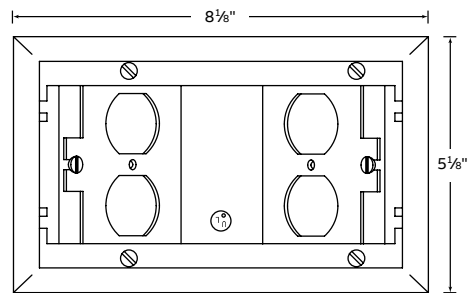
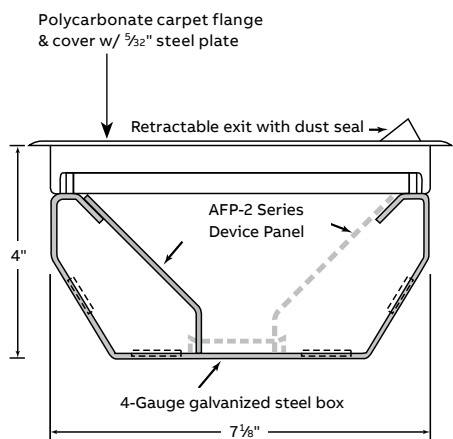

AFM-2
Shown with supplied power panel and optional panel (sold separately).

AFM-2 Series access floor module

Metallic covers included



AFM-2 Access floor module



Access floor module size	AFM-2
AFM depth	4"
Access floor cut-out	7 ¹ / ₈ " x 4 ¹ / ₈ "
AFM cover size	6 ³ / ₄ " x 3 ⁷ / ₈ "
AFM cover access area	17 sq. in.
Box volume (less panels)	75 cu. in.
Device compartment volume	16.2 cu. in.
Base opening	—

Access floor module size	AFM-2
Power panel included**	AFP-2A
Closure panel included	—
Cover/carpet flange material	Brass, Aluminum
Body material	14-ga. galvanized steel
Prewiring available	Yes*
Max. no. of device panels	2

* Special panels available — consult factory.

** See previous page for device plates and accessories.

Diagrams

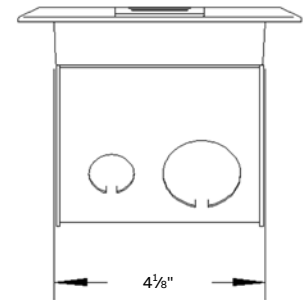
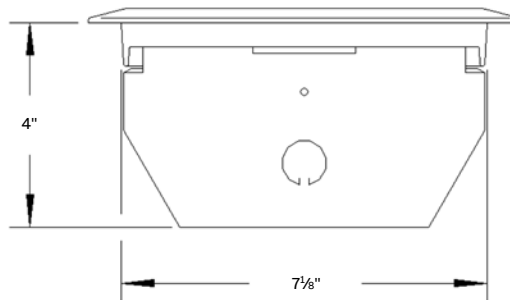
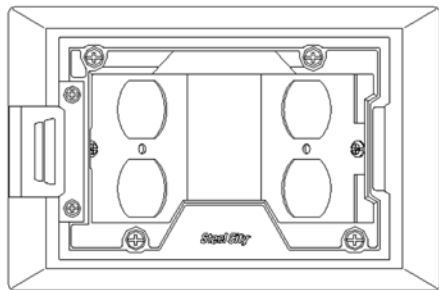

AFM-2 Series raised floor boxes

Cat. No.	Description	Std. Ctn.
AFM-2-BRS	AFM-2 raised floor box, 2 compartment, solid brass cover	1
AFM-2-ALM	AFM-2 raised floor box, 2 compartment, solid aluminum cover	1

For additional device plate options see previous page.

AFM-4 Series access floor module

Nonmetallic covers included

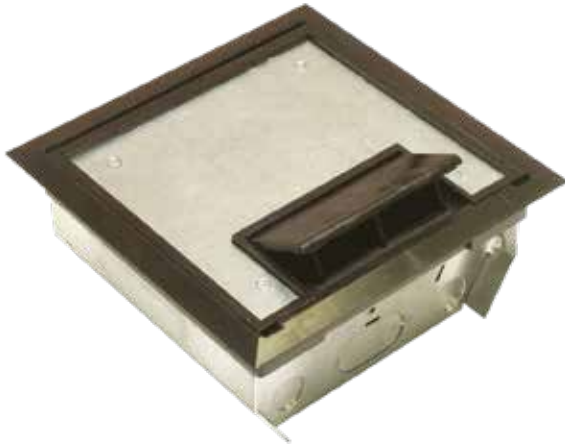

AFM	Power panels		
AFM-4- BLK AFM-4- GRY AFM-4- BRN AFM-4- BGE	AFP-4A* Single duplex - 45°	AFP-4A60 Single duplex - 60°	AFP4GFCI Single GFCI - 60°
	AFP-4B Blank - 45°	AFP-4B60 Blank - 60°	AFP-4-GFCI-45 Single GFCI - 45°

* (1) supplied with box.

Data panels		Accessories	
AFD-4A Single duplex data	AFD-4B Blank	AFT-46 Power tunnel	AFR-4** Trim flange
	AFD-4 4RJ Keystone style jacks	AFC-N Grommeted closure panel	AFM-4EX Extension collar

** Used to correct opening in floor. Not required for all installations.

AFM-4 Access floor module - non metallic covers

Access floor module size		AFM-4
AFM depth		4"
Access floor cut-out		7 ¹⁵ / ₁₆ " x 7 ¹⁵ / ₁₆ "
AFM cover size		7 ⁷ / ₈ " x 7 ⁷ / ₈ "
AFM cover access area		39 sq. in.
Box volume (less panels)		150 cu. in.
Device	45° power	27.3 cu. in.
Compartment	60° power	25.2 cu. in.
Volume	Center data	20.6 cu. in.

* Special panels available – consult factory.
** Devices not included.

Diagrams

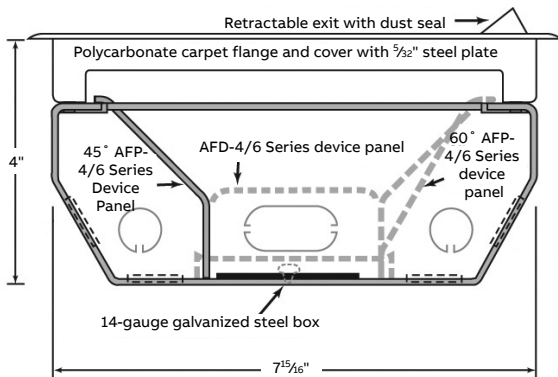

Access floor module size		AFM-4
Base opening		2" x 2 ⁷ / ₈ "
Power panel included**		AFP-4A
Closure panel included		AFC-C
Cover/carpet flange material		Polycarbonate
Body material		14-ga. galvanized steel
Prewiring available		Yes*
Max. no. of device panels		3

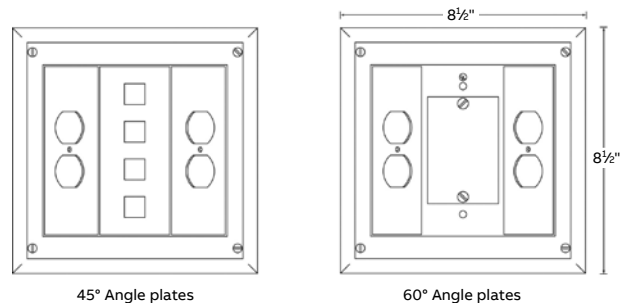

45° Angle plates
Shown with applied power panel and optional data panel and 45° power panel (sold separately).

60° Angle plates
Shown with optional 60° panels (sold separately).

AFM-4 Series access floor module

Metallic covers



AFM-4 Access floor module - metallic covers



Access floor module size	AFM-4
AFM depth	4"
Access floor cut-out	7 ¹⁵ / ₁₆ " x 7 ¹⁵ / ₁₆ "
AFM cover size	7 ⁵ / ₈ " x 7 ⁵ / ₈ "
AFM cover access area	39 sq. in.
Box volume (less panels)	150 cu. in.
Device compartment volume	27.3 cu. in.
	25.2 cu. in.
	20.6 cu. in.

Access floor module size	AFM-4
Base opening	2" x 2 ⁷ / ₈ "
Power panel included**	AFP-4A
Closure panel included	AFC-C
Cover/carpet flange material	Brass, Aluminum
Body material	14-ga. galvanized steel
Prewiring available	Yes*
Max. no. of device panels	3

* Special panels available – consult factory.
 ** Devices not included.
 See previous page for device plates and accessories.

Diagrams

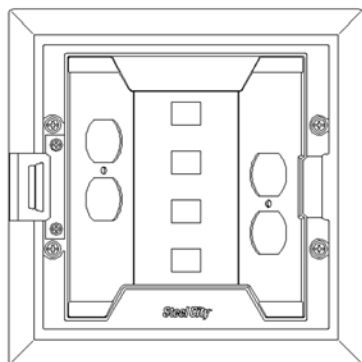

One duplex plate included

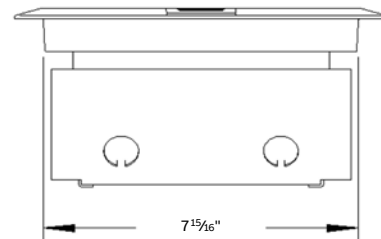
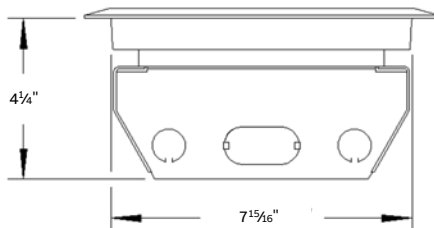

AFM-4 Series raised floor boxes

Cat. No.	Description	Std. Ctn.
AFM-4-BRS	AFM-4 raised floor box, 3 compartment, solid brass cover	1
AFM-4-ALM	AFM-4 raised floor box, 3 compartment, solid aluminum cover	1

AFM-6 Series access floor module

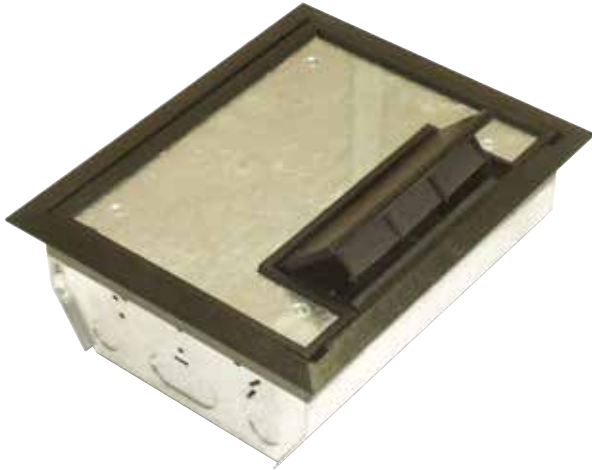

AFM	Power Panels		
AFM-6- BLK AFM-6- GRY AFM-6- BRN AFM-6- BGE	AFP-6Q* Double duplex - 45°	AFP-6B Blank 45°	AFP-6A Single duplex - 45°
	AFP-6B60 Blank - 60°	AFP-6R60 Double duplex - 60°	AFP-6-GFCI Double GFCI - 60°
	AFP-6A60 Single duplex - 60°	AFP-6-GFCI-45 Double GFCI - 45°	

Data Panels		Accessories	
AFD-6Q Double duplex data	AFD-6B Blank	AFT-46 Power tunnel	AFR-6** Trim flange
AFD-6 6RJ T&B Omni jacks or Keystone style jacks	AFD-6A Single duplex	AFC-N Grommeted Closure panel	AFM-6EX Extension collar

* (1) supplied with box.

** Used to correct opening in floor. Not required for all installations.

AFM-6 Access floor module

Access floor module size	AFM-6
AFM depth	4
Access floor cut-out	7 ¹⁵ / ₁₆ " x 10"
AFM cover size	7 ⁵ / ₈ " x 9 ³ / ₄ "
AFM cover access area	60 sq. in.
Box volume (less panels)	225 cu. in.
	45° power 41.5 cu. in.
	60° power 38.3 cu. in.
Device compartment volume	Center data 31.3 cu. in.

* Special panels available – consult factory.

** Devices not included.

Replacement cover: AFM-6-CST-SW black (-BLK), brown (-BRN), beige (-BGE) or grey (-GRY) cover flange.

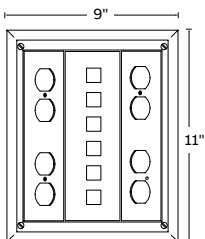

45° angle plates shown with supplied power panel and optional data panel and 45° power panel (sold separately).

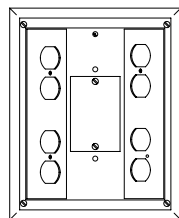

60° angle plates shown with optional 60° panels (sold separately).



Access floor module size	AFM-6
Base opening	2" x 2 ⁷ / ₈ "
Power panel included**	AFP-6Q
Closure panel included	AFC-C
Cover/carpet flange material	Polycarbonate
Body material	14-ga. galvanized steel
Prewiring available	Yes*
Max. no. of device panels	3

Diagrams

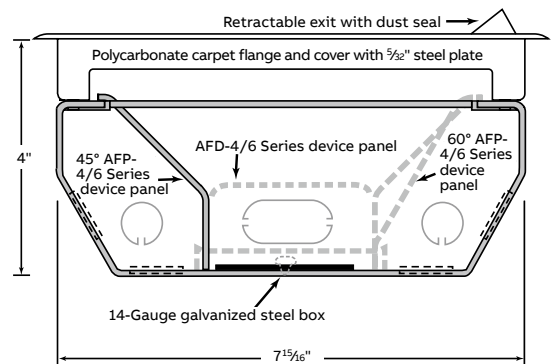

AFM-6S2 Series access floor module



AFM	Power Panels	
AFM-6S- BLK	AFP-6S2-R (-L)* Single duplex R-right side; L-left side)	AFP-6S2-GR (-GL) Single GFCI
AFM-6S- GRY		
AFM-6S- BRN		
AFM-6S- BGE		
	AFP-6S2-BR (-BL) Blank	

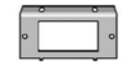
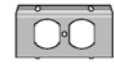

Data Panels	Accessories
AFD-6S2-2RJ T&B Omni jacks or Keystone-style jacks	AFP-6S2-L Mounting flange
AFP-6S2-BR Blank	

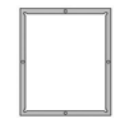

* (1) AFP-6S2-R & (1) AFP-6S2-L supplied with box.
 ** Used to correct opening in floor. Not required for all installations.

AFM-6S2 Access floor module

Access floor module size	AFM-6S
AFM depth	2 1/2"
Access floor cut-out	7 15/16" x 10"
AFM cover size	7 5/8" x 9 3/4"
AFM cover access area	60 sq. in.
Box volume (less panels)	172 cu. in.
Device compartment volume	Power 13.1 cu. in. Data 6.6 cu. in.

* Special panels available – consult factory.
 ** Devices not included.
Replacement cover: AFM-6-CST-SW black (-BLK), brown (-BRN), beige (-BGE) or grey (-GRY) cover flange.

Access floor module size	AFM-6S
Base opening	—
Power panel included**	AFP-6S2-L, AFP-6S2-R
Wire tunnel included	—
Cover/carpet flange material	Polycarbonate
Body material	14-ga. galvanized steel
Prewiring available	Yes*
Max. no. of device panels	4



Diagrams

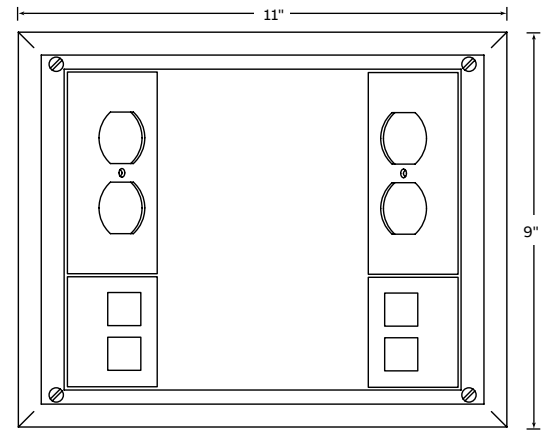
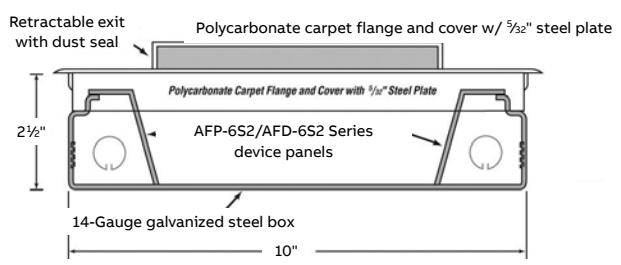

AFM-6S2
 Shown with supplied power panels and optional data panels (sold separately).

AFM-6V Series access floor module



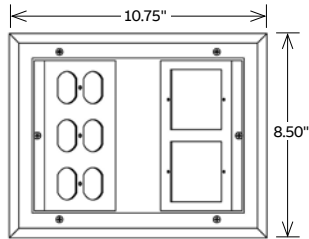
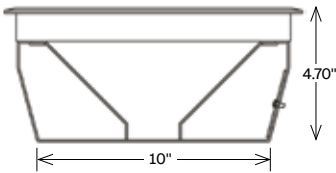

Diagrams

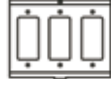

AFM-6
Shown with supplied power panels and optional panels
(sold separately)

AFM	Power panels	
AFM-6V- BLK	AFP-6V-3D*	AFP-6V-3G*
AFM-6V- GRY	Three duplex	Three GFCI
AFM-6V- BRN		
AFM-6V- BGE		

Data Panels	Accessories
AFD-6V-2F*	AFR-6**
Two single gang data face plates	Mounting flange
	

- * Not CSA Certified.
- (1) AFP-6V-3D and (1) AFD-6V-2F supplied with box
- ** Used to correct opening in floor. Not required for all installations.

AFM-6V Access floor module

Access floor module size	AFM-6V	
AFM depth	4.70 in.	
Access floor cut-out	7 ¹⁵ / ₁₆ " x 10"	
AFM cover size	7 ⁵ / ₈ " x 9 ³ / ₄ "	
AFM cover access area	60 sq. in.	
Box volume (less panels)	201 cu. in.	
Device compartment volume	45° power	—
	60° power	—
	Center Data	—
	Power	51 cu. in.
	Data	51 cu. in.

Devices not included. Cover flange available in Black, Grey, Brown or Beige.
Replacement cover: AFM-6-CST-SW black (-BLK), brown (-BRN), beige (-BGE) or grey (-GRY) cover flange.



Access floor module size	AFM-6V
Base opening	1.72 in. x 5.28 in.
Data panel included	AFD-6V-2F
Power panel included	AFP-6V-3D
Closure panel included	Yes
Cover/carpet flange material	Nylon-6
Body Material	14 gauge galvanized steel
Max. no. of device panels	2

AFM-8 Series access floor module

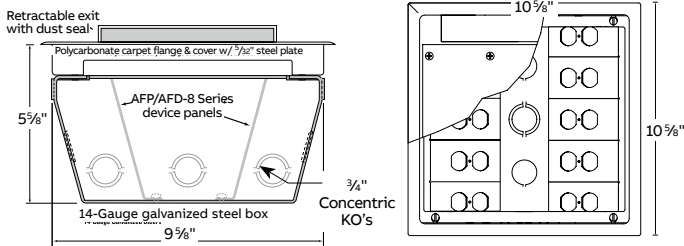
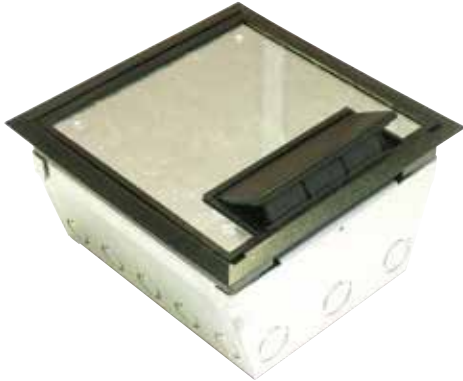





AFM-8
Shown with optional power panels (sold separately). Accepts 10 device panels.
Each compartment can accept voltage dividers for any combination of power and data (included with device panels).

AFM-8 Access floor module

Access floor module size	AFM-8
AFM depth	5 5/8"
Access floor cut-out	9 5/8" x 9 5/8"
AFM cover size	9 3/8" x 9 3/8"
AFM cover access area	74 sq. in.
Box volume (less panels)	325 cu. in.
Device compartment volume	45° power 60° power Power or data
	15.75 cu. in.

* Special panels available – consult factory.
Replacement covers: see 667 Series covers on page C60

AFM	Power panels	
AFM-8- BLK	AFP-8A*	AFP-8G*
AFM-8- GRY	Single duplex	Single GFCI
AFM-8- BRN		
AFM-8- BGE	AFP-8B	
	Blank	
		

Data Panels	Accessories
AFD-8-3RJ	AFR-8**
Keystone	Mounting flange
	

* Power panels include a voltage partition for use between power and data panels.
** Used to correct opening in floor. Not required for all installations.



Access floor module size	AFM-8
Base opening	—
Power panel included	—
Closure panel included	—
Cover/carpet flange material	Polycarbonate
Body material	14-ga. galvanized steel
Prewiring available	Yes*
Max. no. of device panels	10